

# Tip Guide

Contact Tips for AdvErL EVO



The following symbols and expressions indicate the degree of danger and harm that could result from ignoring the corresponding instructions:



This alerts the user of the possibility of minor or moderate injury or damage to the device.



This informs the user of important points concerning operation or the risk of device damage.

#### Trademarks and Registered Trademarks

Parts of the names of companies, products, services, etc. used in this manual may contain either trademarks or registered trademarks owned by each company.

© 2022 J. MORITA MFG. CORP.

# Table of Contents

<b>Design</b>	<b>4</b>
Description of Contact Tip Name.....	4
Relation between Fiber Core Diameter and Laser Beam Characteristics.....	5
<b>Setup</b>	<b>6</b>
Parts Identification.....	6
Contact Tip Attachment.....	7
<b>Operation</b>	<b>8</b>
Applicable Treatments.....	8
<b>Treatment Guideline</b>	<b>9</b>
How to Use the Treatment Guideline.....	9
Treatment Guideline.....	10
Hard Tissue.....	10
Periodontal Tissue.....	11
Implant.....	13
Soft Tissue.....	14
List of Recommended Contact Tips for Each Treatment.....	16
<b>Tip Lineup</b>	<b>18</b>
C (Caries).....	18
CS (Caries Spray).....	19
PS (Perio Surgery).....	20
PSM (Perio Surgery Metal).....	21
S (Surgery).....	21
R (Root).....	22
P (Perio).....	23
<b>Reprocessing</b>	<b>24</b>
Contact Tips.....	24
<b>Items</b>	<b>26</b>
List of Contact Tips.....	26
List of Handpiece Grips.....	26
List of O-ring Sets.....	27

# Design

## Description of Contact Tip Name

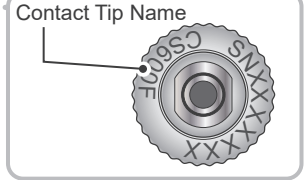
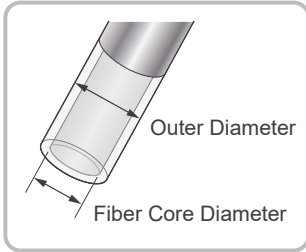

Markings on Contact Tip

# CS 600 F

1

2

3

### 1 Series

- C  
Caries
- CS  
Caries Spray
- PS  
Perio Surgery
- PSM  
Perio Surgery Metal
- S  
Surgery
- R  
Root
- P  
Perio

\* The irradiation pattern of P00FL is the same as C (Caries).

### 2 Fiber Core Diameter

- 200  $\mu\text{m}$  (0.2 mm)<sup>\*1</sup>
- 300  $\mu\text{m}$  (0.3 mm)<sup>\*1</sup>
- 400  $\mu\text{m}$  (0.4 mm)
- 600  $\mu\text{m}$  (0.6 mm)<sup>\*2</sup>
- 800  $\mu\text{m}$  (0.8 mm)

<sup>\*1</sup> For 200  $\mu\text{m}$  and 300  $\mu\text{m}$  tips, use the R handpiece-grip.

<sup>\*2</sup> For PSM600T, the fiber core diameter is 400  $\mu\text{m}$  and is unrelated to the number indicated in the tip name.

### 3 Fiber End Shape

- F  
Flat
- T  
Tapered
- TS  
Tapered Short
- FL  
Flat Long

## Relation between Fiber Core Diameter and Laser Beam Characteristics



A laser beam is a single wavelength light beam that travels in one direction, and its irradiation pattern can be changed by the fiber end shape of the contact tip. For that reason, as the distance from the end of the contact tip increases, the amount of energy per unit area decreases.

The energy density ( $J/cm^2$ ) is inversely proportional to the fiber core diameter. A smaller fiber core diameter has a higher energy density, and a thicker fiber core disperses energy.

This means using a thin fiber core diameter contact tip can vaporize narrow and deep areas, and using a thick fiber core diameter can vaporize wide and shallow areas.

### Examples

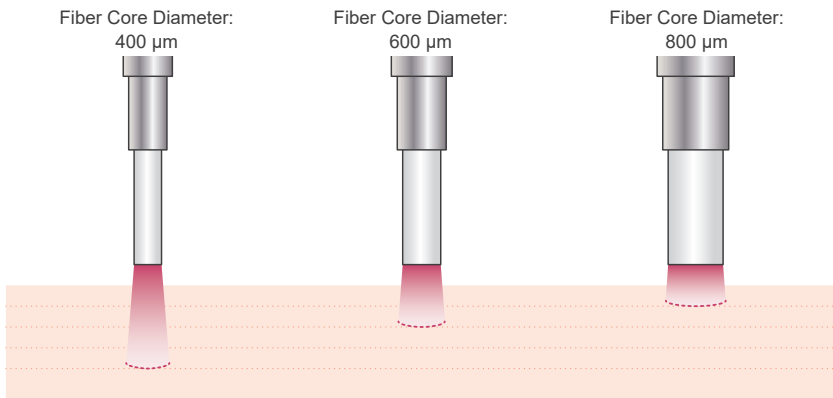

# Setup

## Parts Identification

### Contact Tip

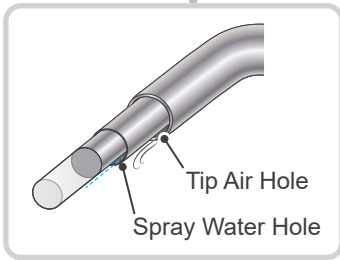
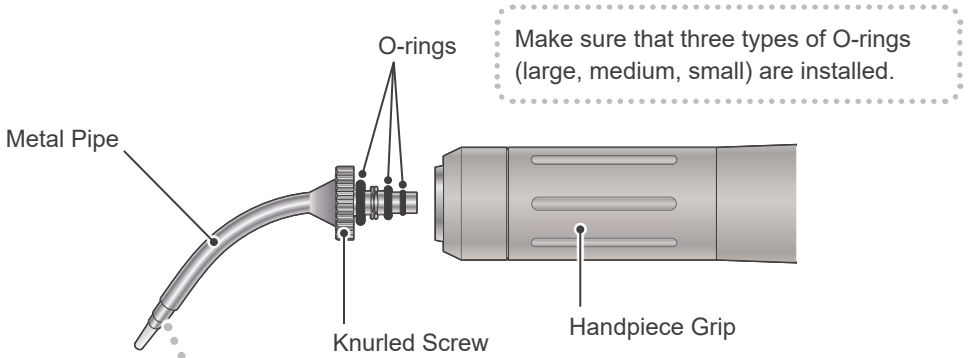

### ⚠ CAUTION

- Turn the tip air off when applying to areas that may cause emphysema or aeroembolism.

- ! Do not excessively press the contact tip against the tooth as it may result in damage to the end of the contact tip or dislocate the metal pipe.

### Handpiece Grip

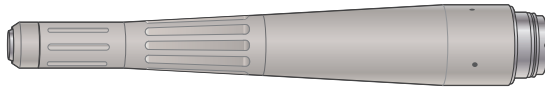

### R Handpiece Grip

(Only for contact tips R200T and R300T.)



## Contact Tip Attachment

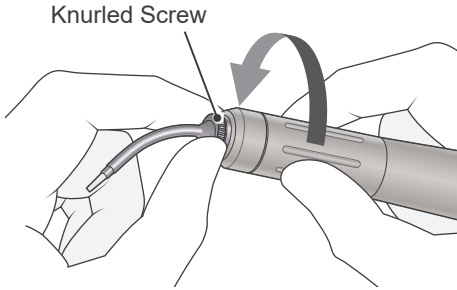

Holding the knurled screw of the contact tip, rotate the handpiece grip to screw the contact tip all the way in.

! Never hold the metal pipe; this could damage the contact tip.

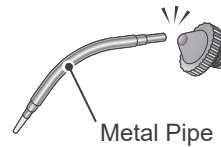

### CAUTION

- Always attach the contact tip while the AdvErL EVO is in “Stand-by” mode or the key switch on the AdvErL EVO is in the “OFF” position.
- Do not emit a laser when the end of the contact tip is dirty; this may result in overheating the contact tip. This is extremely dangerous, especially when turning off the spray water and tip air, as the contact tip generates heat even if there is only a little dirt on it.
- Contact tips are consumable parts. Be sure to perform a pre-use inspection and make sure to replace it with a new one when you find any of the following conditions. Otherwise, the use of worn out contact tips may result in overheating and may burn the patient.
  - If the end of the contact tip is chipped or worn out
  - If the output seems lower than normal
  - If the guide light is dim or does not appear at all
  - If the guide light pattern is different from when it was new

! Do not process (polish, cut, etc.) the end of the contact tip; this may damage the contact tip.

# Operation

## Applicable Treatments

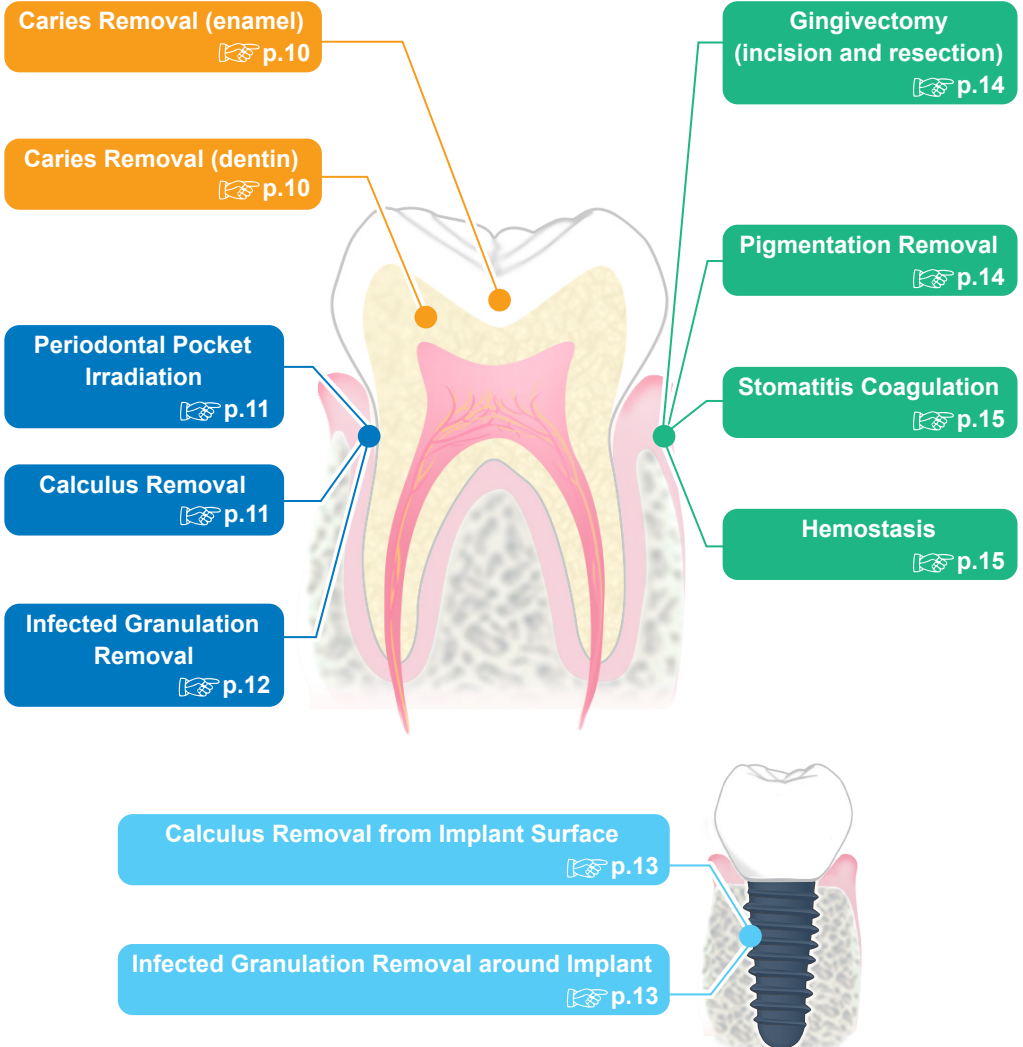



# Treatment Guideline

## How to Use the Treatment Guideline

The following is an example and explanation.

**1** Periodontal Pocket Irradiation

**2**

**3** Contact Tip: PSM600T

**4**

**5** **⚠ CAUTION**  
• Turn the tip air off when applying to areas that may cause emphysema or aeroembolism.

**6** PPS: 20  
mJ: 50  
Spray Water: On (7)  
Tip Air: On (7)

- 1** Treatment name
- 2** Treatment image
- 3** Recommended contact tip (reference information)  
The most suitable contact tip for this treatment among the accessories is listed. For other recommended contact tips, see p.16 "List of Recommended Contact Tips for Each Treatment"  
You can select a contact tip as the occasion demands.
- 4** Laser beam irradiation pattern
- 5** Precautions
- 6** Recommended settings (reference information)  
Adjust the energy level setting as necessary.

# Treatment Guideline



Hard Tissue

Effectiveness: Vaporization

## Caries Removal (enamel)



Contact Tip: CS600 F



PPS: 20

mJ: 100

Spray Water: On

Tip Air: On

## Caries Removal (dentin)



Contact Tip: CS600 F



PPS: 25

mJ: 50

Spray Water: On

Tip Air: On



Scan the QR code for video instruction.

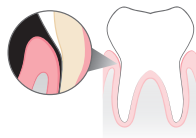

**Periodontal Tissue** **Effectiveness: Incision, Vaporization**

## Periodontal Pocket Irradiation



Contact Tip: PSM600 T



**⚠ CAUTION**

- Turn the tip air off when applying to areas that may cause emphysema or aeroembolism.

PPS: 20  
 mJ: 50  
 Spray Water: On (7)  
 Tip Air: On (7)

## Calculus Removal

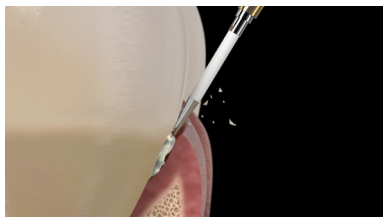

Contact Tip: PS600 T



**⚠ CAUTION**

- Turn the tip air off when applying to areas that may cause emphysema or aeroembolism.

PPS: 20  
 mJ: 50  
 Spray Water: On (7)  
 Tip Air: On (7)

# Treatment Guideline

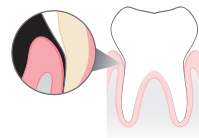

## Infected Granulation Removal

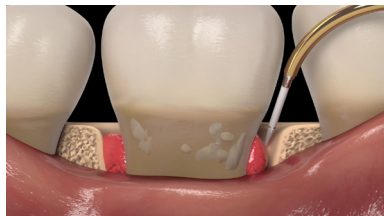

Contact Tip: PS600T



### CAUTION

- Turn the tip air off when applying to areas that may cause emphysema or aeroembolism.

PPS: 20

mJ: 50

Spray Water: On

Tip Air: On



Scan the QR code for video instruction.

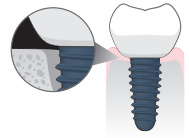

## Implant

Effectiveness: Incision, Vaporization

# Calculus Removal from Implant Surface

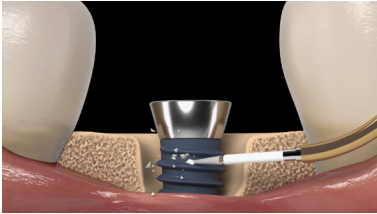

Contact Tip: PS600 T

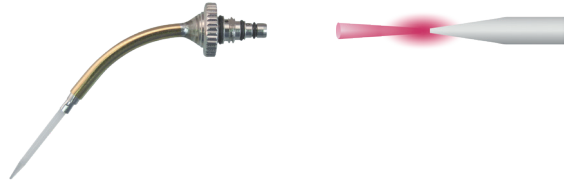

PPS: 20

mJ: 40

Spray Water: On (7)

Tip Air: On (7)

# Infected Granulation Removal around Implant

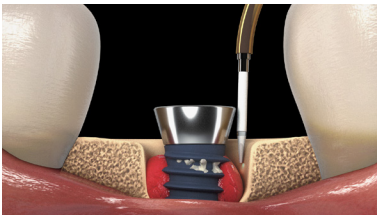

Contact Tip: PS600 T

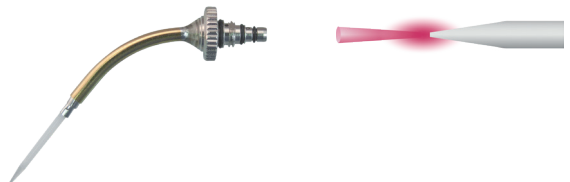

PPS: 20

mJ: 50

Spray Water: On (7)

Tip Air: On (7)

# Treatment Guideline

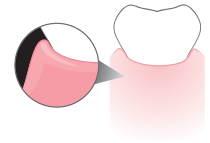

**Soft Tissue**

**Effectiveness: Incision, Hemostasis, Coagulation, Vaporization**

## Gingivectomy (incision and resection)



Contact Tip: S600T



### **⚠ CAUTION**

- Turn the tip air off when applying to areas that may cause emphysema or aeroembolism.

PPS: 20

mJ: 40

Spray Water: On (7)

Tip Air: On (7)

## Pigmentation Removal

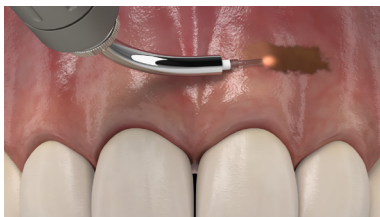

Contact Tip: CS600F



PPS: 20

mJ: 40

Spray Water: On (7)

Tip Air: On (7)



Scan the QR code for video instruction.

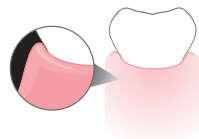

## Stomatitis Coagulation



Contact Tip: CS600 F



PPS: 10  
mJ: 30  
Spray Water: Off  
Tip Air: Off

## Hemostasis

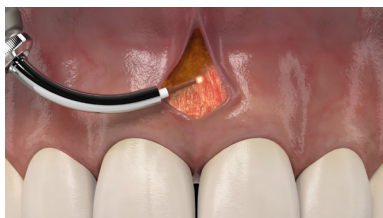

Contact Tip: CS600 F



PPS: 20  
mJ: 40  
Spray Water: Off  
Tip Air: Off

# Treatment Guideline

## List of Recommended Contact Tips for Each Treatment

✓ ... Suitable contact tip for the treatment.

☆ ... Contact tip included with the AdvErL EVO.

		C			CS
		☆ C400F	☆ C600F	☆ C800F	CS600F
Hard Tissue	Caries Removal (enamel)	✓	✓		✓
	Caries Removal (dentin)	✓	✓	✓	✓
Periodontal Tissue	Periodontal Pocket Irradiation	✓			
	Calculus Removal				
	Infected Granulation Removal				
Implant	Calculus Removal from Implant Surface		✓		✓
	Infected Granulation Removal around Implant		✓		✓
Soft Tissue	Gingivectomy (incision and resection)	✓			
	Pigmentation Removal		✓	✓	✓
	Stomatitis Coagulation		✓	✓	✓
	Hemostasis		✓	✓	✓
Reference Page		p. 18			p. 19





PS				PSM	S	R	P		
PS400T	☆ PS400TS	☆ PS600T	☆ PS600TS	PSM600T	☆ S600T	R600T	P400T	P400FL	
								✓	
								✓	
✓	✓	✓	✓	✓		✓	✓		
✓	✓	✓	✓	✓					
✓	✓	✓	✓	✓					
✓	✓	✓	✓			✓			
✓	✓	✓	✓			✓			
✓	✓	✓	✓		✓				
p. 20				p. 21			p. 22	p. 23	

# Tip Lineup

## Tip Lineup

### C (Caries)

#### C400F

Feature: Small fiber core diameter and high energy density.  
Suitable for hard tissues such as enamel.

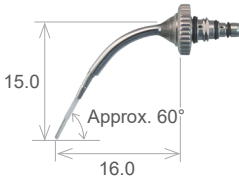

Code No.: 8001909

#### C600F

Feature: Standard tip of the C series.  
Suitable for hard tissue treatment, pigmentation removal for soft tissue, stomatitis coagulation, as well as hemostasis.

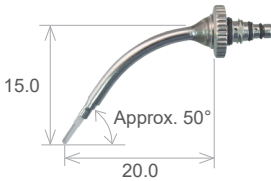

Code No.: 8001906

#### C800F

Feature: Wide fiber core diameter and low energy density.  
Use for wide and shallow vaporization.  
Suitable for pigmentation removal, stomatitis coagulation, as well as hemostasis

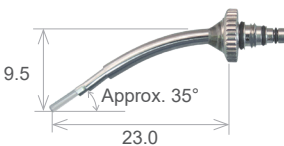

Code No.: 8001905

## CS (Caries Spray)

### CS600F

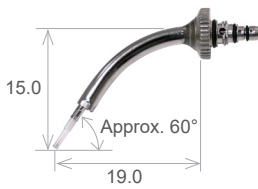

Feature: Spray water has a fine, misty quality so that water is delivered uniformly. Vaporization efficiency is higher than C600F.



Code No.: 8001918

# Tip Lineup

## Tip Lineup

### PS (Perio Surgery)

#### PS400T

Feature: Small fiber core diameter.  
Suitable for narrow periodontal pocket treatment.

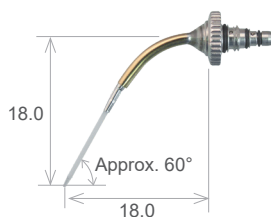

Code No.: 8001917

#### PS400TS

Feature: The fiber length is shorter than PS400T.  
Suitable for narrow periodontal pocket treatment.



Code No.: 8001901

#### PS600T

Feature: Standard tip for the PS series.  
Suitable for entire periodontal tissue treatment.



Code No.: 8001910

## PS600TS

Feature: The fiber length is shorter than PS600 T.  
Suitable for shallow periodontal pocket treatment.



Code No.: 8001902

### PSM (Perio Surgery Metal)

## PSM600T

Feature: Includes a metal sleeve on the tip of the fiber to increase durability against tip breakage.  
Suitable for periodontal tissue treatment.

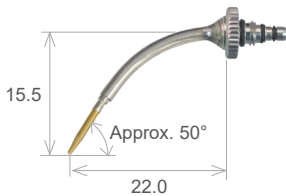

Maximum Energy: 80 mJ

Code No.: 8001920

- ! Do not exceed the maximum energy limit when using PSM600T.
- ! Do not apply excessive force to the tip of the fiber. This could damage the fiber or metal sleeve.

### S (Surgery)

## S600T

Feature: Dedicated for incision and resection of soft tissue.

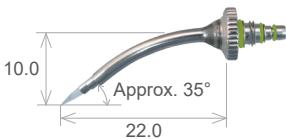

Code No.: 8001907

# Tip Lineup

## Tip Lineup

### R (Root)

#### R200T

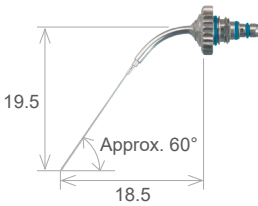

Feature: Approximately 80 % of the laser beam will be dif-fused at 360° toward the side and rear.  
Suitable for treating thin areas.

\* Always attach R200 T to the R handpiece grip.

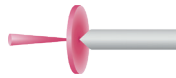

Maximum Energy: 30 mJ  
Code No.: 8001915

! Do not exceed the maximum energy limit when using R200T.

#### R300T

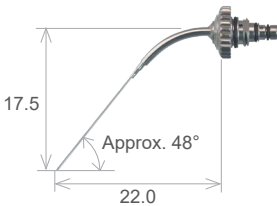

Feature: Approximately 80 % of the laser beam will be dif-fused at 360° toward the side and rear.  
Suitable for treating thin areas.

\* Always attach R200 T to the R handpiece grip.

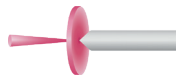

Maximum Energy: 30 mJ  
Code No.: 8001914

! Do not exceed the maximum energy limit when using R200T.

#### R600T

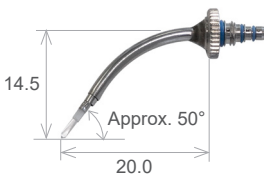

Feature: Approximately 80 % of the laser beam will be dif-fused at 360° toward the side and rear.  
Suitable for treatment around implants and peri-odontal tissue.

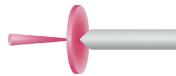

Code No.: 8001919

## P (Perio)

### P400T

Feature: The laser beam is initially focused 0.5 mm ahead of the end of the fiber core, then it diffuses.  
Suitable for narrow periodontal pocket treatment.



Code No.: 8001911

### P400FL

Feature: The fiber length is longer than C400F.  
Suitable for treatment in narrow and deep areas.

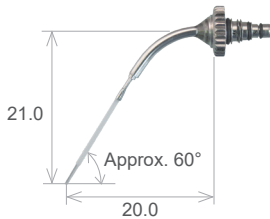

Code No.: 8001912

# Reprocessing

## Contact Tips

Be sure to perform the reprocessing procedures in the following order after use with each patient. (Refer to the accompanying Instructions for Use for the AdvErL EVO.)

### 1 Pre-treatment

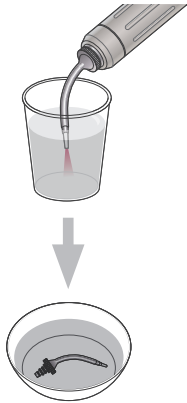

• Enzymatic Detergent

Immerse the fiber area of the contact tip in a container filled with tap water or deionized water, and then emit the laser for approximately 3 to 5 seconds. If there is a lot of debris, emit the laser for 20 to 30 seconds.

#### Recommended Settings

PPS: 25

mJ: 50

Spray Water: On **7**

Tip Air: On **10**

Use enzymatic detergent to clean blood and debris left on the tip of the fiber.

### 2 Cleaning & Disinfection

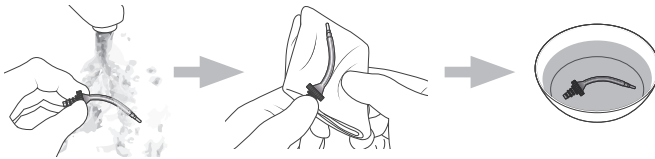

Disinfectants Approved by  
J. MORITA MFG. CORP.

#### Country: U.S.A.

- Ethanol (70 vol% to 80 vol%)
- Chlorhexidine Gluconate

#### Country: Other than U.S.A.

- FD333 forte
- Ethanol (70 vol% to 80 vol%)
- Chlorhexidine Gluconate

Clean the contact tip thoroughly with tap water, then use a soft cloth to wipe off any moisture.

- ❗ Do not clean the contact tip with an ultra sonic cleaning device. This could damage the contact tip.

Disinfect the contact tip with disinfectants approved by J. MORITA MFG. CORP.

- ❗ Do not use disinfectants other than those designated by J. MORITA MFG. CORP.
- ❗ Do not use a washer-disinfector.



# 3

## Packaging

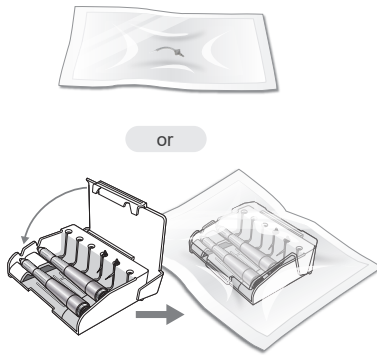

Place the contact tips individually in a sterilization pouch, or store the contact tips in the tip stand and place it in a sterilization pouch.

- ⚠ Use sterilization pouches that conform to ISO 11607.
- ⚠ The end of the contact tip is fragile and easily chipped; handle with care. When using the tip stand, place the end of the contact tip facing down.

# 4

## Sterilization

### Recommended Autoclave Settings

Country: U.S.A.

Sterilizer Type	Temperature	Time
Gravity	+135°C (+275°F)	10 to 15 min

Country: Other than U.S.A.

Sterilizer Type	Temperature	Time
Dynamic Air Removal	+134°C (+273.2°F)	5 min
Gravity	+135°C (+275°F)	5 min

Autoclave the autoclavable parts.

- ⚠ Be sure to complete the clean and disinfection steps before autoclaving the parts.
- ⚠ The setting temperature for sterilization and drying process must be +135°C (+275°F) or lower. If the temperature is set beyond +135°C (+275°F), it may cause damage to or stain the parts.
- ⚠ Do not sterilize the parts by any method other than autoclaving.

# Items

## List of Contact Tips







Series	Name	Code No.	Ref. Page
C	C400F	8001909	p. 18
	C600F	8001906	
	C800F	8001905	
CS	CS600F	8001918	p.19
PS	PS400T	8001917	p. 20
	PS400TS	8001901	
	PS600T	8001910	
	PS600TS	8001902	p. 21
PSM	PSM600T	8001920	
S	S600T	8001907	
R	R200T	8001915	p. 22
	R300T	8001914	
	R600T	8001919	
P	P400T	8001911	p. 23
	P400FL	8001912	

## List of Handpiece Grips

Name	Code No.	Ref. Page
Handpiece Grip	8001733	p.6
R Handpiece Grip	8001736	

## List of O-ring Sets

\* Each set contains three O-rings; one each of large, medium, and small.

Contact Tip	Name	Code No.	Color
C400F	Contact Tip O-ring Black	8001756	
C600F			
C800F			
CS600F			
PS400T			
PS400TS			
PS600T			
PS600TS			
PSM600T			
R300T	Contact Tip O-ring R300T Black	8001758	
R200T	Contact Tip O-ring R200T Blue	8001863	
R600T	Contact Tip O-ring R600T Blue	8001861	
S600T	Contact Tip O-ring S00T Green	8001864	
P400T	Contact Tip O-ring P400T, P600 Red	8001860	
P400FL	Contact Tip O-ring Black	8001756	



Development and Manufacturing

**J. MORITA MFG. CORP.**

680 Higashihama Minami-cho, Fushimi-ku,  
Kyoto 612-8533, Japan  
T +81. (0)75. 611 2141, F +81. (0)75. 622 4595

**Morita Global Website**  
[www.morita.com](http://www.morita.com)

Distribution

**J. MORITA CORP.**

3-33-18 Tarumi-cho, Suita-shi, Osaka 564-8650, Japan  
T +81. (0)6. 6380 1521, F +81. (0)6. 6380 0585

**J. MORITA USA, INC.**

9 Mason, Irvine CA 92618, USA  
T +1. 949. 581 9600, F +1. 949. 581 8811

**J. MORITA EUROPE GMBH**

Justus-von-Liebig-Strasse 27b, 63128 Dietzenbach, Germany  
T +49. (0)6074. 836 0, F +49. (0)6074. 836 299

**MORITA DENTAL ASIA PTE. LTD.**

150 Kampong Ampat #06-01A KA Centre, Singapore 368324  
T +65. 6779. 4795, F +65. 6777. 2279

**J. MORITA CORP. AUSTRALIA & NEW ZEALAND**

Suite 2.05, 247 Coward Street, Mascot NSW 2020, Australia  
T +61. (0)2. 9667 3555, F +61. (0)2. 9667 3577

**J. MORITA CORP. MIDDLE EAST**

4 Tag Al Roasaa, Apartment 902, Saba Pacha 21311 Alexandria, Egypt  
T +20. (0)3. 58 222 94, F +20. (0)3. 58 222 96

**J. MORITA CORP. INDIA**

Felix Office No.908, L.B.S. Marg, Opp. Asian Paints, Bhandup (West), Mumbai 400078, India  
T +91-82-8666-7482

**J. MORITA MFG. CORP. INDONESIA**

28F, DBS Bank Tower, Jl. Prof. Dr. Satrio Kav. 3-5, Jakarta 12940, Indonesia  
T +62-21-2988-8332, F + 62-21-2988-8201

**SIAMDENT CO., LTD.**

71/10 Moo 5 T. Tharkham A. Bangpakong Chachuengsao 24130 Thailand  
T +66 (0) 3857 3042, F +66 (0) 3857 3043

[www.siamdent.com](http://www.siamdent.com)

Diagnostic and Imaging Equipment

Treatment Units

Handpieces and Instruments

Endodontic Systems

Laser Equipment

Laboratory Devices

Educational and Training Systems

Auxiliaries