



i-Dixel WEB

User Manual

(Ver. 2.21)



Thank you for purchasing the i-Dixel WEB software.

For optimum safety and performance, read this manual thoroughly before using the unit and pay close attention to warnings and notes. Keep this manual in a readily accessible place for quick and easy reference.

Keep this manual in a readily accessible place for quick and easy reference.

Trademarks and Registered Trademarks:

Parts of the names of companies, products, services, etc. used in this manual may contain either trademarks or registered trademarks owned by each company.

© 2015 J. MORITA. MFG. CORP.

Be aware of the following points and conditions when using i-Dixel WEB

- * J. MORITA MFG. CORP. owns the copyright for the i-Dixel WEB application, and it may not be copied or used without permission.
- * CT slice images are two-dimensional representations of CT slice data.
Volume-rendered images are two-dimensional representations of CT volume data that appear three-dimensional. MIP images use the Maximum Intensity Projection method to make two-dimensional representations of CT volume data.
RaySum images use the Ray Summation Projection method to make two-dimensional representations of CT volume data.
- * The i-Dixel WEB application does not have some functions which are only available using the conventional i-Dixel application. The functions that are not available are making an image exposure, reconstructing CT volume data, making new CT slices (re-slicing), reconstructing new panoramic data and printing images.
- * i-Dixel WEB can only be used to display and edit images that are in a patient database running on an i-Dixel server computer. It cannot be used for a case database, even if it is running. Furthermore, the i-Dixel server computer must have i-Dixel Ver. 2.2.1.1 or later.
- * Computer terminals and web browsers that are compatible with i-Dixel WEB are noted as “conditions for client systems for the i-Dixel WEB” in the product information section on our home page.
- * Web browser plug-ins etc. could interfere with the operation of i-Dixel WEB, and we recommend that they be turned off. Check settings for Safari plug-ins and Microsoft Edge extensions.
- * If i-Dixel WEB is used with a mouse connected to a Windows10 tablet terminal, the user should also connect a keyboard. Otherwise, the keyboard will not appear in the screen, and it will not be possible to write anything.
- * i-Dixel WEB is not compatible with the Web Notes (hand written input to the web page) that is supported by Microsoft Edge.
- * i-Dixel WEB is not compatible with the InPrivate browsing mode of Microsoft Edge. Even if it starts up, i-Dixel WEB will not function properly.
- * i-Dixel WEB is not compatible with Safari private browser mode. Even if it starts up, it will not function normally.
- * i-Dixel WEB cannot be used when lockdown mode is set in macOS or iPadOS. Even if it starts up, i-Dixel WEB will not function properly.
- * If a web browser’s pop-up blocker is enabled, images and CT data cannot be saved into the specified folder (downloaded files destination) set by the web browser. Turn the pop-up blocker off before using i-Dixel WEB.

Be aware of the following points and conditions when using i-Dixel WEB

- * Using the web browser functions for page display etc. could interfere with proper operation. Always use i-Dixel WEB functions rather than the web browser functions.
- * Depending on the network and computer terminal environment, some pages may fail to load. In this case, click the Refresh button on the web browser, etc. to reload the page.
- * With respect to the i-Dixel WEB application, 2D images are classified as the following i-Dixel modalities: "IntraOral", "Panorama", "PanoramaPlus", "Cephalo", "XII-Still", "Camera", "CT-Scout" and "OtherImage".
- * This manual often tells users to perform operations by right-clicking. However, some computer systems cannot perform right-clicking.
- * Note that length measurements will be slightly erroneous due to the principles for X-ray exposures. This must be taken into consideration to obtain accurate measurements. For details see "17.1. Cautionary remarks for distance measurements" (p. 223).
- * When displaying saved text (Text Overlay), make sure that the specified fonts are installed. Otherwise, text position will be misaligned from the saved position and it may cause a misdiagnosis. Also, keep this in mind when displaying distance and angle measurements.
- * When using an iPad or similar device, operations using the right-click can sometimes be performed by holding down on the relevant spot.
- * When using an iPad or similar device, a stylus pen makes it easier to operate.
- * If, for some reason, i-Dixel WEB freezes, click the Refresh button to reactivate it.
- * J. MORITA MFG. CORP. is not responsible for erratic or random behavior of i-Dixel WEB caused by other applications installed on the computer.
- * New, edited or added information could be lost by closing i-Dixel WEB browser or by pressing the Forward, Back, or Refresh buttons.
- * Follow all laws and guidelines for protecting personal and medical information for the country in which you are operating.
- * Take care that information is not leaked or stolen from the i-Dixel WEB server and client computers to the browser history due hacking and other unauthorized access such as tapping of transmission cables etc.
- * Depending on computer performance, features, and ambient environment (especially the lighting), images may not be adequately displayed.
- * In this manual, CT images may refer to images which united volume rendered images and CT slice images associated with volume rendered images.

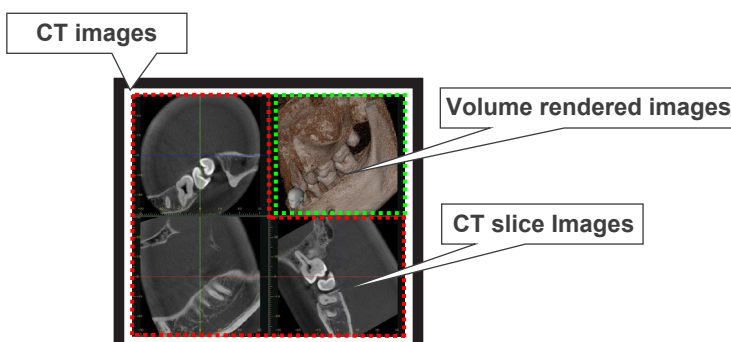

Be aware of the following points and conditions when using i-Dixel WEB

- * A wireless connection to the i-Dixel WEB server can result in the freezing of the application due to transmission signal deficiencies etc. This can sometimes be remedied by refreshing the browser page and re-connecting to the i-Dixel WEB server. Refresh the browser page in the following way.

Refresh Web Page

- For Microsoft Edge

Press the Refresh button: ().

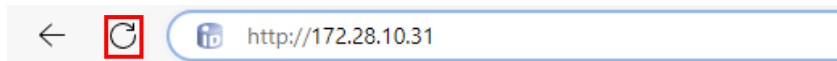

- For iPad Safari

Press the Refresh button: ().

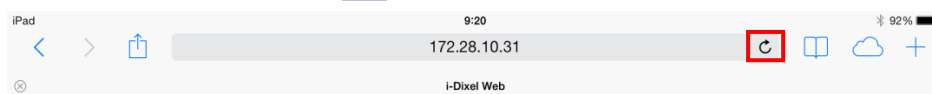

- For Mac OS X Safari

Press the Refresh button: (). Or hold down the Command key and press the R key.

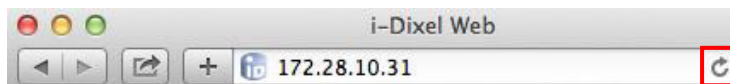

- * Depending on the version of the web browser, images may be distorted. If the degree of distortion is unacceptable, we recommend upgrading to the latest versions for both the computer OS (Operating System) and the web browser.
- * For the iPad web browser, multiple logins will result in multiple window tabs. Clicking one of the tabs will cause the page to be refreshed. Therefore it is best not to login multiple times when using the iPad web browser.
- * If the i-Dixel WEB is executed beyond a day, the connection between the i-Dixel WEB server and the computer will be cut to prevent operation by a third party or leakage of patient information and images etc. To re-connect, refresh the web page and login again. For details on refreshing the Web browser, see "Refresh Web Page" (p. III). For login details, see "3.1. Login" (p. 26).
- * For the iPad, activation of the automatic lock when using the i-Dixel WEB will put the iPad to sleep and cut the connection to the i-Dixel WEB server. To reconnect, release the auto lock, refresh the web page and login again. Furthermore, if the i-Dixel WEB is executed beyond a day before the auto lock takes, the connection to the server will be cut. For details on refreshing the Web browser, see "Refresh Web Page" (p. III). For login details, see "3.1. Login" (p. 26).

Be aware of the following points and conditions when using i-Dixel WEB

- * Leaving the iPad unlocked while it is connected to the i-Dixel WEB server risks unauthorized operation by a third party and leakage of patient information and images etc. To avoid this risk, set the auto lock on the iPad for a reasonable time as described below.

Set Auto Lock for iPad

1. Press the Settings icon on the start-up screen.

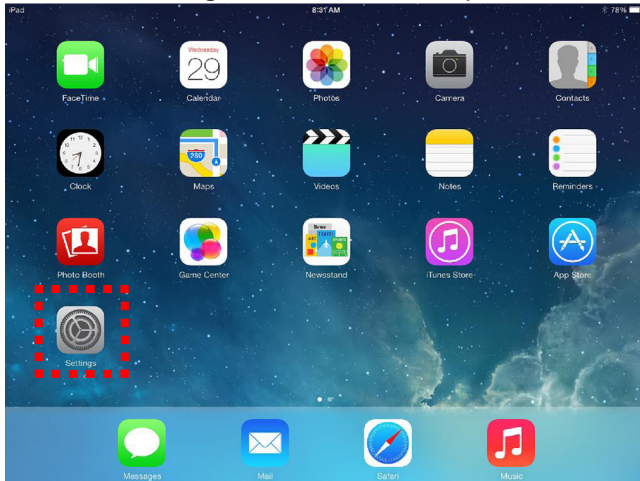

2. Press "Auto-Lock" on the "General Page".

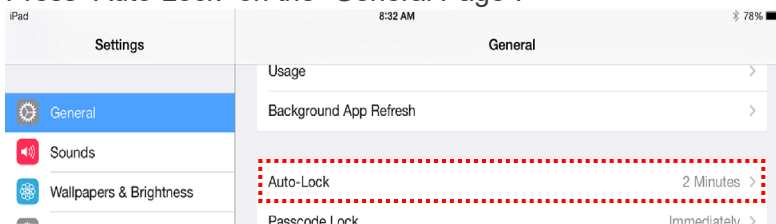

3. Set the time for Auto Lock activation.

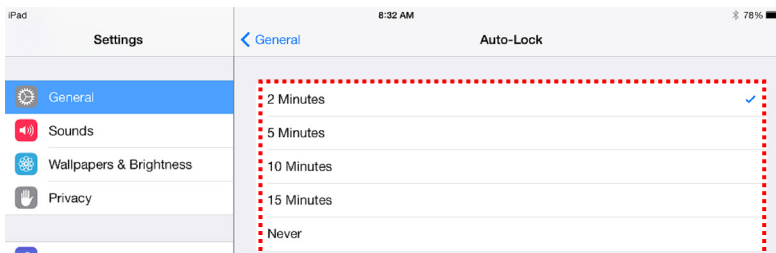

- * Images displayed by the i-Dixel WEB are lossy compression JPEG versions of the original image. The compression ratio is fixed at more than 1:10, as noted in the reference below.

Guidelines for Handling Digital Images, Edition 2.0,
Japan Radiological Society, Electronic Information Committee, April 2006

Also, the original image is saved in the i-Dixel server's database.

- * If you perform the operation of the pinch in and pinch out for the iPad and similar devices, place each of the finger on the screen taking some time. Then, you can perform these operations smoothly.
- * Implant model displayed in the i-Dixel WEB may not correspond to the latest design of the implant model. For the latest design information of the implant, contact your local dealer or implant manufacturer.

CONTENTS

1. Introduction	1
2. Screen Pages.....	2
2.1. Home Page	2
2.2. Main Page	5
2.2.1. 2D Viewer.....	16
2.2.2. 3D Viewer.....	19
2.3. Changing Layout.....	21
3. i-Dixel WEB Login and Logout	26
3.1. Login	26
3.2. Logout.....	27
4. Patient Registration	28
5. Edit Patient Information.....	29
6. Patient Search	30
6.1. Simple Search for Patient Information.....	30
6.2. Detailed Search for Patient Information	32
7. Image Selection.....	34
8. Image Comparison Display	37
9. Import Images.....	51
10. Edit 2D Images.....	56
10.1. Tools	57
10.2. Edit and Save	60
10.3. Expand	64
10.4. Colors.....	68
10.5. Filter	71
10.6. Measurement and Overlays	82
10.7. Part.....	95
10.8. Comment	96
10.9. Additional Information.....	97
10.10. Rotate.....	98
10.11. Crop.....	100
10.12. Statistics	102
11. Edit CT Slice Images	103
11.1. Tools	107
11.2. Save and Edit	112
11.3. Expand	112
11.4. Colors.....	112
11.5. CT	113
11.6. Comment	117
11.7. Additional Information.....	117
12. Edit CT Images.....	118
12.1. Main Panel	123
12.1.1. Edit	123
12.1.2. View.....	126
12.1.3. Tools.....	160
12.1.4. Attitude	181
12.1.5. Volume Cuts.....	182
12.1.6. Annotations List.....	184

12.2. Data Panel	187
12.2.1. Volume Information	187
12.3. Settings Panel	187
12.3.1. Volume Rendering Settings.....	187
12.3.2. Slice Settings.....	191
12.3.3. Filter Settings	192
12.3.4. Other Settings	193
12.3.5. CurvedMPR Settings.....	194
12.3.6. Dual CMPR Settings	197
12.3.7. Saving the Settings	198
13. MWM Linkage	199
13.1. Acquisition of the Worklist	199
13.2. Taking Images	201
13.3. Transfer of an Image to a PACS	203
13.4. Notification that Image-exposure has been completed	204
14. Image Export and PACS Transfer with LinkTo	205
15. Settings	206
15.1. User Preferences	206
15.2. Workstation	208
15.2.1. PatientList View Settings.....	208
15.2.2. Navigation Bar Settings.....	209
15.2.3. Tool Panel Settings	209
15.3. i-Dixel	211
15.3.1. DICOM Settings	211
15.3.2. LinkTo Settings.....	212
15.4. Server	219
16. Error Messages	220
16.1. Connection Lost during Use	220
16.2. Other i-Dixel WEB Server Connection Problems	220
16.3. i-Dixel WEB Access Trouble	222
17. Cautionary Remarks	223
17.1. Cautionary remarks for distance measurements	223
17.1-(1) Computational errors for distance measurements	223
17.1-(2) Measurement errors due to exposure principles	225
18. Application Information	234

1. Introduction

i-Dixel WEB is a software application for using a web browser to select patients and view and edit images that are in a patient database which is running on an i-Dixel server computer.

With i-Dixel WEB, you can logon, search for a patient, and select images for display and editing. This types of images that can be displayed and edited are 2D images, CT slice images, and volume-rendered images. The display differs depending on what type of image is selected.

To login, see “3.1. Login” (p. 26).

To search for a patient, see “6. Patient Search” (p. 30).

To select an image, see “7. Image Selection” (p. 34).

To edit 2D images, see “10. Edit 2D Images” (p. 56).

To edit CT slice images, see “11. Edit CT Slice Images” (p. 103).

To edit CT images, see “12. Edit CT Images” (p. 118).

The volume rendering software included in this application was developed by J. MORITA MFG. CORP. in collaboration with Prof. Kensaku Mori , Nagoya University.

2. Screen Pages

i-Dixel WEB has two main pages: the Home Page and the Main Page.

- Home Page Used to search, select and display patient information.
- Main Page Used to select display and edit images.

2.1. Home Page

The Home Page is displayed after you login.

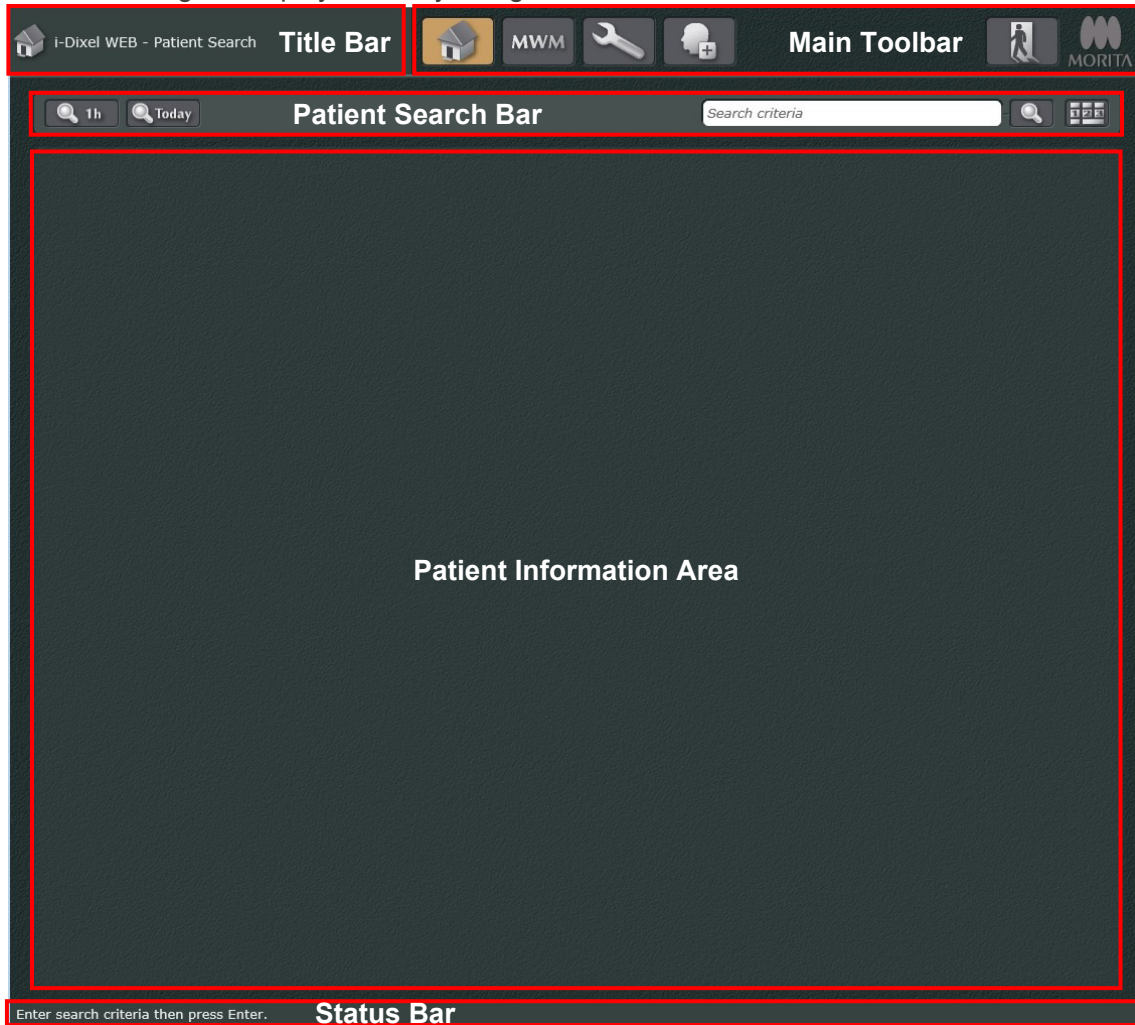

Title Bar:

The following information is displayed.



Main Toolbar:

The following buttons are displayed. The MORITA logo is displayed on the far right.



Return to home page from 2D viewer, 3D viewer or main page

- * When you return to the home page, the patient information area automatically displays the patient list. The patient list is displayed according to the settings in the "Display" view in the Settings and Maintenance Page of i-Dixel on the i-Dixel server computer. Note that when the checkbox of "Show patient / case list automatically" is not selected, the settings will be disabled and the patient list will not be displayed automatically.

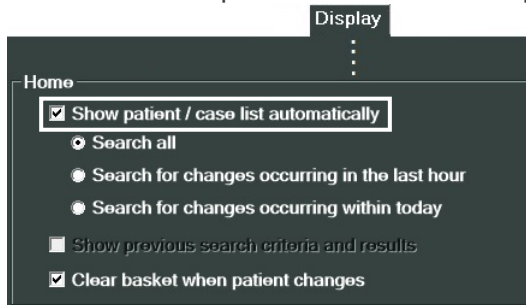

Search all:

Displays all patients.

Search for changes occurring in the last hour:

Displays only patients whose information has been updated within the last 1 hour.

Search for changes occurring within today:

Displays only patients whose information has been updated as of the current day.

The examples of information update include changing of patient name, newly adding or re-editing images.



MWM: To retrieve the order list. Shows the exposure waiting list for HIS/RIS registered patients. For details see "13. MWM Linkage" (p. 199).



Click this to display a settings and maintenance dialogue box. For details see "15. Settings" (p. 206).



Click this to edit patient information.
For details see "4. Patient Registration" (p. 28).



Click this to logout and return to the login page.
For details see "3.2. Logout" (p. 27).



Click the MORITA logo to show the i-Dixel WEB information window.
For details, see "18. Application Information" (p. 234).

Button positions can be changed by dragging to the left of the tool bar.

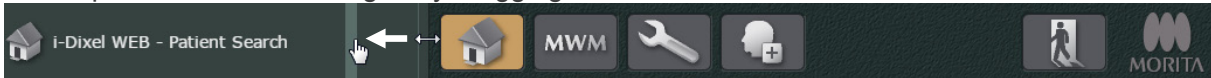

Patient Search Bar:

Enter search information for a patient. See "6. Patient Search" (p. 30).



Click this to display patient information for images etc. updated in the last hour.



Click this to display patient information for images etc. updated today.



Click this to search for patient information corresponding to the entry in the search field.
For details see "6. Patient Search" (p. 30).



Click this to display a keypad for inputting values such as patient ID.

Patient Information Area:

The search results are displayed here.

Status Bar:

Operation guide and current status information are displayed here.

2.2. Main Page

When you select a patient in the home page, the main page will be displayed.
Select images from the image list to open them with the 2D Viewer or 3D Viewer.

The screenshot shows a software interface with the following components:

- 1. Title Bar:** Displays patient information: Morita, Taro 0000000001.
- 2. Main Toolbar:** Contains icons for home, list, search, and TWAIN, along with the MORITA logo.
- 3. Image Search:** A search panel with 'Search Images' and 'Modality' filters. The 'Modality' section includes checkboxes for CT, IntraOral, Panorama, Camera, XII-Movie, XII-Still, Video, Cephalo, OtherImage, CT-Scout, PanoramaPlus, and DR. It also features date range inputs for 'Image created' and 'Study date' (Start and End) and a 'Search' button.
- 4. Image List:** A list of image thumbnails with associated metadata. The list shows five entries, each with a thumbnail and the following details:

Thumbnail	Study	Modality	Created	Modified	Comments
	2005/12/14	IntraOral	2005/12/14 16:06:51	2019/05/13 15:01:17	
	2005/12/14	IntraOral	2005/12/14 16:06:51	2018/04/19 8:50:44	
	2005/12/14	IntraOral	2005/12/14 16:06:52	2018/04/18 15:13:02	
	2005/12/14	IntraOral	2005/12/14 16:08:57	2018/04/19 8:50:44	
	2005/12/14	IntraOral	2005/12/14 16:08:57	2014/10/02 12:58:46	
- 5. Display and Processing Area:** The central workspace for viewing and processing images.
- 6. Image Comparison:** A panel with icons for image comparison.
- 7. Toolbox Area:** A large empty area on the right side of the interface.
- 8. Status Bar:** Located at the bottom, it displays the message: '31 items were found. Click the row to add the image to the basket. Double-click the row to open the image.'

* Items 1 through 8 are always displayed even when the 2D or 3D Viewer is opened.

Title Bar:

Patient's name and ID selected on the home page will display here.
Clicking the title bar displays the following menu.

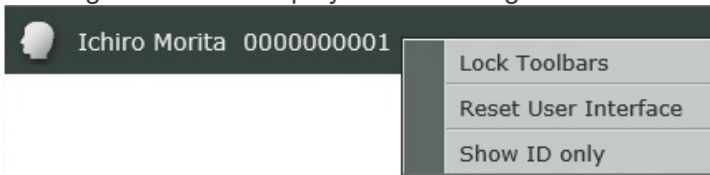

Select "Show ID only" to display only the patient ID in the title bar.
If you select "Show ID only" when only the patient ID is displayed, the title bar displays the patient name and ID.



- * For "Lock Toolbars" and "Reset User Interface" details, see "2.3. Changing Layout" (p. 21).
- * Right-clicking the title bar of the home page also displays the menu.

Note that the format of the patient name displayed on the title bar follows the setting in the "Name sort order" dialog of i-Dixel on the i-Dixel server computer. The "Name sort order" dialog can be displayed from the "Display" view of the Settings and Maintenance page of i-Dixel.

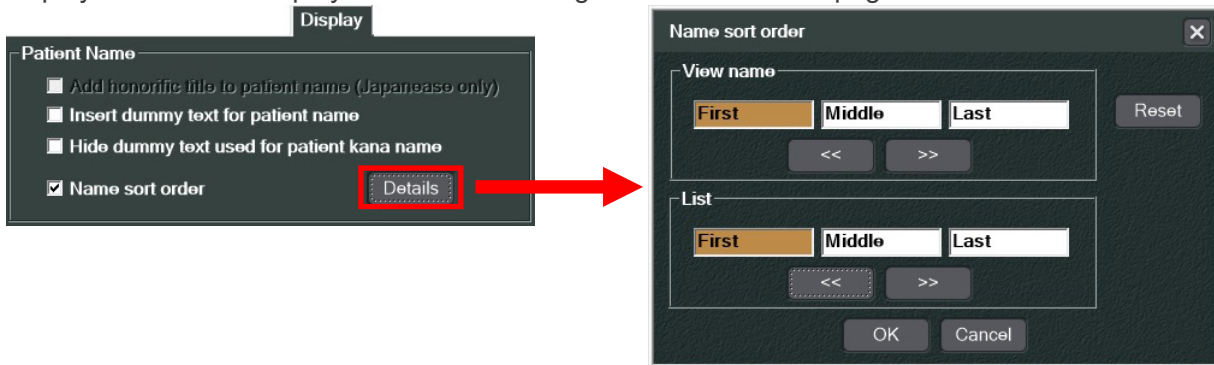

Main Toolbar:

The following buttons are displayed. The MORITA logo is displayed on the far right.



Return to Home page



Show or hide image list and image search fields.



Opens dialog box to edit patient information.
For details see "5. Edit Patient Information" (p. 29).

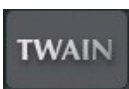

Import images from a TWAIN Device.
For details see "9. Import Images" (p. 51).



Click this to logout and return to the login page.
For details see “3.2. Logout” (p. 27).



Click the MORITA logo to show the i-Dixel WEB information window.
For details, see “18. Application Information” (p. 234).

Button positions can be changed by dragging to the left of the main tool bar.

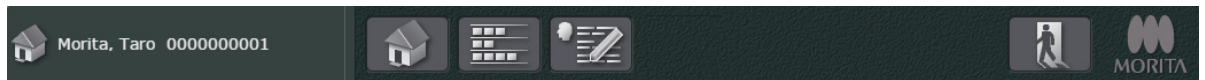

Image Search:

Displays search conditions.
Enter conditions and search for image.
For details see “Image Search” (p. 14).

Image List:

Displays image list for patient.
Any image on the list may be selected
For details see “Image List” (p. 8).

Display and Processing Area:

The area for displaying and processing images.
Images that can be edited with the 2D and 3D viewers can be displayed and processed here.
This is empty when the Main page first appears.

Image Comparison:

Buttons to select an arrangement for the images are displayed here.
For details see “8. Image Comparison Display” (p. 37).

Toolbox:

This shows the tools that can be used in the display and processing area.
For example, if the 2D viewer is being used, the tools for it are listed here.
It is empty when the Main page first appears.

Status Bar:

Operation guide and current status information are displayed here.

Image List

When you select a patient on the home page, the corresponding image list will be displayed. Also image searching options are displayed.

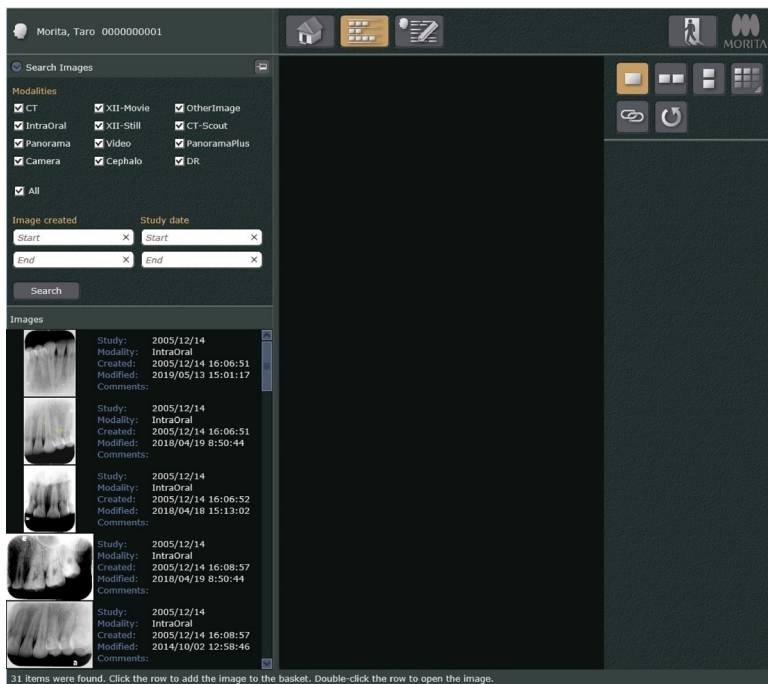
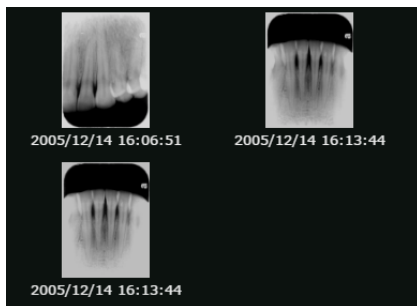

Image List Display Styles

The image list can appear as "Thumbnails", "Tiles" or "Lists".

- Thumbnail



- Tiles

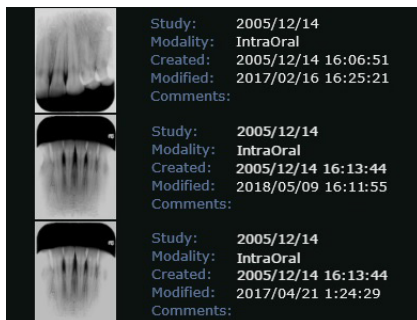

- Lists

Study date	Modality	Image created	Modified	Thumbnail	Comments
2005/12/14	IntraOral	12/14/2005 4:06:51 PM	4/19/2018 8:50:44 AM		
2005/12/14	IntraOral	12/14/2005 4:13:44 PM	2/16/2017 4:25:21 PM		
2005/12/14	IntraOral	12/14/2005 4:13:44 PM	2/16/2017 4:25:21 PM		
2005/12/14	IntraOral	12/14/2005 4:13:43 PM	4/18/2018 3:13:01 PM		

To select a style, right-click inside the image list area and select “View” from the pop-up menu.

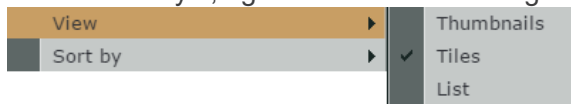

For the “Tiles” style, a pop-up menu with “Show Prompts” will appear. Select “Show Prompts” to show or hide the item names.



Regardless of the display style, the line on the right side of the list may be dragged to change the width of the list area.

Lists Style

Study date	Modality	Image created	Modified	Thumbnail	Comments
2005/12/14	IntraOral	12/14/2005 4:06:51 PM	4/19/2018 8:50:44 AM		
2005/12/14	IntraOral	12/14/2005 4:13:44 PM	2/16/2017 4:25:21 PM		
2005/12/14	IntraOral	12/14/2005 4:13:44 PM	2/16/2017 4:25:21 PM		



Study date	Modality	Image created	Modified	Thumbnail
2005/12/14	IntraOral	12/14/2005 4:06:51 PM	4/19/2018 8:50:44 AM	
2005/12/14	IntraOral	12/14/2005 4:13:44 PM	2/16/2017 4:25:21 PM	
2005/12/14	IntraOral	12/14/2005 4:13:44 PM	2/16/2017 4:25:21 PM	

Rearrange Images

Click inside the image list area to bring up the “Sort by” pop-up menu and then rearrange the images. Images can be sorted by “Study date”, “Modality”, “Image Created”, “Modified”, “Comments” or “Image Information” in ascending or descending order.

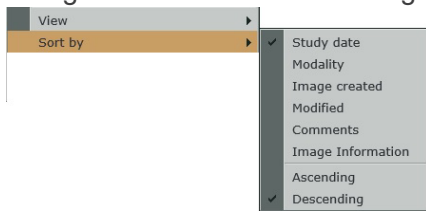

For the “Tiles” style image list, images can be sort in either ascending or descending order by clicking “Study date”.

To sort from latest to earliest

Study date	Modality	Image created	Modified	Thumbnail	Comments
9/10/2014	Panorama	9/10/2014 1:24:54 PM	11/16/2018 2:16:59 PM		
9/10/2014	Pan	9/10/2014 1:24:54 PM	2/20/2017 11:42:33 AM		
8/22/2014	CT	8/22/2014 4:30:36 PM	5/12/2020 5:13:03 PM		
8/22/2014	CT	8/22/2014 4:30:36 PM	10/3/2019 5:15:14 PM		

Click "Study date".



Study date	Modality	Image created	Modified	Thumbnail	Comments
12/14/2005	IntraOral	12/14/2005 4:08:57 PM	10/2/2014 12:58:46 PM		
12/14/2005	IntraOral	12/14/2005 4:13:44 PM	2/16/2017 4:25:21 PM		
12/14/2005	IntraOral	12/14/2005 4:11:17 PM	4/21/2017 1:24:29 AM		
12/14/2005	IntraOral	12/14/2005 4:11:18 PM	4/21/2017 2:56:16 AM		

* Sorting by “Modality” will rearrange the images in the order of modalities: “PanoramaPlus”, “Panorama”, “IntraOral”, “Cephalo”, “CT-Scout”, “CT”, “Camera”, “Video”, and “OtherImage”.

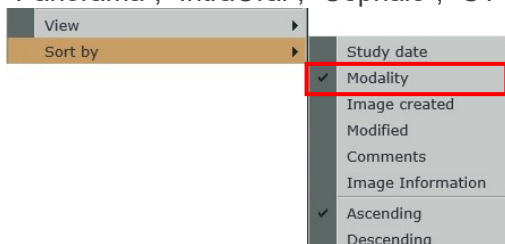

Image List Thumbnails

The following thumbnails appear in the Image List

* The following explanation uses the “Lists” style display.

- 2D Images

All images except for CT modality
E.g., Panorama

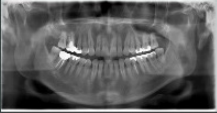
Modality	Image created	Modified	Thumbnail
Panorama	9/10/2014 1:24:54 PM	11/16/2018 2:16:59 PM	

* CT Slice Image Thumbnails Classified as OtherImage
These images are treated as 2D images

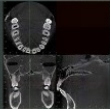
Modality	Image created	Modified	Thumbnail
OtherImage	12/28/2008 10:00:10 AM	11/12/2013 1:16:45 PM	

* CT Image Thumbnails Classified as OtherImage
These images are treated as 2D images

Modality	Image created	Modified	Thumbnail
OtherImage	12/20/2008 10:00:10 AM	11/11/2013 1:16:45 PM	

- CT Slice Image Thumbnail

CT slice image thumbnail classified as CT modality.

Modality	Image created	Modified	Thumbnail
CT	8/22/2014 4:30:36 PM	9/18/2014 2:28:48 PM	

- CT Image Thumbnail

CT image thumbnail classified as CT modality.

Modality	Image created	Modified	Thumbnail
OtherImage	12/20/2008 10:00:10 AM	11/11/2013 1:16:45 PM	

* CT image refers to images which united volume rendered images and CT slice images associated with volume rendered images.

A Symbol Displayed on Thumbnail Image

While editing a 2D image or CT slice images in the 2D Viewer, an asterisk symbol (✱) is displayed on the thumbnail image.

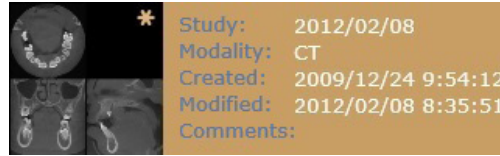
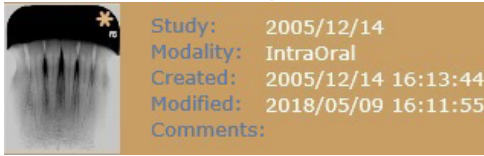

Right-click the thumbnail image, and then click “Save” to overwrite the image.

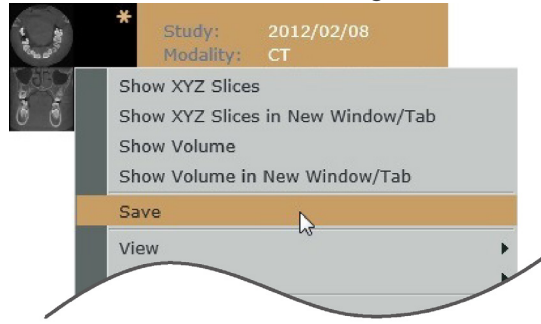

However, while editing a CT image with the 3D Viewer, the asterisk symbol will not appear on the thumbnail image, and the “Save” command is unavailable.

- * Details about how to edit 2D images in the 2D Viewer are described in “10. Edit 2D Images” (p. 56). Details about how to edit CT slice images in the 2D Viewer are described in “11. Edit CT Slice Images” (p. 103).



Deleting 2D Images

For 2D images only, you can delete them in i-Dixel WEB. Right-click a thumbnail image, and then click “Delete Image”.



- * The “Delete Image” menu may not be displayed in the pop-up menu depending on the operation status of the i-Dixel WEB.

Hiding Images and Image Searching Options

Click a Pinned button () and change it to Unpinned button (), so that the thumbnail image list and searching options can be hidden until you close the main page. Moreover, the hidden thumbnail image list and searching options can be redisplayed again by clicking on the bar.

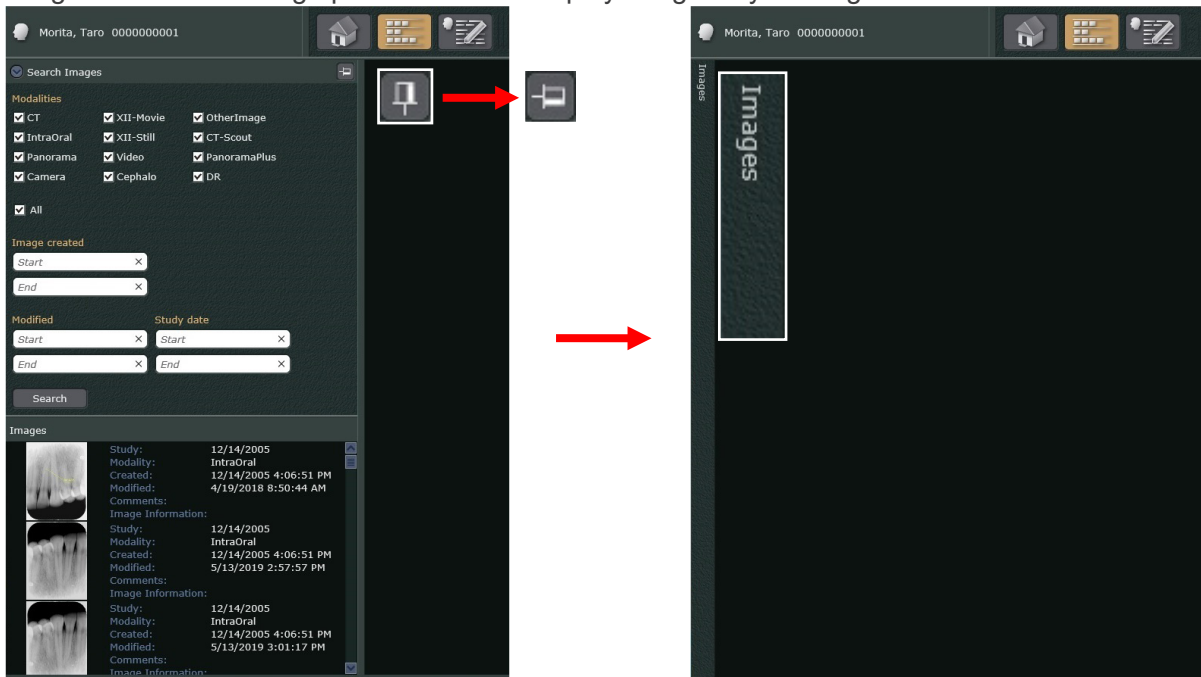

- Redisplaying images and image searching options:
Click the images bar or the Show/Hide button ().
- Hiding images and image searching options again:
Click anywhere other than the thumbnail image list and image searching options areas.

Switching Whether to Display Items

For the “Tiles” style, you can switch whether to display items (study date, etc.).

Example: Hiding “Study date”

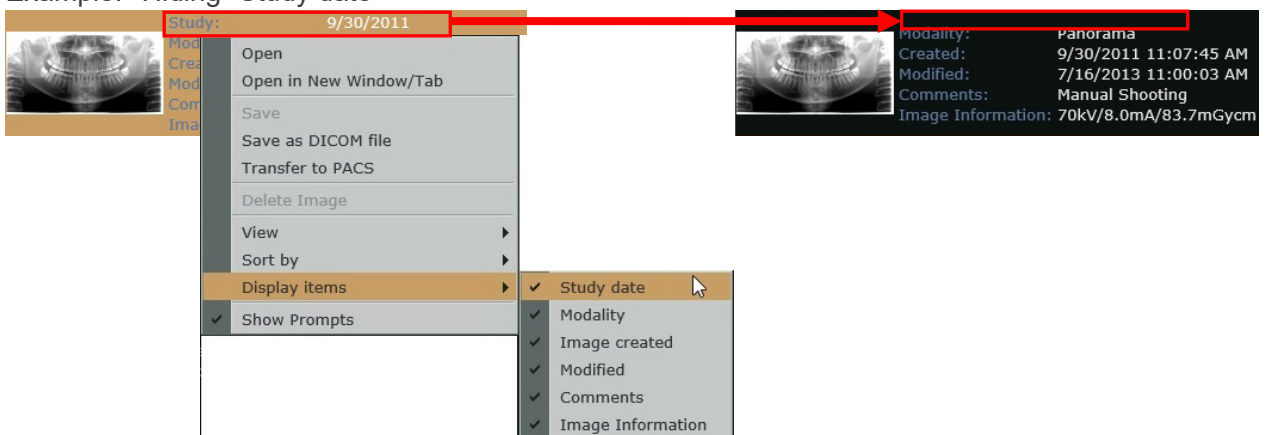

- * The “Image Information” displays the dose information (tube voltage, etc.) during radiography. However, this is not displayed for images without such information. The following shows an example of displaying an image with image information.

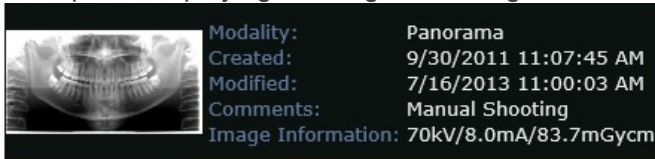

Image Search

Searching for an image in the list

The image search field appears along with the image list

- * The following explanation uses the “Lists” style display.

Image Search Display

The image search field appears along with the image list.

Click the Arrow button, left side of “Search Images” to open its field.

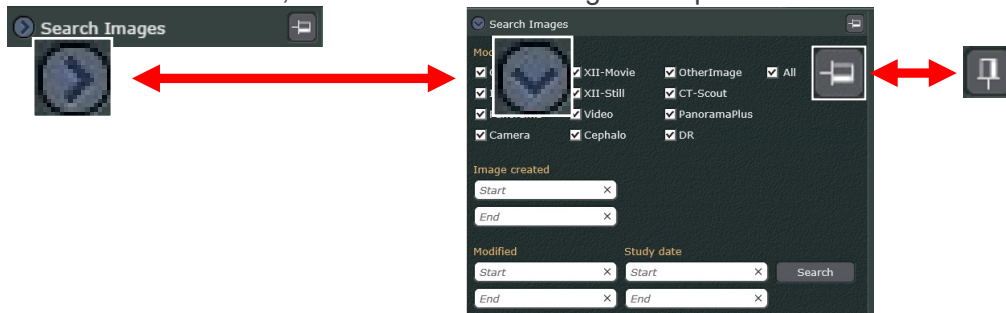

To fix the position of the image search display and thumbnail list to the main page, click the Unpinned button ([-]). (It will change to the Pinned button ([+])).

Doing so will always display the image search display and thumbnail image list until the main page is closed.

Image Search

The image search procedure is shown by the following example.

- * The following explanation uses the “Lists” style display.

Example: Search for images made from January 1, 2001 to January 1, 2021 and classified as IntraOral modality.

- 1) Check “IntraOral” as the Modality.
For the “Study date” enter 1, 1, 2001 for beginning and for the end enter 1, 1, 2021.

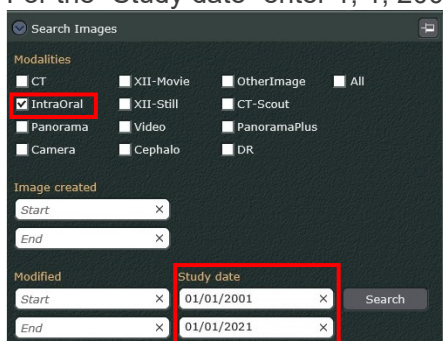

- 2) Click the Search button ().
A list of images will appear.

Search Images

Modalities

CT XII-Movie OtherImage All



IntraOral XII-Still CT-Scout

Panorama Video PanoramaPlus

Camera Cephalo DR

Image created Start End Modified Start End Study date 01/01/2001 01/01/2021 Search

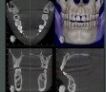
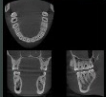
Images

Study date	Modality	Image created	Modified	Thumbnail	Comments
8/22/2014	CT	8/22/2014 4:30:36 PM	10/10/2014 11:39:48 AM		
8/22/2014	CT	8/22/2014 4:30:36 PM	9/18/2014 2:28:48 PM		
11/26/2009	Cephalo	11/26/2009 9:14:03 AM	7/18/2017 10:35:25 AM		
11/26/2009	Cephalo	11/26/2009 9:14:18 AM	9/12/2014 5:51:32 PM		

Search Images

Modalities

CT XII-Movie OtherImage All





IntraOral XII-Still CT-Scout

Panorama Video PanoramaPlus

Camera Cephalo DR

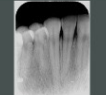
Image created Start End Modified Start End Study date 01/01/2001 01/01/2021 Search

Images

Study date	Modality	Image created	Modified	Thumbnail	Comments
12/14/2005	IntraOral	12/14/2005 4:06:51 PM	5/13/2019 2:57:57 PM		
12/14/2005	IntraOral	12/14/2005 4:13:44 PM	5/9/2018 4:11:55 PM		
12/14/2005	IntraOral	12/14/2005 4:08:57 PM	4/19/2018 8:50:44 AM		
12/14/2005	IntraOral	12/14/2005 4:06:51 PM	4/19/2018 8:50:44 AM		

2.2.1. 2D Viewer

Images selected from the image list can be displayed and edited.
The 2D viewer can display and edit 2D images and CT slices.
The appearance of the 2D viewer depends on the type of image selected.

* Volume rendered images cannot be edited with the 2D viewer.

2D Images

Display 2D images in the 2D viewer in the following ways.

- Double-click the thumbnail.
- Right-click the thumbnail to bring up a pop-up menu and then select “Open”.

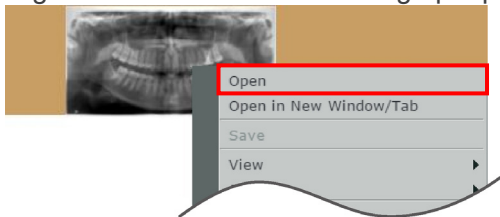

- Right-click the thumbnail to bring up a pop-up menu and then select “Open in New Window/Tab”.

A new tab will appear on the Web browser. The 2D viewer will display the image in this new tab.

However for some tablet computers like the iPad, the “Open in New Window/Tab” will not appear.



- * For the “Tiles” and “Lists” style image list, “Open” and “Open in New Window/Tab” can be selected by right-clicking any place on the line for the thumbnail.
- * The thumbnails for CT slices and volume rendered images that are classified as OtherImage can be used to display the image in the same way. These images will appear as 2D images as they appear in their thumbnails.

Example: 2D Image Display

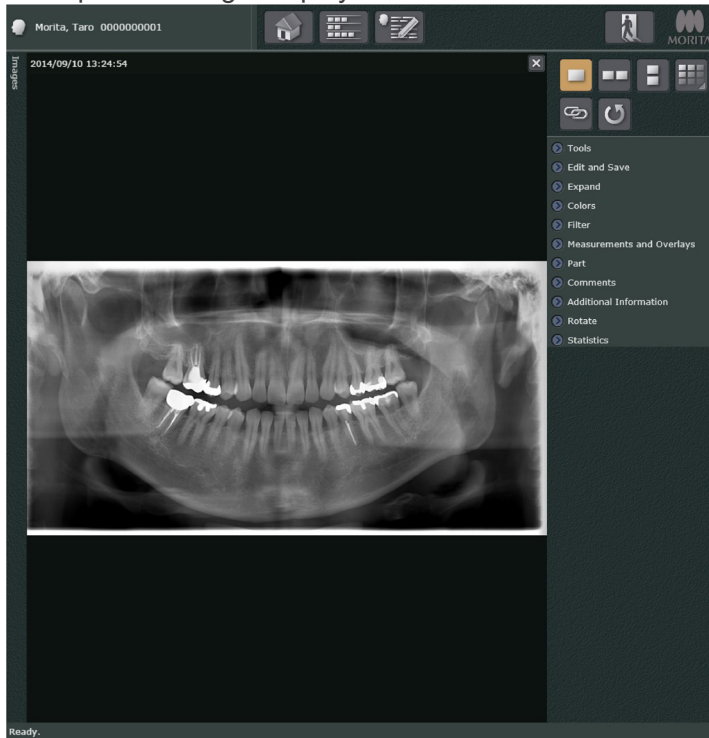

* Display CT image in 2D Viewer

CT images can be displayed in the 2D Viewer by manipulating a CT images thumbnail classified as a CT modality image in any of the above noted ways.

- CT image refers to images which united volume rendered images and CT slice images associated with volume rendered images.
- For CT images thumbnails classified as CT modality images, see “Image List Thumbnails, CT Image Thumbnail” (p. 11).

Example: Display CT Image as 2D Image

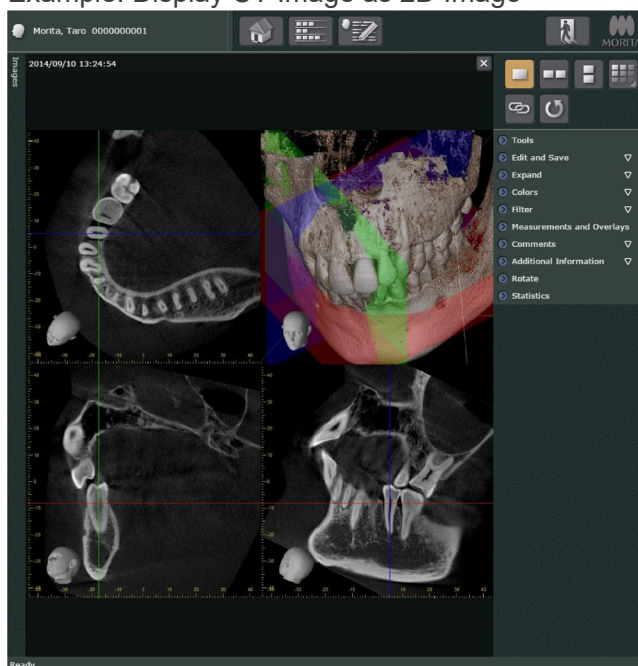

CT Slice Images

CT slices can be displayed in the 2D viewer in the following ways.

- Right-click the thumbnail for a CT slice image and select “Show XYZ Slices” from the pop-up menu.

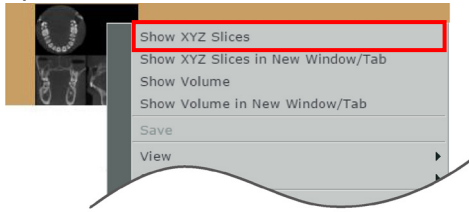

- Right-click the thumbnail for a CT slice image and select “Show XYZ Slices in New Window/Tab” from the pop-up menu. A new tab will appear on the Web browser. The 2D viewer will display the image in this new tab. However for some tablet computers like the iPad, the “Show XYZ Slices in New Window/Tab” will not appear.

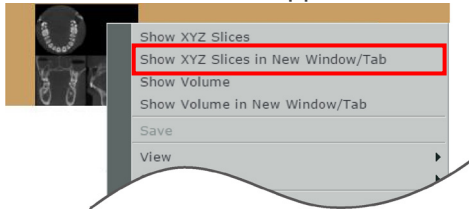

- * For the “Tiles” and “Lists” style image list, “Show XYZ Slices” and “Show XYZ Slices in New Window/Tab” can be selected by right-clicking any place on the line for the thumbnail.

Example: CT Slice Image Display

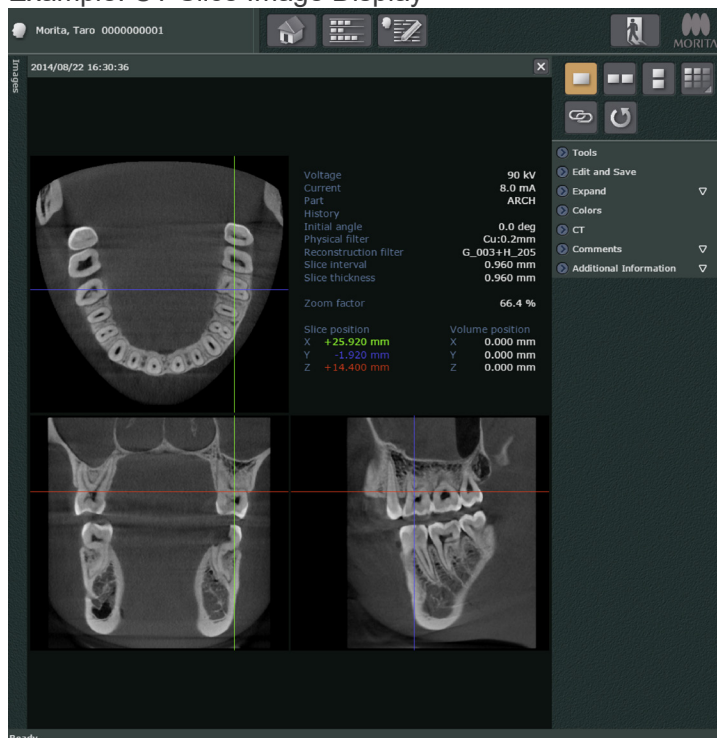

2.2.2. 3D Viewer

CT images select from the image list can be displayed and edited.
The 3D viewer only displays and edits CT images.

- * 2D images cannot be viewed with the 3D Viewer.
- * CT image refers to both volume rendered images and the CT slices linked to them.

Display CT images in the 3D viewer in the following ways.

- Double-click the thumbnail for a CT image.
- Right-click the thumbnail for a CT slice image and select “Show Volume” from the pop-up menu.

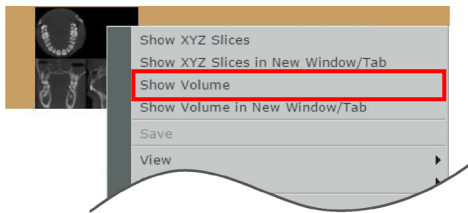

- Right-click the thumbnail for a CT slice image and select “Show Volume in New Window/Tab” from the pop-up menu.

A new tab will appear on the Web browser. The 3D viewer will display the image in this new tab.

However for some tablet computers like the iPad, the “Show Volume in New Window/Tab” will not appear.

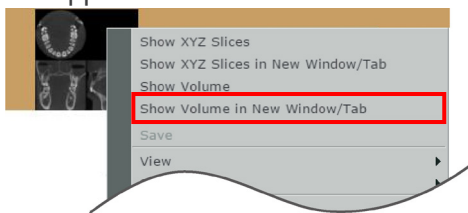

- * For the “Tiles” and “Lists” style image list, “Show Volume” and “Show Volume in New Window/Tab” can be selected by right-clicking any place on the line for the CT thumbnail.

Example: CT Images Display

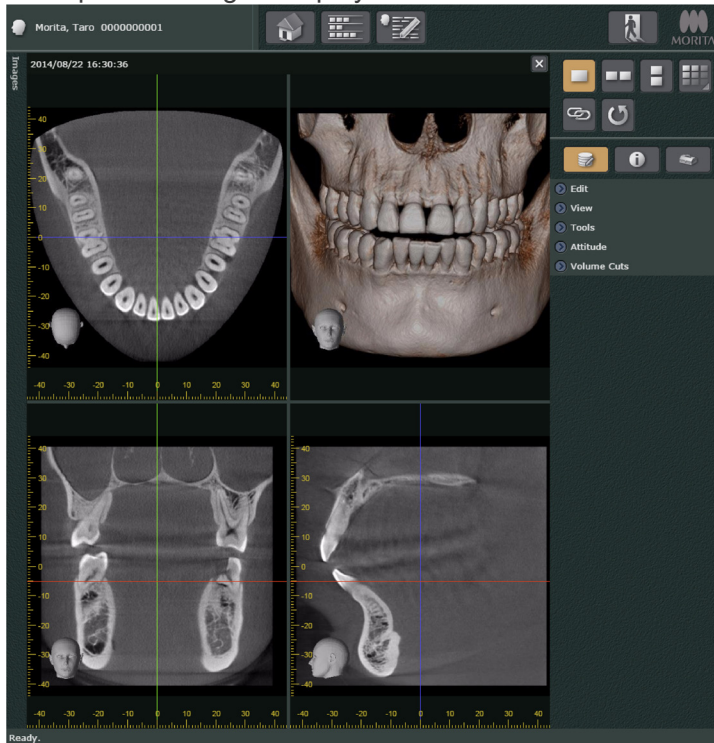

Use a CT slice image thumbnail to display a CT image in the 3D Viewer

Use any of the above ways to display a CT image in the 3D Viewer as long as the image is associated to CT volume data and CT slice data and the thumbnail for the CT slice image is classified as a CT modality image.

- * CT image refers to images which united volume rendered images and CT slice images associated with volume rendered images.
- * For CT images thumbnails classified as CT modality images, see “Image List Thumbnails, CT Image Thumbnail” (p. 11).

2.3. Changing Layout

Layout of the title bar, main toolbar, and status bar for the home page and main page can be changed.

Layout of the image comparison panel and the toolbox for the main page can be changed.

Example: How to change the title bar layout.



1. Right-click the title bar, and then click “Lock Toolbars” to cancel selection.

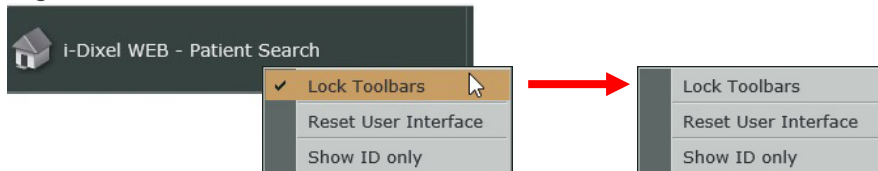

2. Drag the title bar. Triangle marks will appear in the places where the title bar can be set.

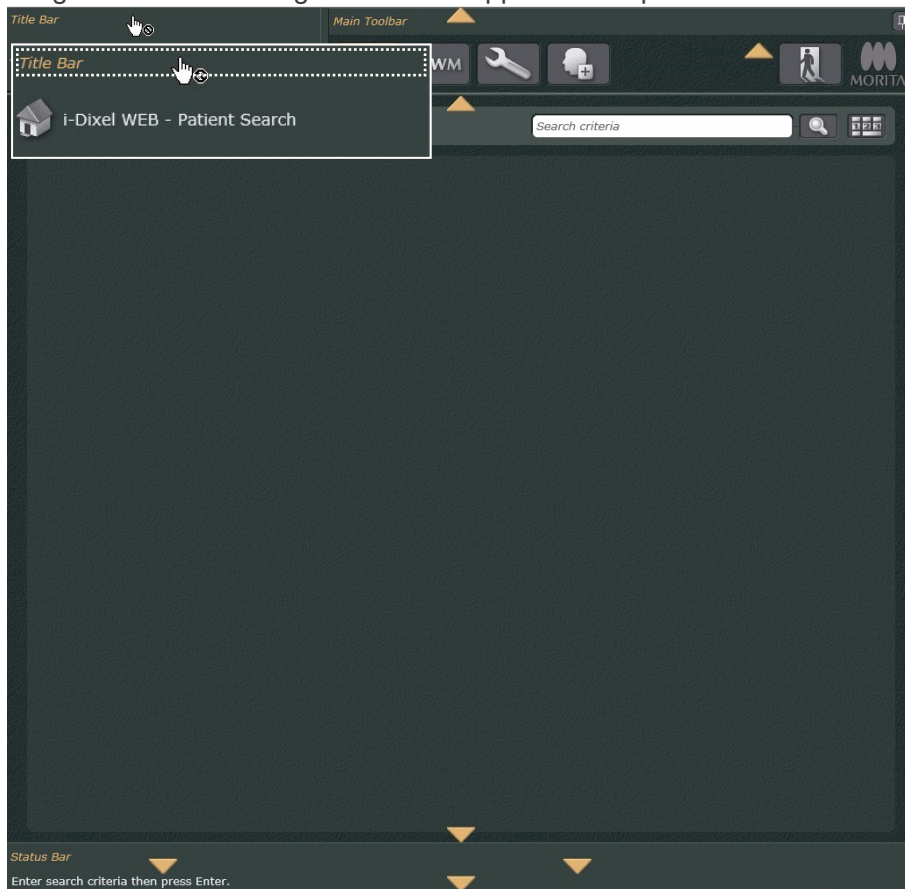



Drag the title bar onto the triangle mark where you want to place it.

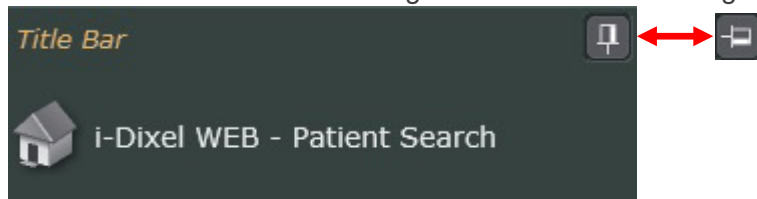

3. You can change how to display the title bar on the home page and main page. Click the Pinned button on the right of the title bar to change the setting.



Select “” to always show the title bar on both pages.

Select “” to unpin the title bar so that you can hide it when needed.

4. Right-click the title bar, and then click “Lock Toolbars” to make a selection.

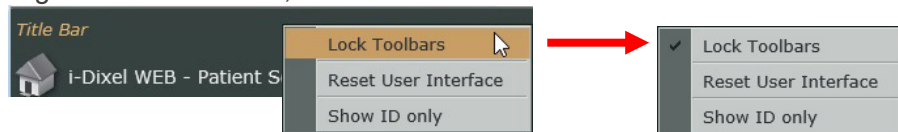

Example: How to change the layout of the image comparison panel.

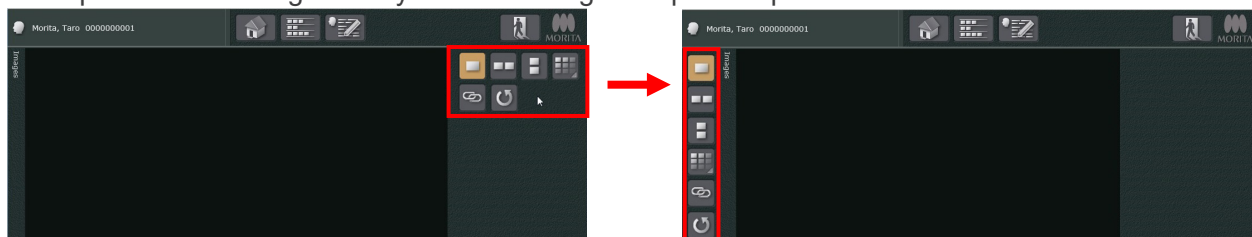

1. Right-click the blank area of the image comparison panel, and then click “Lock Toolbars” to cancel selection.

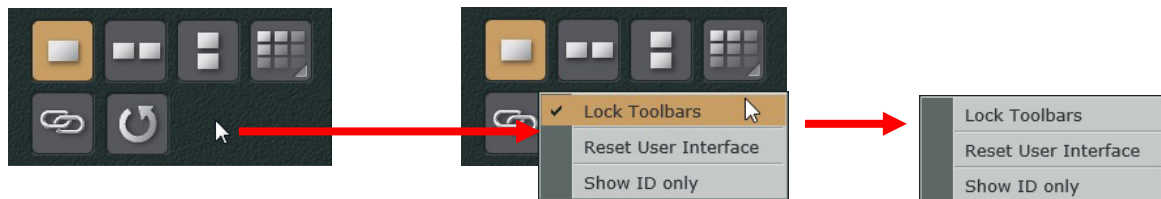

2. Drag the dotted area of the image comparison panel. Triangle marks will appear in the places where the image comparison can be set.

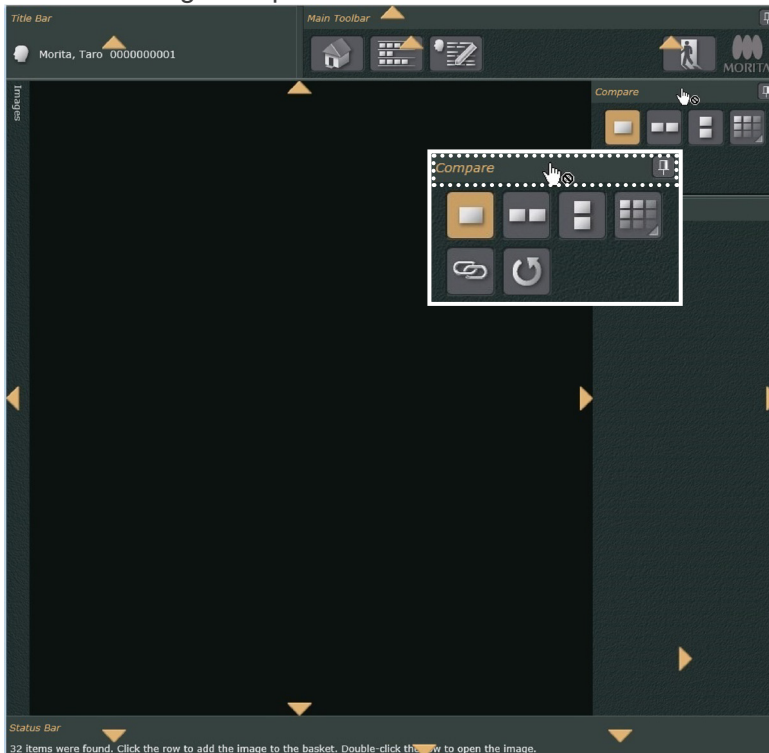

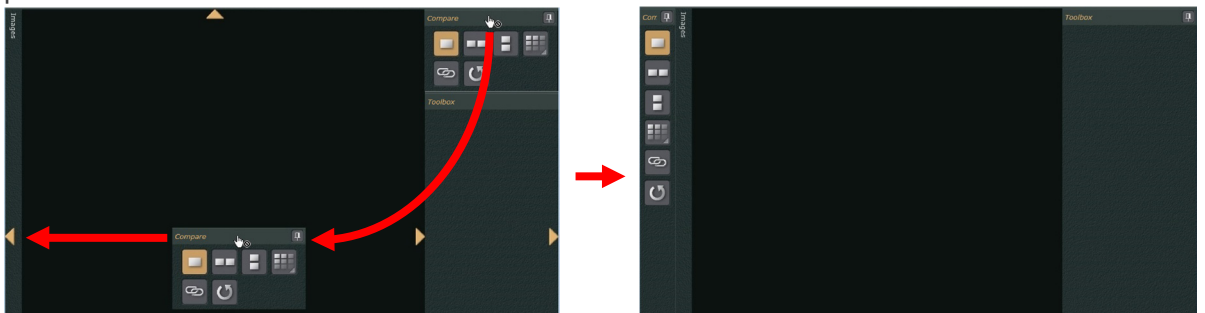

Drag the dotted area of the image comparison panel onto the triangle mark where you want to place.



3. You can change how to display the image comparison panel on the home page and main page. Click the Pinned button on the right of the image comparison panel to change the setting.



Select “” to pin down the image comparison panel to the pages.

Select “” to unpin the title bar so that you can hide it when needed.

- Right-click the blank area of the image comparison panel, and then click “Lock Toolbars” to make a selection.



Supplemental Remarks to Changing Layout Positions

- Changing layout of the title bar, main toolbar, and status bar.
Layout position of these bars can be changed for the home page and main page.
When you change the layout on the home page, it is reflected on the main page and vice-versa.
- Changing the image comparison panel and toolbox position.
These layout positions can be changed only for the main page.
- Shortcut menu
Cancel the selection of “Lock Toolbars” in the shortcut menu to change the layout position.
To fix the layout position, select “Lock Toolbars”.
Click “Reset User Interface” to reset the layout position.
- If you pin the title bar, main toolbar, or status bar:
Each bar will always be displayed on the home page and main page until you logout from the i-Dixel WEB.
- If you pin the image comparison panel or toolbox:
Each field or box will be displayed until the main page is closed.
- If you unpin the title bar, main tool bar, or status bar:
Each bar can be hidden from both the home and the main page until you logout from the i-Dixel WEB.
Each hidden bar can be displayed again, and after that they also can be re-hidden.

Example: Display hidden main toolbar, and then hide it again.

- Click the area where the main toolbar is hidden. The main tool bar will appear.

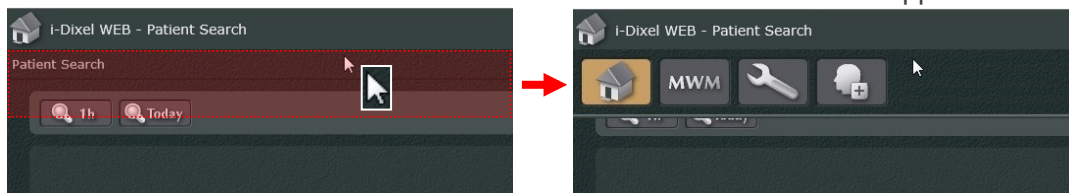

2) To hide the main toolbar again, click anywhere but the main toolbar.

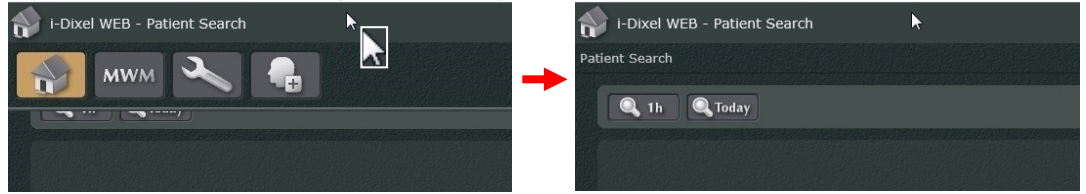

- If you unpin the image comparison panel:
The image comparison panel will be hidden until you close the main page.
Hidden image comparison panel or toolbox can be displayed again, and after that they also can be re-hidden.

Example: Display hidden image comparison panel, and then hide it again.

1) Click the compare bar. The image comparison panel will appear.



2) To hide the image comparison panel again, click anywhere but the image comparison panel.

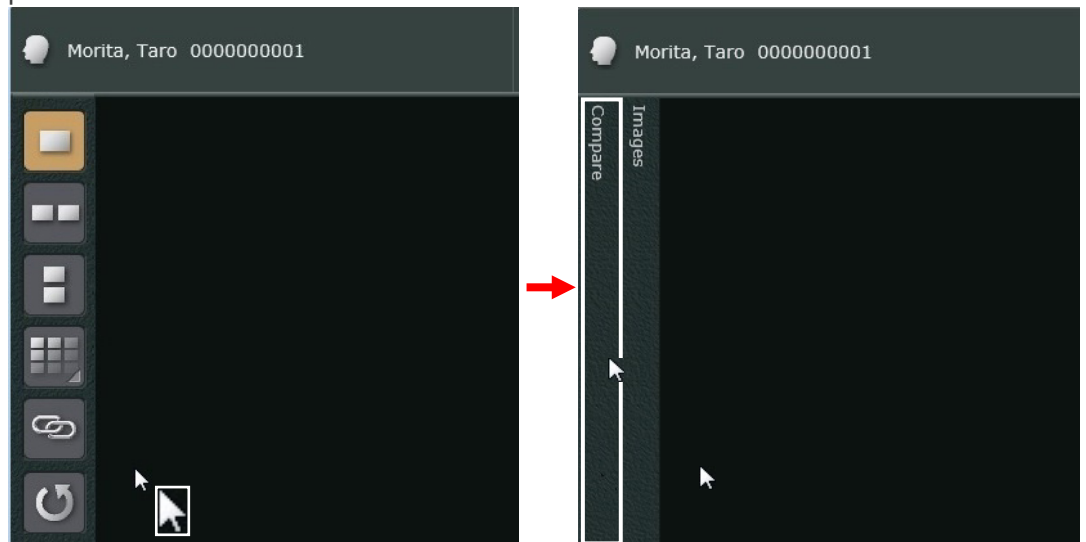

3. i-Dixel WEB Login and Logout

3.1. Login

1. Start up the web browser and enter the server address in the browser's address field.
2. After the address is entered, the Web browser displays the window below.
Enter your ID and Password to complete logging in.
Note that you can also enter the ID and Password using the keypad in the window.

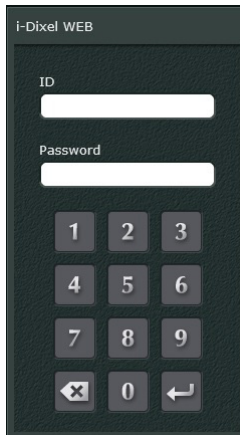

ID: Enter the ID registered on the i-Dixel server computer.
Password: Enter your password.

CAUTION

- *i-Dixel WEB cannot register user ID and password. These must be registered on the i-Dixel server using the i-Dixel application.*
- *We urge users to register and manage IDs and passwords appropriately and carefully to avoid leaking any patient information or images.*

3. After logging in, the Home Page for the i-Dixel WEB application will appear.

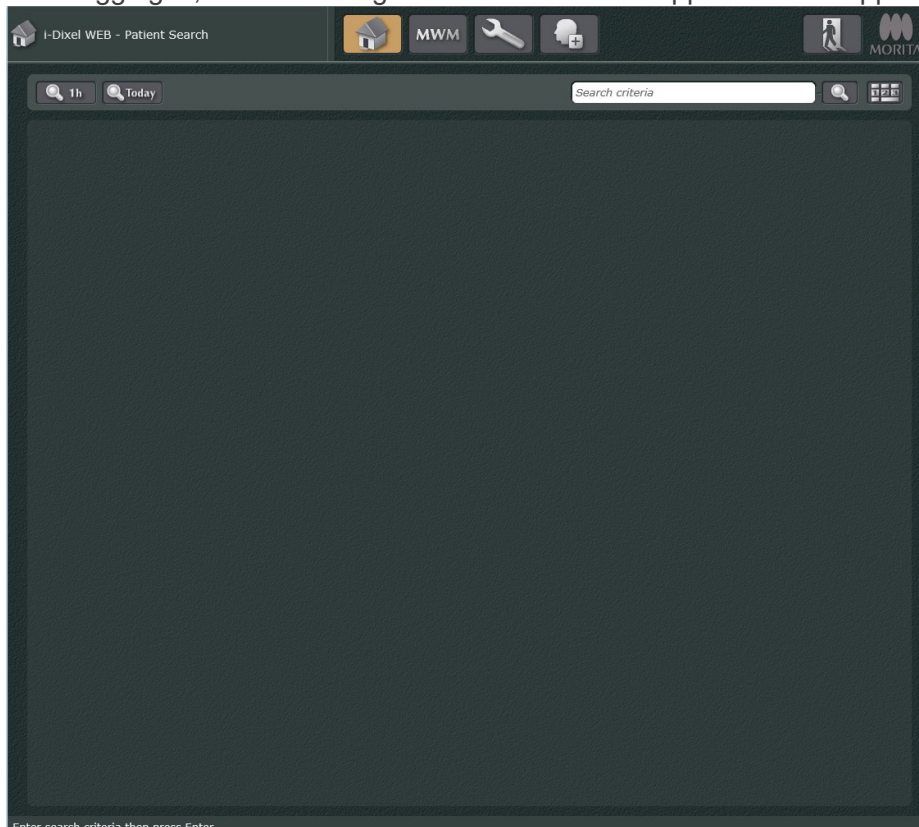

3.2. Logout

Logout in any one of the following ways.

1. Click this button () on the Home Page or the navigation bar. The display will return to the Login page.
2. Close the browser page or tab that is displaying the i-Dixel WEB page.
3. Click the Refresh button for the Web browser.
4. Go to any web page other than the one for the i-Dixel WEB.

Remarks for logging out except the way explained by the above 1.



- It may take some time for the logout procedure to be completed.
- If you logout in any way other than those noted above after executing “Open in a new window / tab or Show XYZ Show in a new window / tab” “2.2.1. 2D Viewer” (p. 16), the next time you login the screen being displayed just before logging out may appear instead of the Home Page. To prevent leaking an image, we recommend that you logout in one of the ways noted above so that the Home Page appears the next time you login.

4. Patient Registration

Registering new patients:

CAUTION

- *Using the Back button on the web browser to return to the Home page may bring up some other display.*

1. On the Home page, click the New Patient button ().
2. The dialogue box below appears.
Enter the required information and then click the Register button ()
"ID", "Name" and "Sex" are required items.

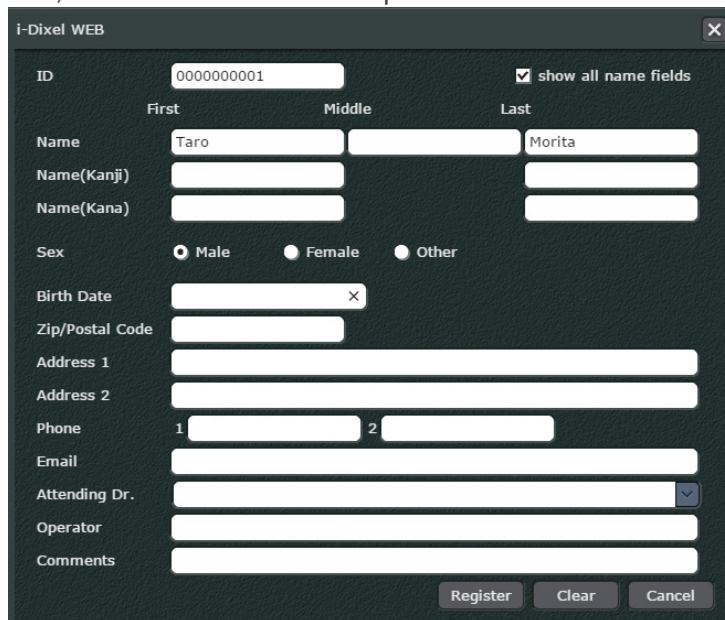



The screenshot shows a web browser window titled "I-Dixel WEB" with a close button in the top right corner. The form contains the following fields and options:

- ID:** A text input field containing "0000000001".
- show all name fields:** A checked checkbox.
- Name:** Three text input fields labeled "First" (containing "Taro"), "Middle", and "Last" (containing "Morita").
- Name(Kanji):** A text input field.
- Name(Kana):** A text input field.
- Sex:** Three radio button options: "Male" (selected), "Female", and "Other".
- Birth Date:** A date picker field.
- Zip/Postal Code:** A text input field.
- Address 1:** A text input field.
- Address 2:** A text input field.
- Phone:** Two text input fields labeled "1" and "2".
- Email:** A text input field.
- Attending Dr.:** A dropdown menu.
- Operator:** A text input field.
- Comments:** A text input field.

At the bottom of the form are three buttons: "Register", "Clear", and "Cancel".

5. Edit Patient Information

The information for a registered patient may be edited.

1. Display the patient list on the Home page.
Or search for the patient on the Home page.
See “6. Patient Search” (p. 30), for how to display the patient list and search for patients.
2. If the patient list is displayed, select the patient to be edited from it.
See “7. Image Selection” (p. 34), step 1 for how to select a patient.
3. The Main page will appear.
Click the Edit button () on the main tool bar.
4. The dialogue box below appears.
Enter the new information and then click the Register button ().
However, the “ID” cannot be changed.

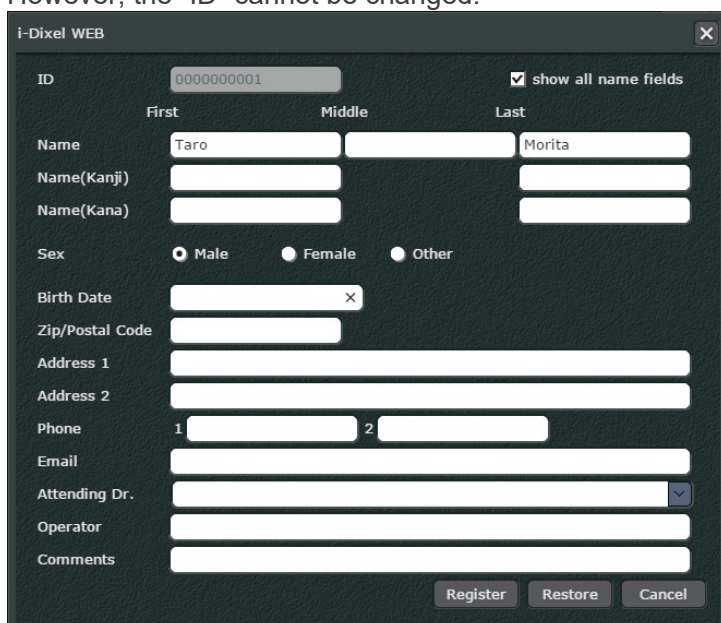

The screenshot shows a dialog box titled "i-Dixel WEB" with a close button (X) in the top right corner. The dialog contains the following fields and controls:

- ID:** A text field containing "0000000001". To its right is a checked checkbox labeled "show all name fields".
- Name:** Three text fields labeled "First", "Middle", and "Last". The "First" field contains "Taro" and the "Last" field contains "Morita".
- Name(Kanji):** A text field.
- Name(Kana):** A text field.
- Sex:** Three radio buttons labeled "Male", "Female", and "Other". "Male" is selected.
- Birth Date:** A date picker field.
- Zip/Postal Code:** A text field.
- Address 1:** A text field.
- Address 2:** A text field.
- Phone:** Two text fields labeled "1" and "2".
- Email:** A text field.
- Attending Dr.:** A dropdown menu.
- Operator:** A text field.
- Comments:** A text area.

At the bottom right of the dialog are three buttons: "Register", "Restore", and "Cancel".

6. Patient Search

6.1. Simple Search for Patient Information

Search for patients in the following way. A list of patients found will appear on the Home Page.

1. You can search for patients in any of the following four ways.

- Enter patient information parameters in the search field and then click this button () at the right side of the field.

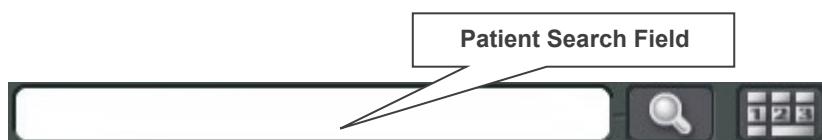



Enter the patient's whole name or ID number.

You can also enter just part of the name or ID number.





- * Patient ID can be input by keypad on the display.

Click the button () to display the keypad.

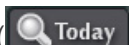
- You can also simply click the button () without entering any information at all. The maximum number of search result is 500 names.
 - * When the list of patient is displayed on the last, in the order in which patients are listed, it is searched.
 - * The maximum number of search result is 50 names for the iPad.

- You can click this button (). This will bring up a list of all the updates made in the last hour.

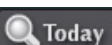
- You can click this button (). This will bring up a list of all the updates made on the current date.

- * If you enter patient information in the search field, do not forget to click this button (). These buttons (, ) have priority over this button ()

2. A list of patients corresponding to the search parameters will appear.

Patient ID	Name	Sex	Date of Birth	Age	Reg. Date	Modified D...	Images	Comments
0000000001	Morita, Taro	M			9/17/2013	9/24/2013	23	
0000000002	Morita, Hanako	F			9/17/2013	10/8/2013	2888	
0000000003	Morita, Ziro	M			9/17/2013	9/24/2013	8	

- * If only one patient is found by the search, the image list for that patient will appear immediately.
- * The format of the patient names displayed in the search results follows the setting in the "Name sort order" dialog of i-Dixel explained in "Title Bar:" (p. 6) of "2.2. Main Page".

You can change the order of the patient list as explained on "Change Order of Patient List" (p. 31).

Also, you can select which parameter will be shown on the list as explained in "Change Display Parameters" (p. 31).

Change Order of Patient List

Click on one of the categories to use it to order the list; click it again to reverse the current top-to-bottom order.

Any of the categories can be used to order the list.

For example, click Patient ID to use it to order the list; click it again to reverse the current top-to-bottom order.

The diagram illustrates the process of sorting a patient list. It shows two screenshots of a patient list table. In the first screenshot, the 'Patient ID' column is highlighted with a red box, and a callout box says 'Click Patient ID'. The list is ordered by Patient ID from top to bottom. A second callout box says 'List ordered by Patient ID'. A red arrow points down to the second screenshot, where the 'Patient ID' column is again highlighted, and a callout box says 'Click Patient ID'. The list is now reversed, with Patient ID 0000000005 at the top and 0000000001 at the bottom. A callout box says 'Order is reversed'. A red arrow points up from the second screenshot to the first, indicating the reverse action.

Patient ID	Name	Sex	Date of Birth	Age	Reg. Date	Modified D...	Images	Comments
0000000001	Morita, Taro	M			9/17/2013	12/6/2013	25	
0000000002	Morita, Hanako	F			9/17/2013	12/3/2013	2895	
0000000003	Morita, Ziro	M			9/17/2013	11/22/2013	9	
0000000004	Morita, Momoko	F			9/25/2013	12/6/2013	2	
0000000005	Morita, Goro	M			10/2/2013	12/6/2013	734	

Patient ID	Name	Sex	Date of Birth	Age	Reg. Date	Modified D...	Images	Comments
0000000005	Morita, Goro	M			10/2/2013	12/6/2013	734	
0000000004	Morita, Momoko	F			9/25/2013	12/6/2013	2	
0000000003	Morita, Ziro	M			9/17/2013	11/22/2013	9	
0000000002	Morita, Hanako	F			9/17/2013	12/3/2013	2895	
0000000001	Morita, Taro	M			9/17/2013	12/6/2013	25	

Change Display Parameters

Right-click the parameter area, and then make or clear the selection to be displayed.

Make a selection to show the parameter in the patient list, and clear the selection to omit it from the patient list.

The screenshot shows a patient list with a context menu open over the parameter area. The menu items are: Patient ID (checked), Name (checked), Sex (checked), Date of Birth (checked), Age (checked), Reg. Date (checked), Modified Date (unchecked), Images (checked), and Comments (checked). The patient list shows the first three rows: Patient ID 0000000001, Name Morita, Taro, Sex M; Patient ID 0000000002, Name Morita, Hanako, Sex F; Patient ID 0000000003, Name Morita, Ziro, Sex M.

Patient ID	Name	Sex
0000000001	Morita, Taro	M
0000000002	Morita, Hanako	F
0000000003	Morita, Ziro	M

* The "Patinet ID" is always displayed in the patient list. It is not possible to unselect this parameter.

* When unselecting a parameter, it will be omitted from the shortcut menu. It will be reflected after you close the i-Dixel WEB or search for a patient.

If you prefer to show the parameter again, it is necessary to change the setting. For details, see "15.2. Workstation" (p. 208).

6.2. Detailed Search for Patient Information

Click the Detailed Patient Search Display button () to display the Detailed Patient Search page.

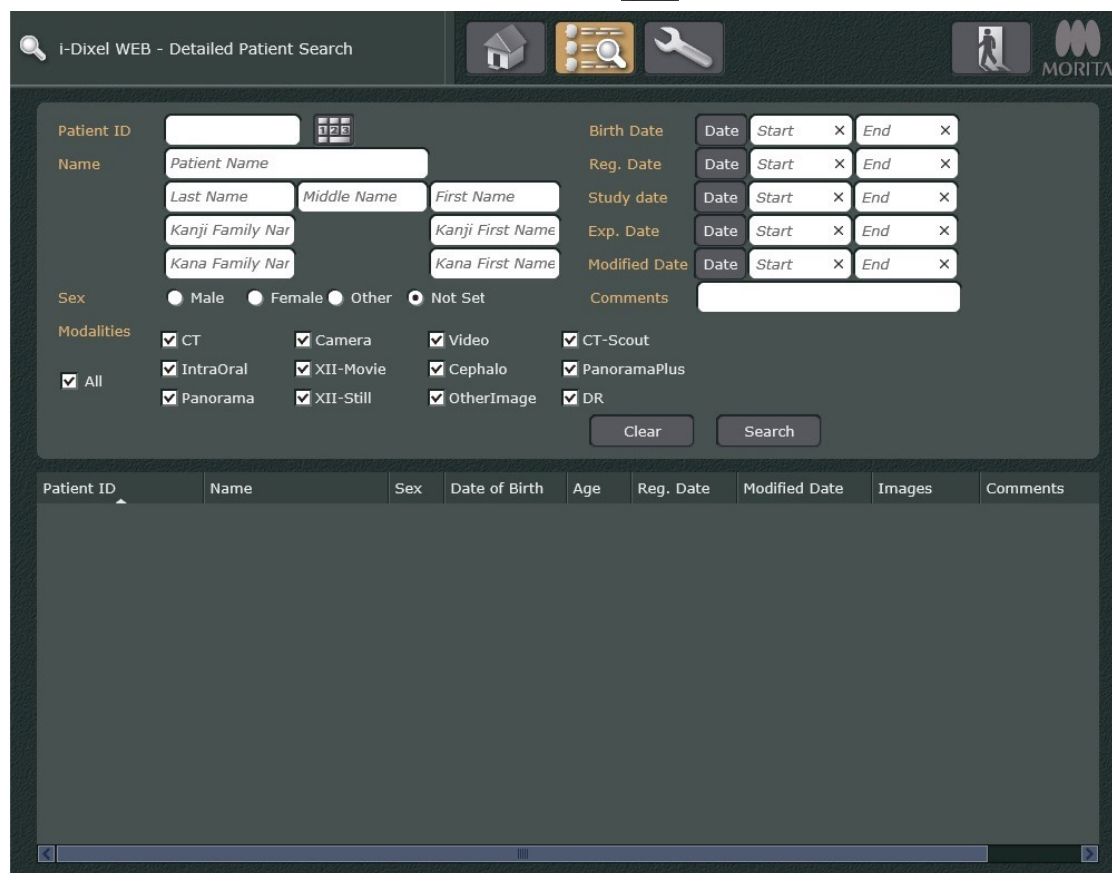

The screenshot shows the 'I-Dixel WEB - Detailed Patient Search' interface. It features a search form with the following fields and options:

- Patient ID:** A text input field.
- Name:** Fields for Patient Name, Last Name, Middle Name, First Name, Kanji Family Name, Kanji First Name, Kana Family Name, and Kana First Name.
- Birth Date:** A date range selector with 'Date', 'Start', 'End', and 'x' buttons.
- Reg. Date:** A date range selector.
- Study date:** A date range selector.
- Exp. Date:** A date range selector.
- Modified Date:** A date range selector.
- Sex:** Radio buttons for Male, Female, Other, and Not Set.
- Comments:** A text input field.
- Modalities:** A grid of checkboxes for CT, Camera, Video, CT-Scout, IntraOral, XII-Movie, Cephalo, PanoramaPlus, All, Panorama, XII-Still, OtherImage, and DR.
- Buttons:** 'Clear' and 'Search' buttons.

Below the form is a table with the following columns: Patient ID, Name, Sex, Date of Birth, Age, Reg. Date, Modified Date, Images, and Comments. The table is currently empty.

You can search any combination of “Patient ID”, “Name”, “Birth Date” (of the patient), “Reg. Date” (date of the first registration of the patient), “Study Date” (date of specifying the image to be saved), “Exp. Date” (date of capturing the image), “Modified Date” (date of updating the image), “Sex” (of the patient), “Comments”, and “Modalities” (classification attributes to save the image).

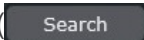
Setting the search conditions and clicking the “Search” button () displays the results of the search.

If you select “All” when searching with the “Modalities” key, all modalities will be included in the search conditions.

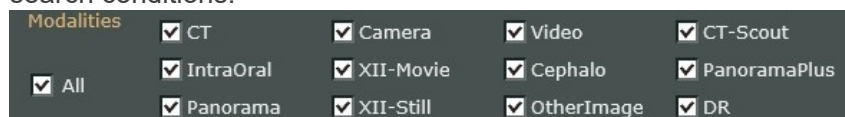

The screenshot shows the 'Modalities' section of the search interface. It contains a grid of checkboxes for the following modalities:

- CT
- Camera
- Video
- CT-Scout
- IntraOral
- XII-Movie
- Cephalo
- PanoramaPlus
- All (checked)
- Panorama
- XII-Still
- OtherImage
- DR

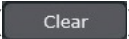
Click the “Clear” button () to delete the set search conditions and the results of the search.

Note that the format of the patient names displayed in the search results follows the setting in the “Name sort order” dialog of i-Dixel explained in “Title Bar:” (p. 6) of “2.2. Main Page”.

Example: Searching the patient named Ichiro Morita using his last name and sex

1. Enter "Morita" in the "Name" textbox. Select "Male" in the "Sex" field, and click the "Search" button.

The screenshot shows a patient search interface. The 'Name' field is filled with 'Morita'. Below it, there are sub-fields for 'Last Name', 'Middle Name', and 'First Name'. The 'Sex' field has radio buttons for 'Male', 'Female', 'Other', and 'Not Set', with 'Male' selected. To the right, there are date pickers for 'Birth Date', 'Reg. Date', 'Study date', 'Exp. Date', and 'Modified Date'. At the bottom, there are 'Clear' and 'Search' buttons. The 'Search' button is highlighted with a red box.

2. A list of search results will be displayed. Double-click the patient to display the Main Page for the patient.

Patient ID	Name	Sex	Date of Birth	Age	Reg. Date	Modified Date	Images	Comments
0000000001	Ichiro Morita	M	1/1/1980	42	8/27/2011	4/25/2022	1118	
0000000003	Saburo Morita	M	2/2/1990	32	8/27/2011	11/12/2021	8	
0000000005	Goro Morita	M	3/3/2000	22	8/31/2011	11/12/2021	1912	
0000000010	Ichiro Morita	M	1/1/1980	42	10/26/2011	5/21/2015	443	

It is possible to right-click the patient to bring up the "Open", "Open in New Window/Tab" pop-up menu to display the Main Page for the patient.

Patient ID	Name	Sex	Date of Birth	Age	Reg. Date	Modified Date	Images	Comments
0000000001	Ichiro Morita	M	1/1/1980	42	8/27/2011	4/25/2022	1118	
0000000003	Saburo Morita	M	2/2/1990	32	8/27/2011	11/12/2021	8	
0000000005	Goro Morita	M	3/3/2000	22	8/31/2011	11/12/2021	1912	
0000000010	Ichiro Morita	M	1/1/1980	42	10/26/2011	5/21/2015	443	

7. Image Selection

Select a patient on the Home page; then the Main page will appear.
Select an image

* In this manual, CT image refers to both volume rendered images and the CT slices linked to them.

⚠ CAUTION

- **Clicking the “Back” button on the Web browser while an image is displayed, will not always return to the previous display.**

1. Select a patient by double-clicking.

Patient ID	Name	Sex	Date of Birth	Age	Reg. Date	Modified D...	Images	Comments
000000001	Morita, Taro	M			9/17/2013	9/24/2013	23	
000000002	Morita, Hanako	F			9/17/2013	10/8/2013	2888	
000000003	Morita, Ziro	M			9/17/2013	9/24/2013	8	

It is also possible to right-click the patient to bring up the “Open”, “Open in New Window/Tab” pop-up menu and select the patient.

Patient ID	Name	Sex	Date of Birth	Age	Reg. Date	Modified D...	Images	Comments
000000001	Morita, Taro	M			9/17/2013	12/6/2013	24	
000000002	Morita, Hanako				9/17/2013	12/6/2013	2896	
000000003	Morita, Ziro				9/17/2013	11/22/2013	9	

* If “Open in New Window/Tab” is selected, new tab will appear on the Web browser and it will display the Main page.
However for some tablet computers like the iPad, the “Open in New Window/Tab” option will not appear.

2. Select an image from the list.
Select in the following ways

- 2D Images See “2.2.1. 2D Viewer” (p. 16).
- CT Slice Images See “2.2.1. 2D Viewer” (p. 16).
- CT Images See “2.2.2. 3D Viewer” (p. 19).

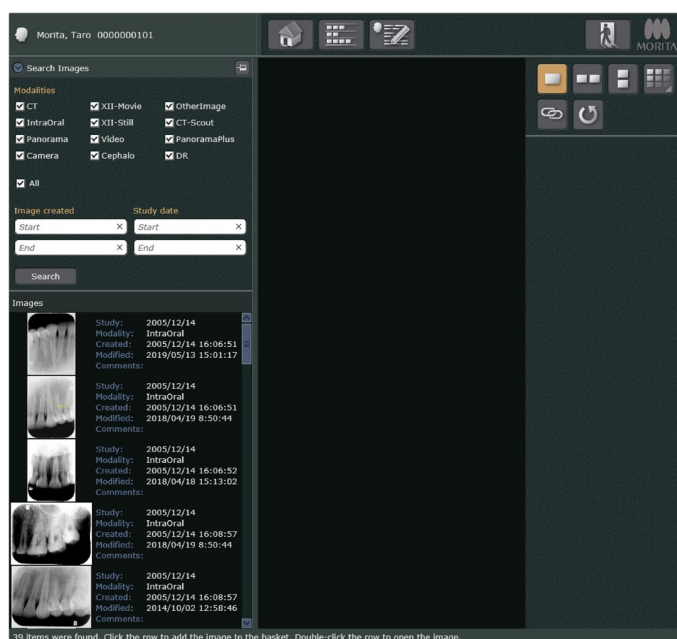

* If necessary, the list may be rearranged to search for an image. The style of the list may also be changed. See “2.2. Main Page” (p. 5).

* You can add up to 500 images to the “image list.” If the number of images exceeds 500, you will be required to refine the “image list” by searching and filtering out the images to be included in the “image list.”

3. Image Displays.

Displays differ depending on the type of image.

- 2D Image



- CT Slice Image

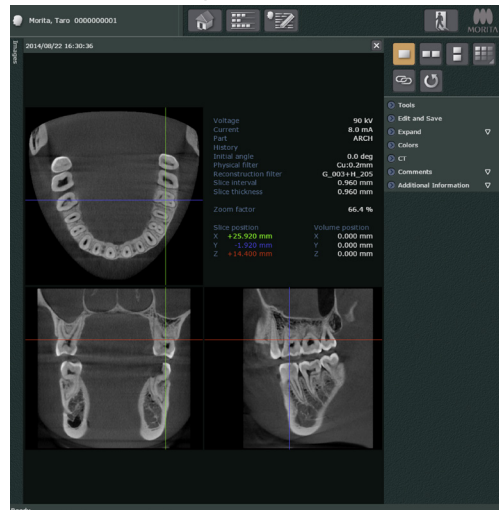

- CT Image

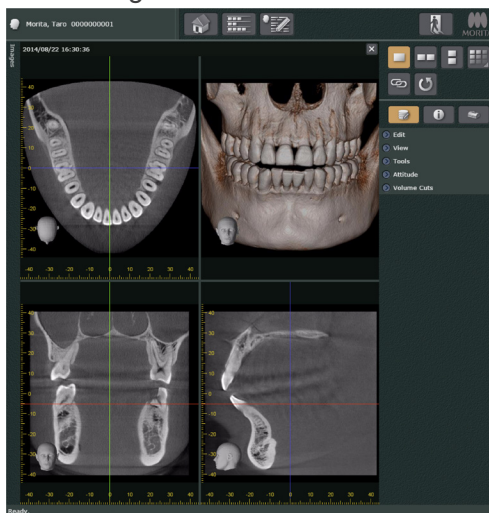

2D images and CT slice images are displayed in the 2D viewer. However, the editing tools available are not the same.

For 2D image editing tools, see “10. Edit 2D Images” (p. 56).

For CT slice image editing tools, see “11. Edit CT Slice Images” (p. 103).

CT images are displayed in the 3D Viewer.

For CT image editing tools see “12. Edit CT Images” (p. 118).

Multiple Images Selected

When multiple 2D images or CT slices are selected for display in the 2D viewer, their thumbnails will appear in a basket in the upper right part of the display. Click a thumbnail to display the image.

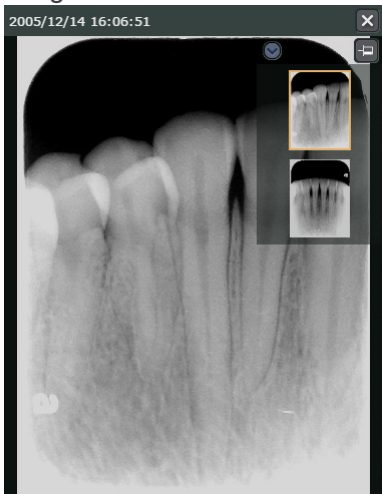

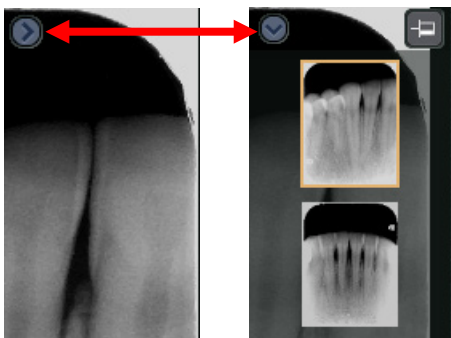

Click the Arrow button () to hide or display the basket.

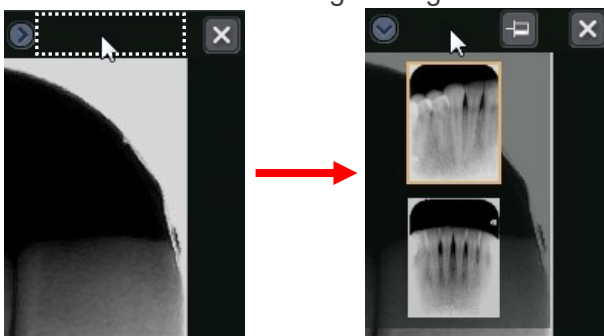

If the button in the right side is unpinned (), clicking anywhere other than the basket will hide the thumbnail image list. Click the area inside the dotted frame as shown in the illustration below to show the thumbnail image list again.



If you click the Unpinned button () and change it to the Pinned button (), the thumbnail image list will always be displayed even if you click somewhere other than the basket.

However, multiple CT images cannot be selected.

8. Image Comparison Display

2D images and CT slice images can be compared in the 2D viewer.

Image with the 2D viewer and CT volume data with the 3D viewer (volume rendered images etc.) can be compared.

You can also compare and display up to two CT volume data simultaneously with the 3D viewer.

Comparison Display for Panorama and CT Slices

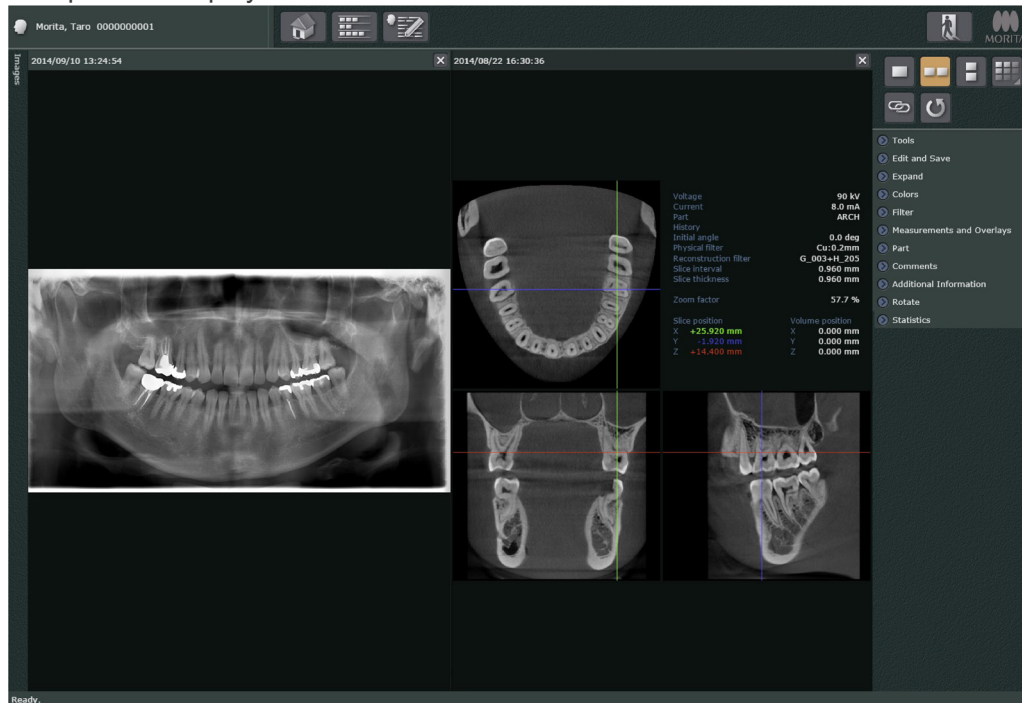

Comparison Display for Panorama, CT slice and Volume Rendered images

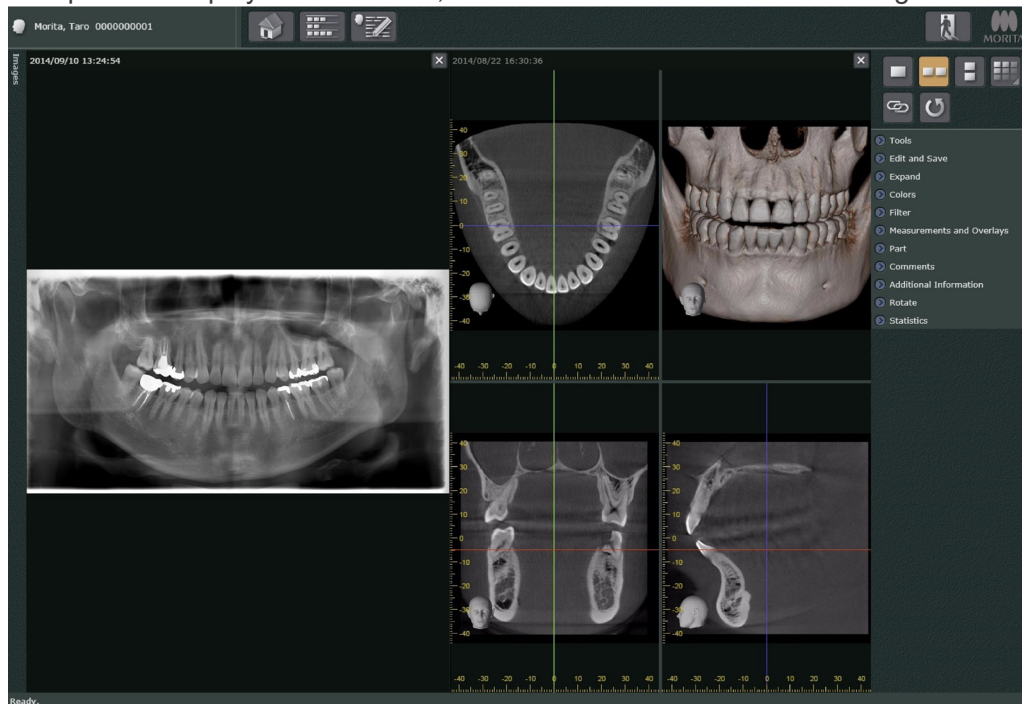

* Panorama images appear in the 2D viewer.

CT slice and volume rendered images appear in the 3D viewer.

Comparative display of two CT volume data simultaneously with the 3D viewer

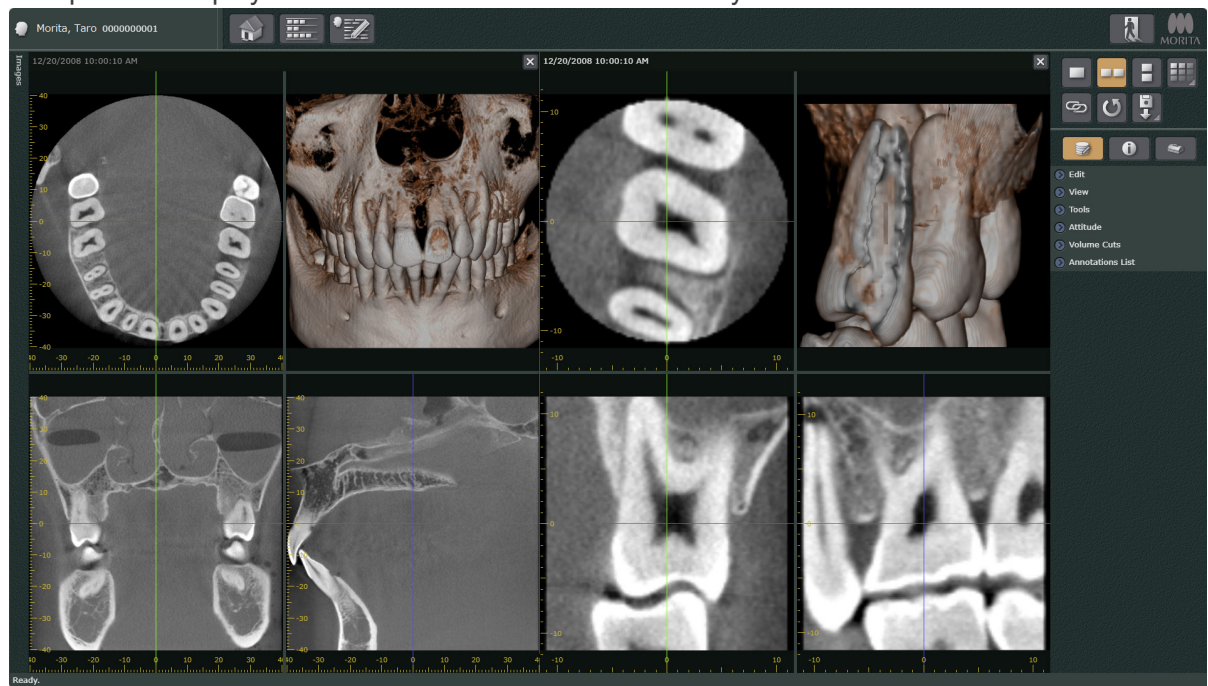

* CT slice images and the volume rendered images are displayed in the 3D viewer.

Compared images appear on the Main page.
Click one of the buttons to select an arrangement for the images.

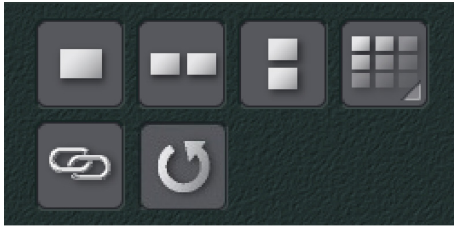

A single image is displayed.

If two or more images are being displayed, click this button to leave the image comparison display.



Two images are displayed side by side.



Two images are displayed, one above the other.



Multiple images display in specified arrangement.
For details see “Image Arrangements” (p. 41).

- For tablet terminals such as the iPad

For tablet terminals such as the iPad, the button for multiple images () is grayed out and cannot be used.



Click this Link button, to link the images for operations such as enlarging or shrinking them.
For details see “Linked Operations for All Comparison Images” (p. 50).

- For iPad Safari

If the images are linked by clicking the Link button () , adjusting the contrast or brightness for the images may cause Safari to suddenly shut down. If Safari suddenly shuts down, editing changes will be lost. Save editing changes, before adjusting the brightness or contrast.



Click this button to update the image currently displayed to the latest one.

This function is useful, for example, when the same image is displayed on your own terminal and another terminal, and you wish to immediately reflect an edit made to the image from the other terminal into your image.

Compare Images

How to compare two 2D images vertically.

1. Click the Vertical Arrangement button ().
2. Select a 2D image from the image list.
It will appear in the top position of the 2D viewer.

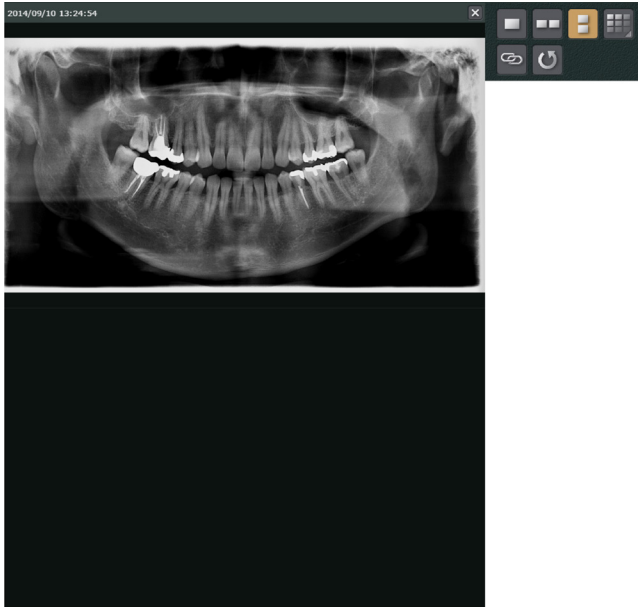

3. Select another 2D image from the image list.
It will appear in the bottom position of the 2D viewer.

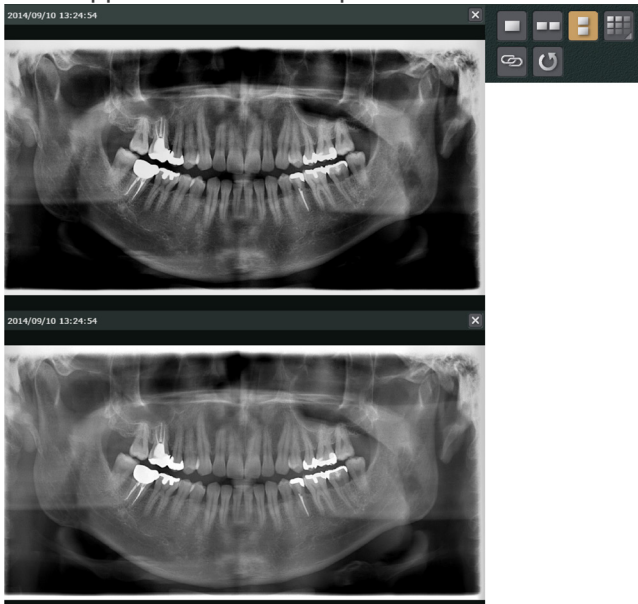

- * Click the Single Image button () to leave the comparison display.

Image Arrangements

How to display four 2D images in two rows and two columns

1. Click the Multiple Image button ().
A grid to select the arrangement will appear.
Use the pointer to select an arrangement of 2 rows and 2 columns

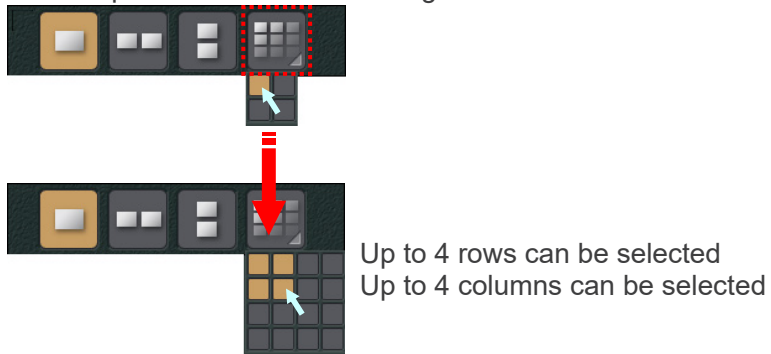

- For tablet terminal such as the iPad

For tablet terminals such as the iPad, the button for multiple images () is grayed out and cannot be used.

2. Image Selection
Order of image selection

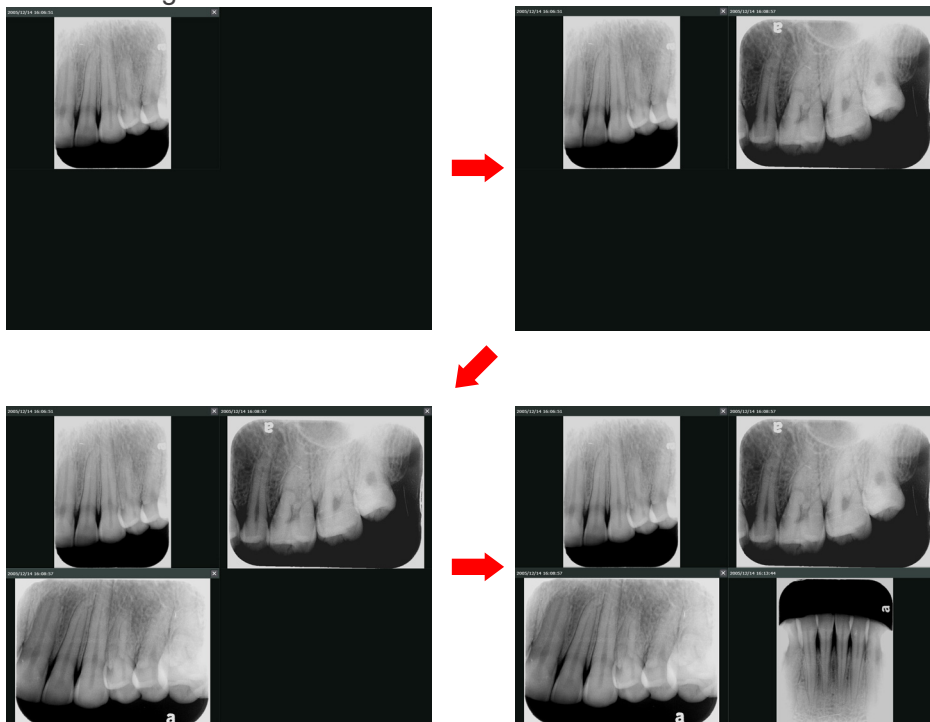

- * Select an image by clicking it or its title bar.
The titled bar for a selected image is highlighted.



- * Click the Single Image button () to leave the comparison display.
- * To compare 5 or more images, a basket for the images will appear in the lower right image area.
Click an image thumb nail to display it.



Rearrange Comparison Images

How to rearrange images arranged in 2 rows and 2 columns

Rearrange the upper left and lower right images.

1. Drag the upper left image by its title bar to the lower right.

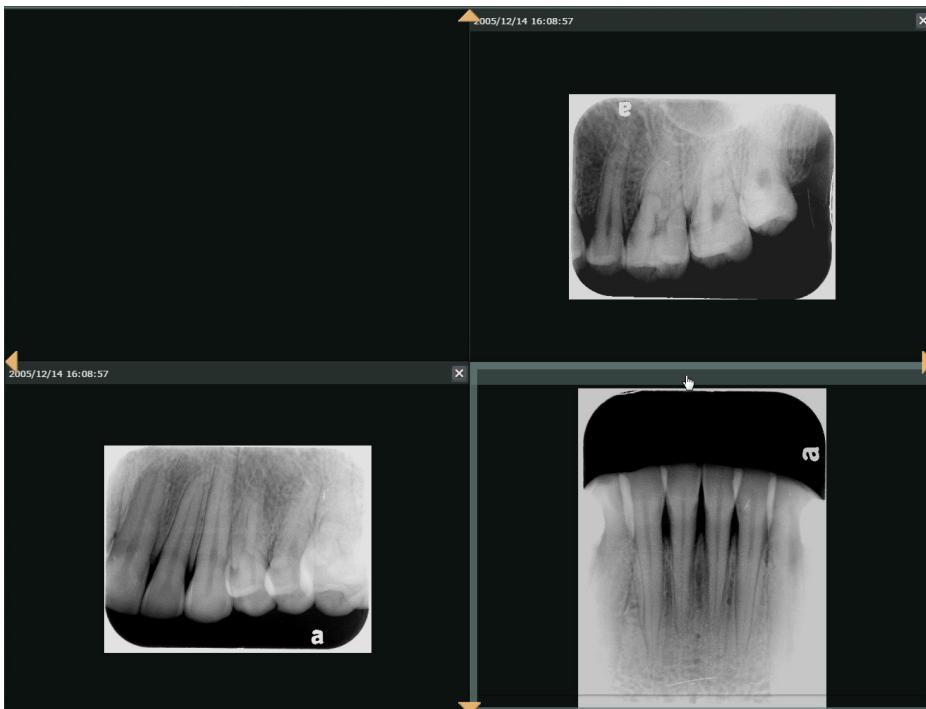
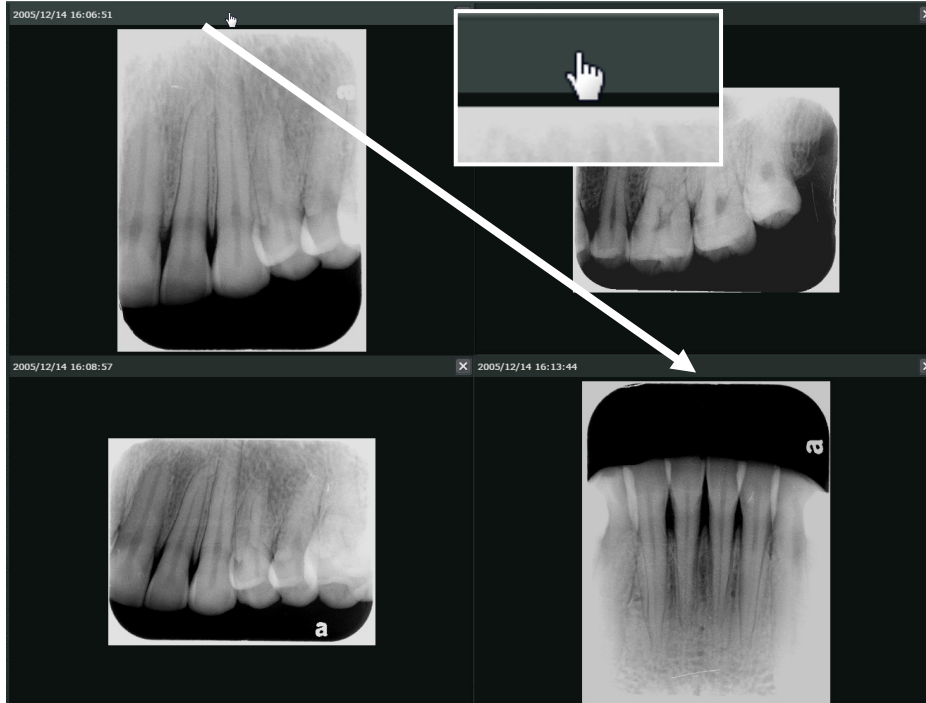

2. The image will replace the lower right image and the button to display the basket (🗑️) will appear.



Display the basket and select an image to put in the upper left spot.

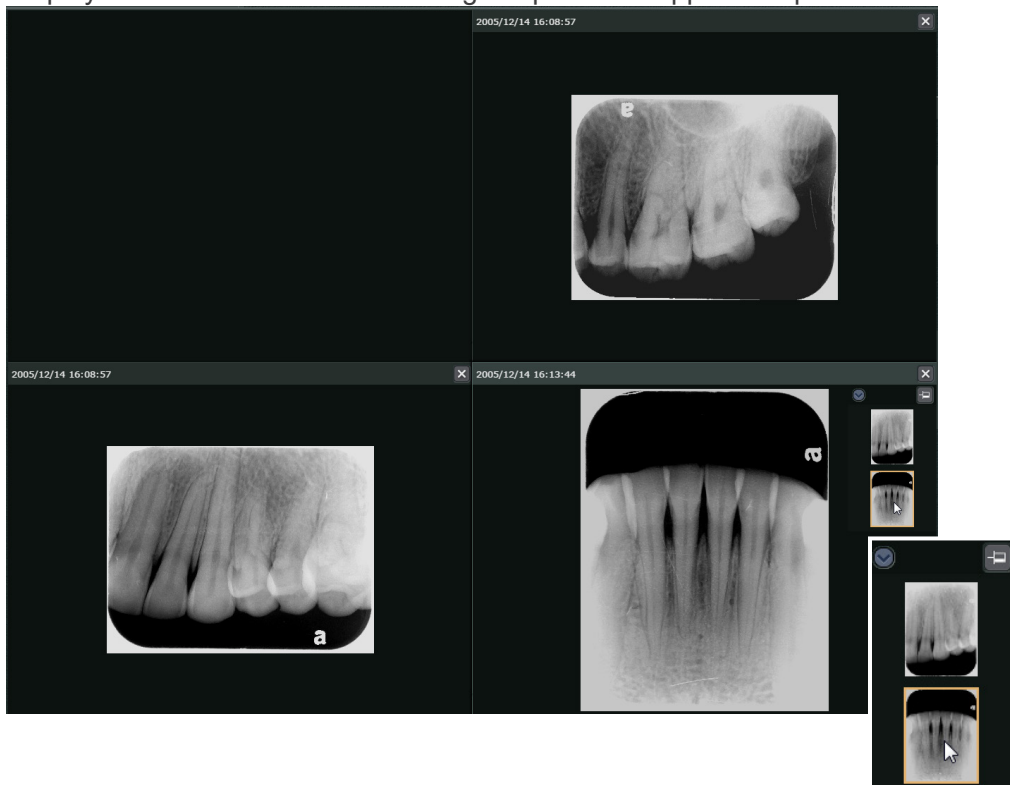

3. Drag the lower right image by its title bar to the upper left spot.

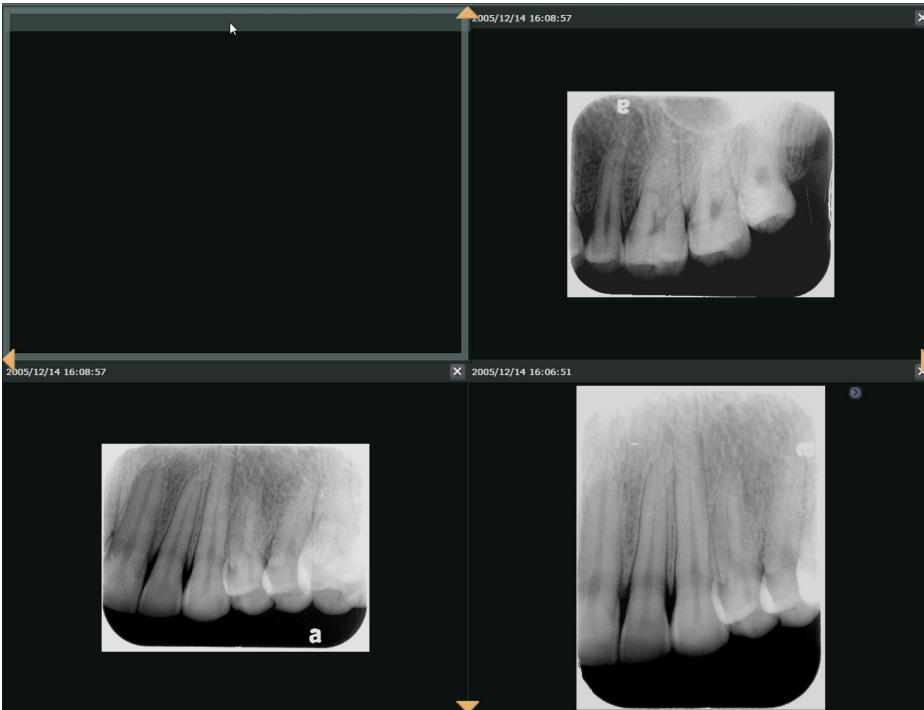

4. The upper left and lower right images will switch places.

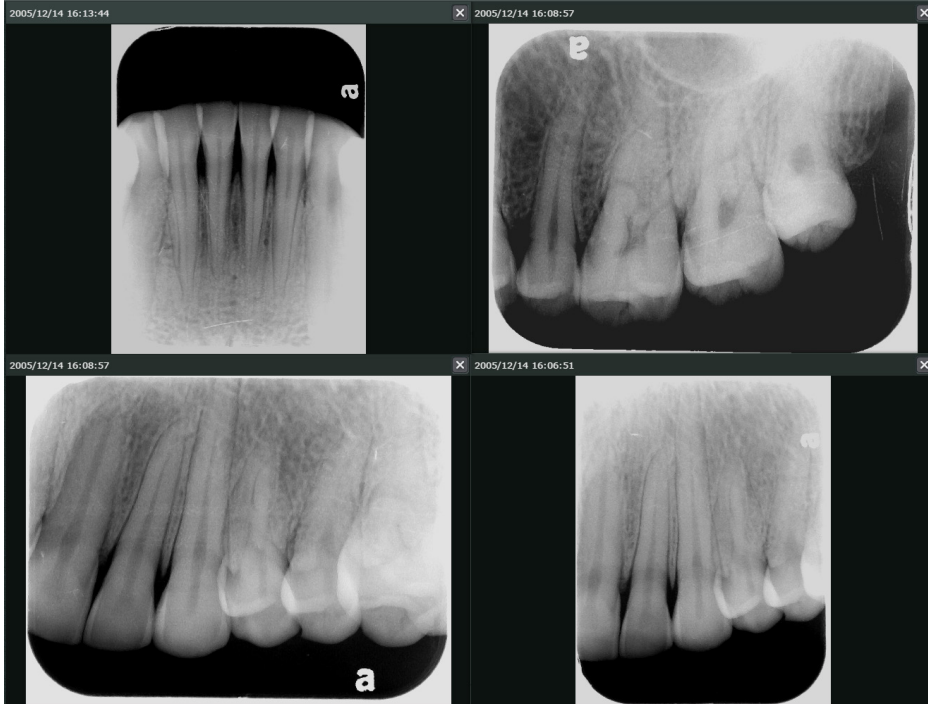

Separate display areas for comparative image displays

The display area can be divided into 2 parts with a single image in the center of the display. Separate images can be displayed in the divided display area. Or multiple images can be displayed in the separated area.

Display a panorama image and dental images in separate areas

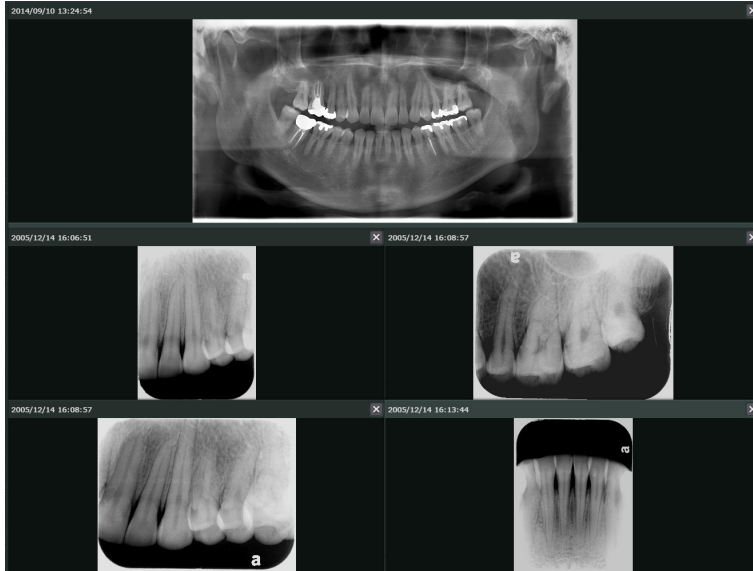

The display area is divided into 2 parts while the panorama image is being displayed, and dental images are displayed in the separated area. The arrangement of the dental images is the same as for comparative image displays.

1. Drag the panorama's title bar up.

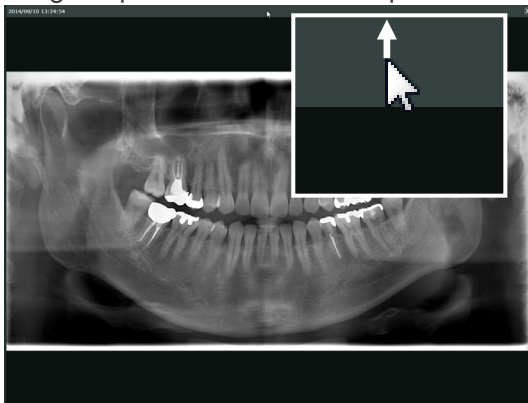

2. Triangles will appear in the display. Move the top triangle with the mouse.

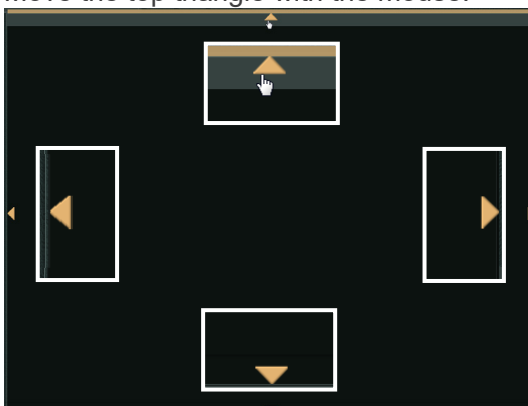

3. The display area will be divided into 2 parts with the panorama image at the top.

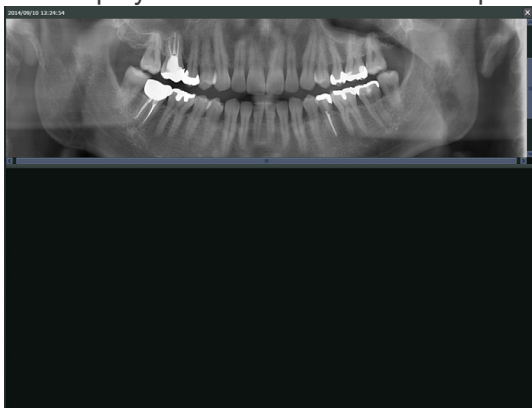

If necessary, the magnification and area for the panorama image can be adjusted.

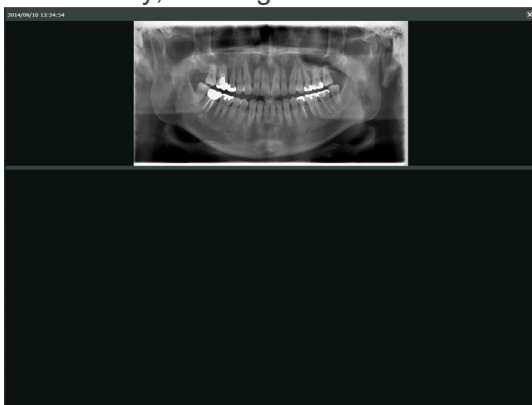

- * To adjust the magnification, see "10.3. Expand" (p. 64).
- * Drag the line separating the 2 areas to adjust its size.

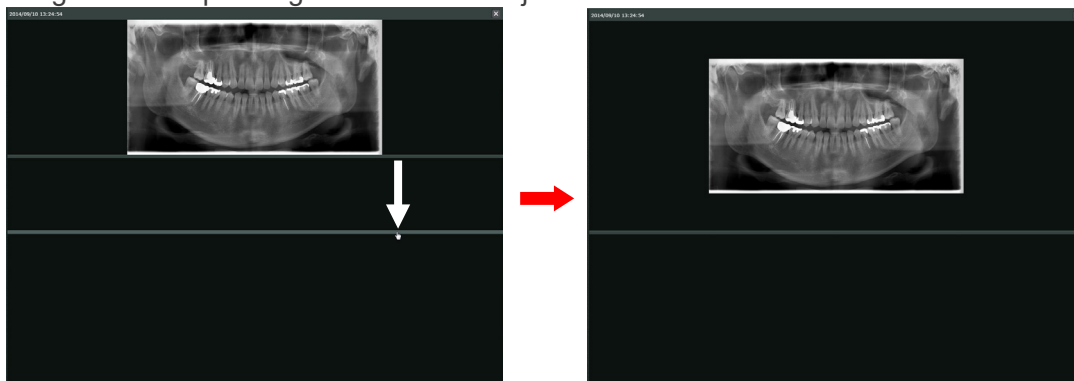

4. Click the Comparative Images button () to specify the arrangement. After specifying the arrangement, a grid will be displayed.

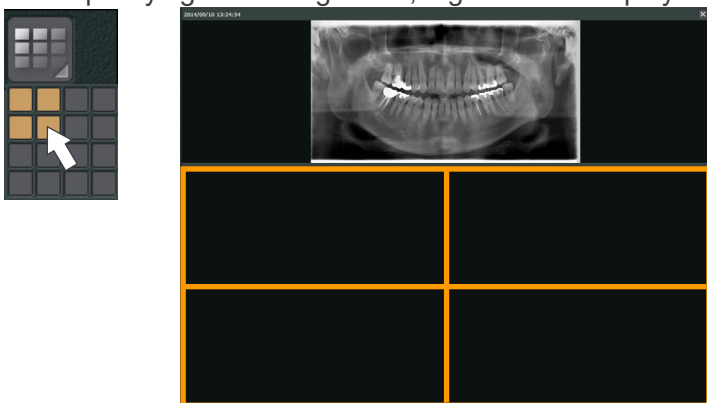

5. Arrange the dental images
For details see "Image Arrangements" (p. 41).

* Cancel the 2 separate display areas.

- 1) Set the display for 1 row and 1 column.



Or click the Single Image button (■).

- 2) Drag the image title bar down not to be overlapping the triangles and the mouse cursor.

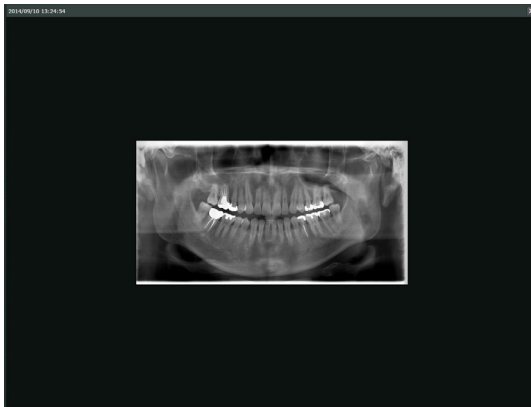
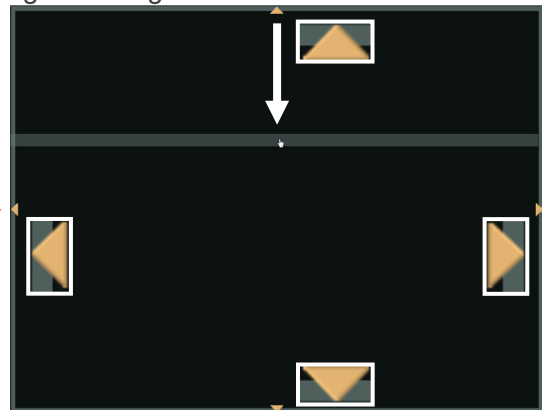
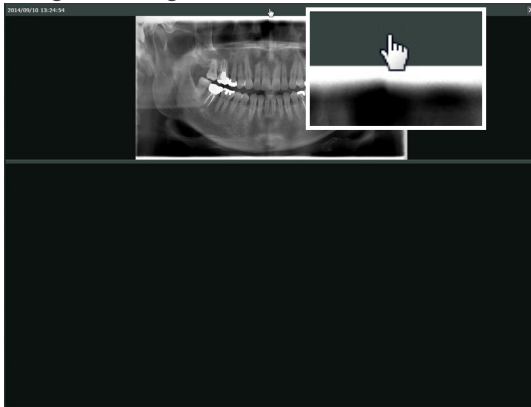



Linked Operations for All Comparison Images

The operations that can be performed simultaneously for all images being compared are listed below:

1. Zoom In and Out
2. Zoom Ratio
3. Fit Screen
4. Contrast Adjustment
5. Brightness Adjustment
6. Enlargement of part of an image

* For items 1, 2, 3 and 6 above, see “10.3. Expand” (p. 64).
For items 4 and 5 above, see “10.4. Colors” (p. 68).

Example: Simultaneously fit images with different magnification to the screen.

1. Click this button ()
2. See “10.3. Expand” (p. 64). Click this button ()



3. Both images simultaneously fit the whole screen.

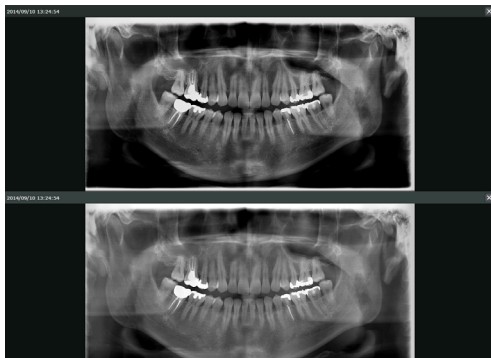
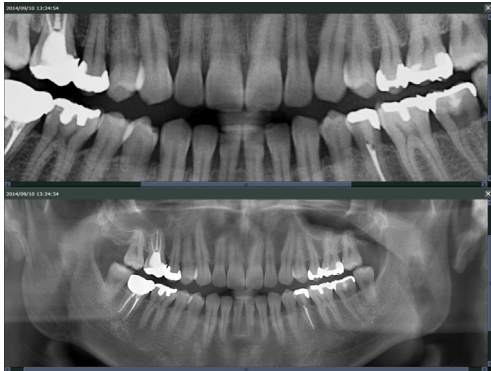

9. Import Images

2D images can be imported from a hard disk or other storage media for patients selected (or searched for) on the “Home Page.”

You can import the images by using the Import button () displayed in the comparison items on the Main Page.



Moreover, you can import 2D images from a TWAIN device.

[Importing from storage media]

1. Select (or search for) the patient for whom the images are to be imported on the Home Page and display the Main Page.

2. Click the Import button () and select “2D Import”.



3. The following dialog is displayed.

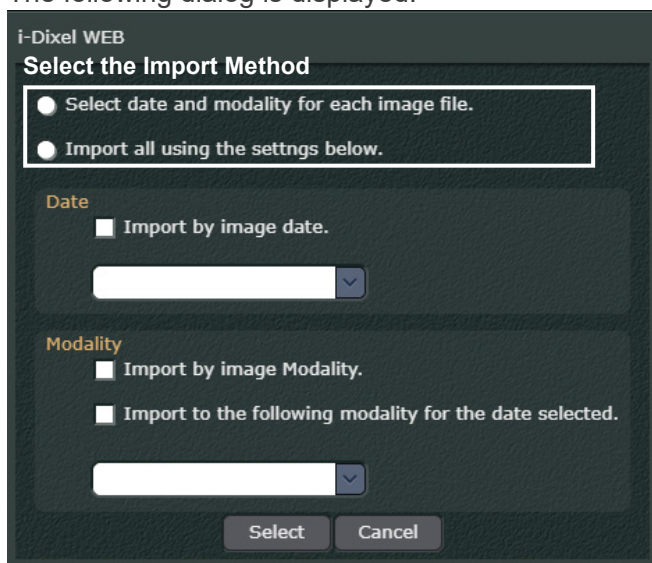

Select the import method

To import a single image or multiple images separately:

Select “Select date and modality for each image file”.

To import multiple images all at once:

Select “Import all using the settings below”.

“Date” Settings

When “Import all using the settings below” is selected, set the target date for import automatically or manually.

When setting to Automatic:

Select “Import by image date”.

When setting to Manual:

Select the date from pull-down menu. The pull-down menu shows the date of acquisition for images created for the currently selected patient and the current date.

“Modality” Settings

When “Import all using the settings below” is selected, set the modality for import automatically or manually.

When setting to Automatic:

Select “Import by image Modality”.

When setting to Manual:

Select “Import to the following modality for the date selected”, and then select the modality from the pull-down menu. The modality created for the set date is displayed in the pull-down menu.

- * When the date and modality is set automatically, the image information file (a text file included when the image was exported from i-Dixel or i-Dixel WEB must be present with the 2D image to be imported.

4. Select the image to be imported. Note that it is possible to select multiple images.

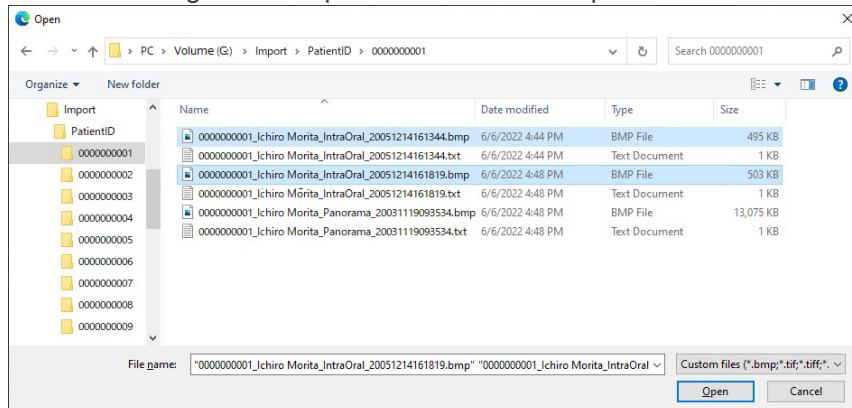

- * The text files shown in the figure are the image information files included with the 2D images.

5. When “Select date and modality for each image file” is selected in Step 3, the following dialog is displayed.

Set the target import date and the modality for import. There are two setting methods as explained in Step 3 - automatic settings and manual settings.

When using automatic settings, the image information file must be included with the 2D image.

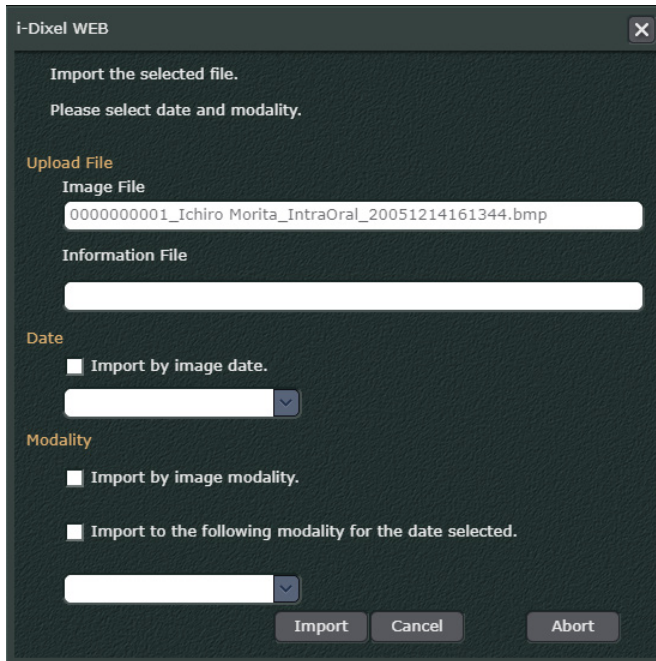

6. Once the import process is complete, the imported 2D image is displayed in the 2D viewer. When multiple 2D images are imported, the 2D image selected at the end in Step 4 is displayed.

[Importing from a TWAIN Device]

In order to import 2D images from a TWAIN device, you need to configure the TWAIN device according to our recommended settings and connect the TWAIN device to a computer.

1. Select (or search for) the patient to import on the “Home Page” to display the “main page.”
2. Click the “TWAIN” button () from the “Main Toolbar.” The “TWAIN Recorder” screen will appear.

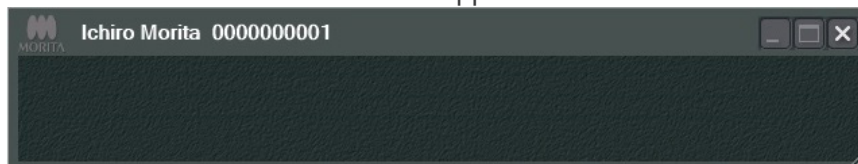

* “TWAIN Recorder” is an application that connects i-Dixel WEB to a TWAIN device.

Also, the “TWAIN Recorder Settings” dialog box will appear. Click on the “TWAIN” tab and set the following items.

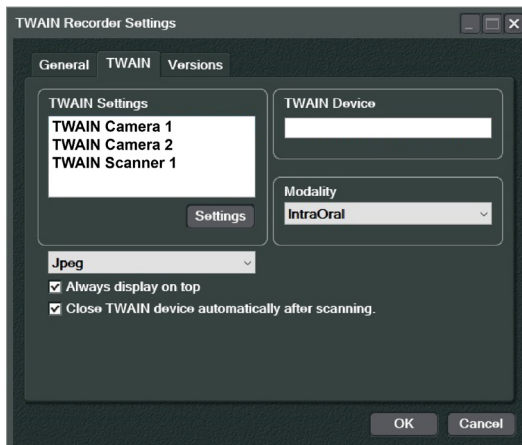

“TWAIN Settings”:

Select the TWAIN device from which you want to import and click the “Settings” button (). The TWAIN device from which you are importing is set to “TWAIN Device.”

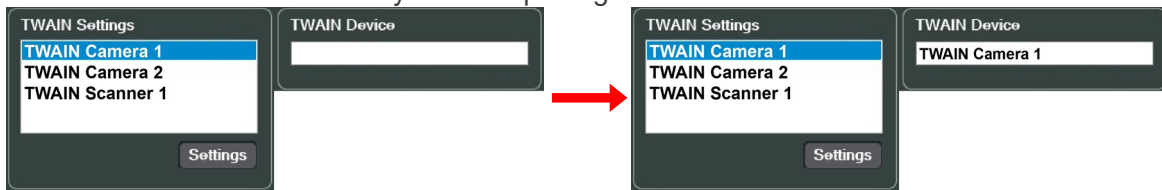

File format:

Select the file format of the image to be imported.

“Modality”:

Select the modality for the import destination.

“Always display on top”:

- Check
Display the “TWAIN Recorder” screen by pinning it to the foreground.
- Uncheck
Display the “TWAIN Recorder” screen without pinning it to the foreground.

“Close TWAIN device automatically after scanning”:

- Check
You can terminate the connection between i-Dixel WEB and the TWAIN device after importing images from the TWAIN device.
- Uncheck
You can terminate the connection between i-Dixel WEB and the TWAIN device by closing the “main page.”

* Unlike importing from recording media, you cannot set the date for the import destination. The date on which the images will be imported will be set automatically.

3. Click the “OK” button () and wait until the images are imported. The “TWAIN Recorder” screen will appear as shown below, indicating that the connection between i-Dixel WEB and the TWAIN device has been established.

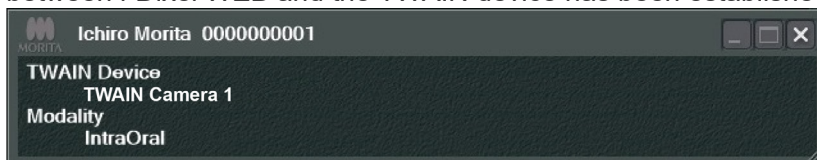

- After importing an image from the TWAIN device, the image will appear in the “2D Viewer” and the “TWAIN Recorder” screen will close.
If “Close TWAIN device automatically after scanning” is unchecked in the “TWAIN Recorder Settings” dialog, the next import will continue until you close the “main page.”

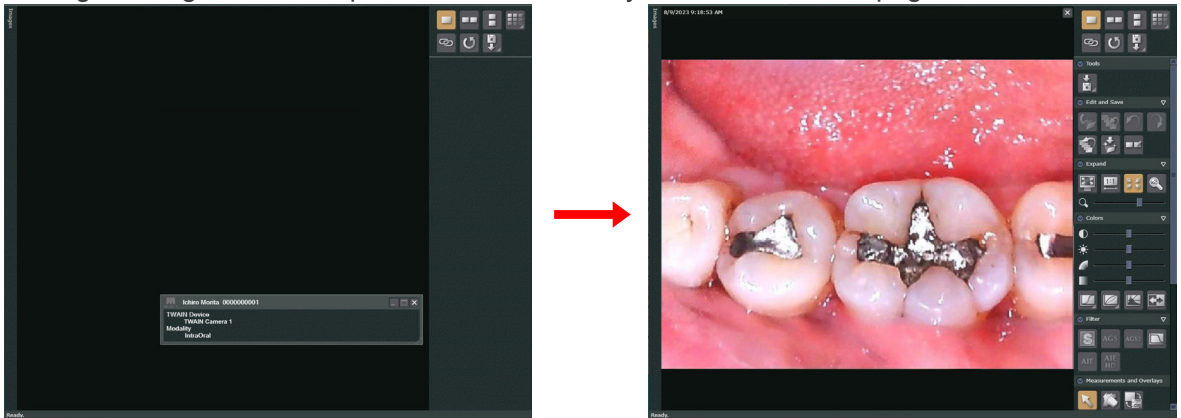

- * The “TWAIN Recorder Settings” dialog contains the following tabs.

“General” tab:

Click on the tab to set the “TWAIN Recorder” screen color and the destination for saving the records of connection (log files) with the TWAIN device.

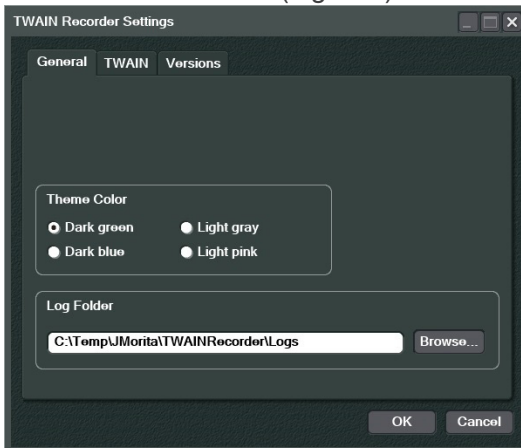

“Versions” tab:

Click on the tab to check the version of the “TWAIN Recorder.”

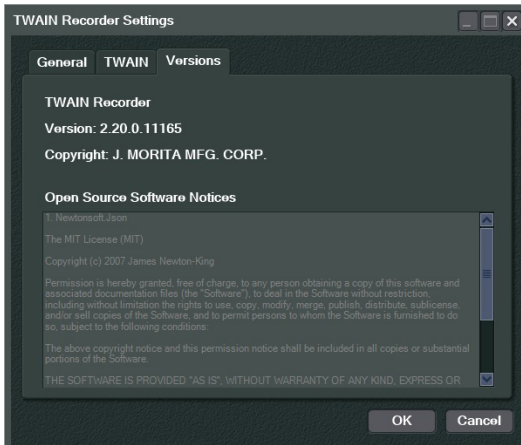

10. Edit 2D Images

2D images are selected and displayed in the 2D Viewer as explained on “2.2.1. 2D Viewer, 2D Images” (p. 16).

A list of available tools will appear in the Toolbox.

When the 2D Viewer is displayed, the title bar and other information will appear. For details, see “2.2. Main Page” (p. 5).

CAUTION

- *Using the Back button on the web browser to return to the 2D viewer may bring up some other display.*

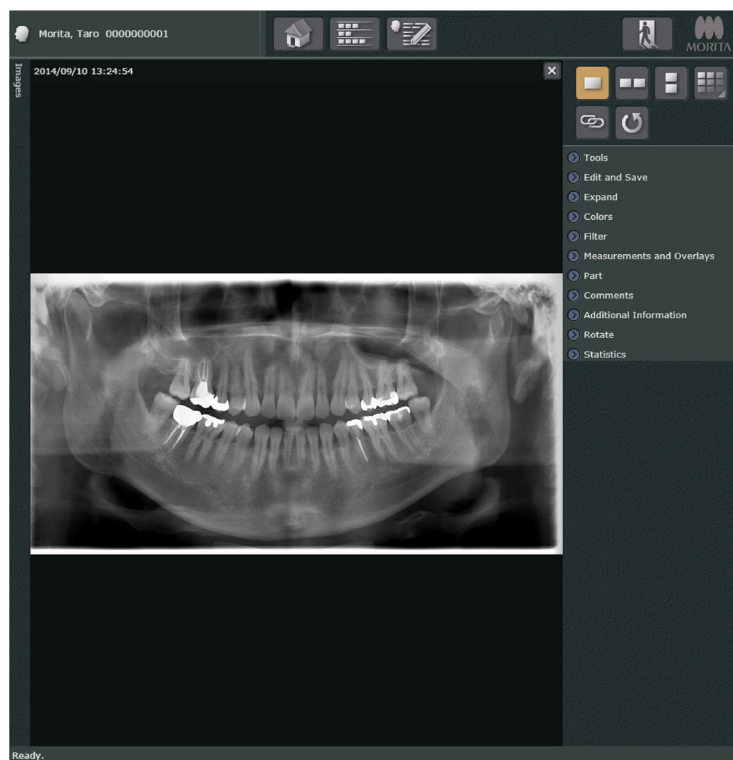

- * See “2.2. Main Page” (p. 5) for information about the toolbox.
- * Image search field and image list field are shown or hidden at the same time. For details, see “Image List” (p. 8).

Enlarge or Shrink Images

You can enlarge an image in the 2D Viewer by rotating the mouse wheel forwards, or conversely, shrink it by rotating backwards.

If an enlarged image is too big to fit in the screen, scroll bars will appear at the bottom and right side of it. You can also drag the image to reposition it.

For iPad or similar device users

You can enlarge images in the 2D Viewer by pinching out, and shrink them by pinching in.

If you enlarge an image by pinching out, you can then drag it to view parts that have gone out of the screen.

To Edit CT Images

As noted on “* Display CT image in 2D Viewer” (p. 17), the editing functions when viewing a CT image with the 2D Viewer are limited to “Edit and Save”, “Expand”, “Comments”, “Additional Information”, and “Compare”.

The following pages describe the functions of the various tools.

10.1. Tools

Exporting 2D Images.



Export a 2D image. Click the Export button to display the menu shown below.

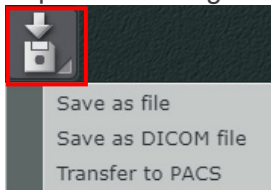

Select “Save as file” to save the 2D image to your device. Refer to “[Export 2D Images]” (p. 58).

Select “Save as DICOM file” to save the 2D image to your device in DICOM format.

Select “Transfer to PACS” to send the 2D image to a PACS in DICOM format.

* When “Save as file” or “Save as DICOM file” is selected, the image is exported in the download destination folder set in the Web browser.

* If the following screen is displayed when “Save as DICOM file” or “Transfer to PACS” is selected, set the values according to the instructions prompted on the screen.

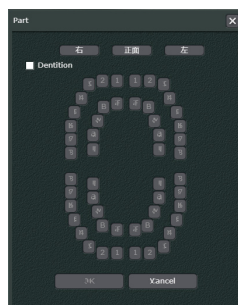
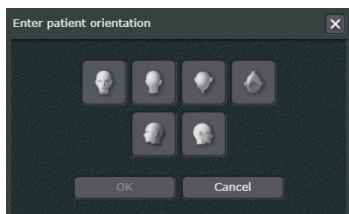
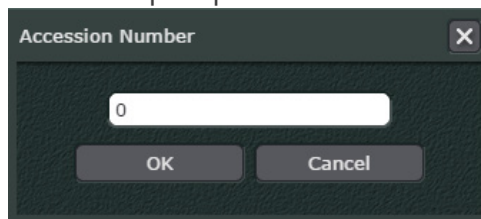
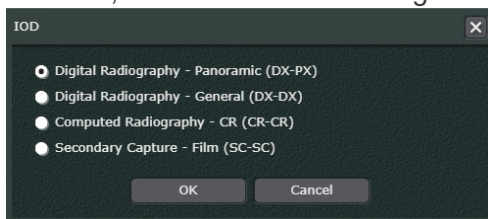

[Export 2D Images]

1. Click the Export button () in “Tools” in the 2D Viewer, and select “Save as file”.

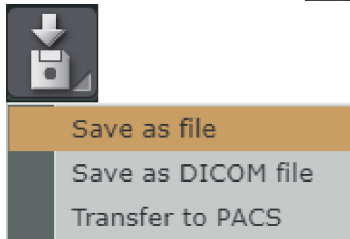

Or, right-click on the thumbnail in the image list and select “Save as file”.

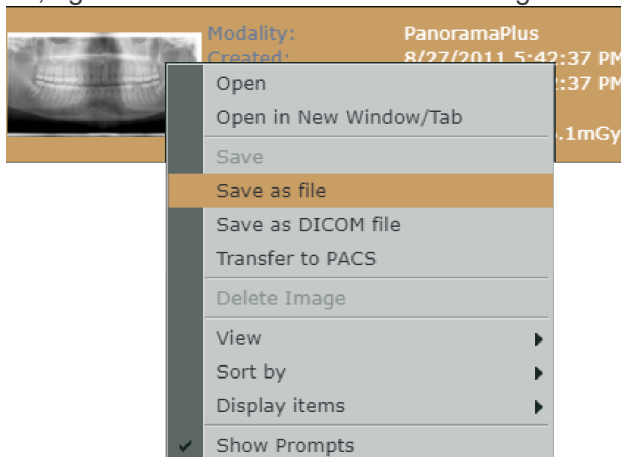

2. The following dialog is displayed. Select the file format of the 2D image to be exported.

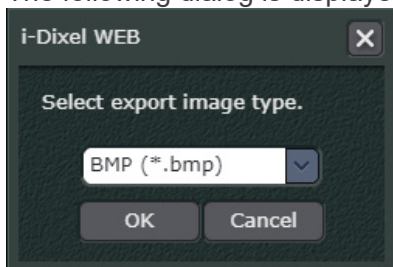

When exporting an image with annotations (such as graphics and characters) the following dialog is displayed after the file format is selected. Select “Yes” to convert to grayscale or “No” to retain the colors of the annotations.

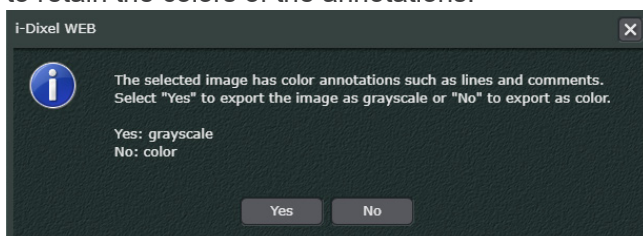

- The 2D image is compressed to ZIP format and exported to the download destination folder set in the Web browser.

An image information text file is included and exported along with the downloaded image.

- * In i-Dixel of the i-Dixel server PC, if “Information Overlay” is set in the “Export” view of the Settings and Maintenance Page as shown below, information such as the patient ID will be overlaid on the image and exported depending on the settings.

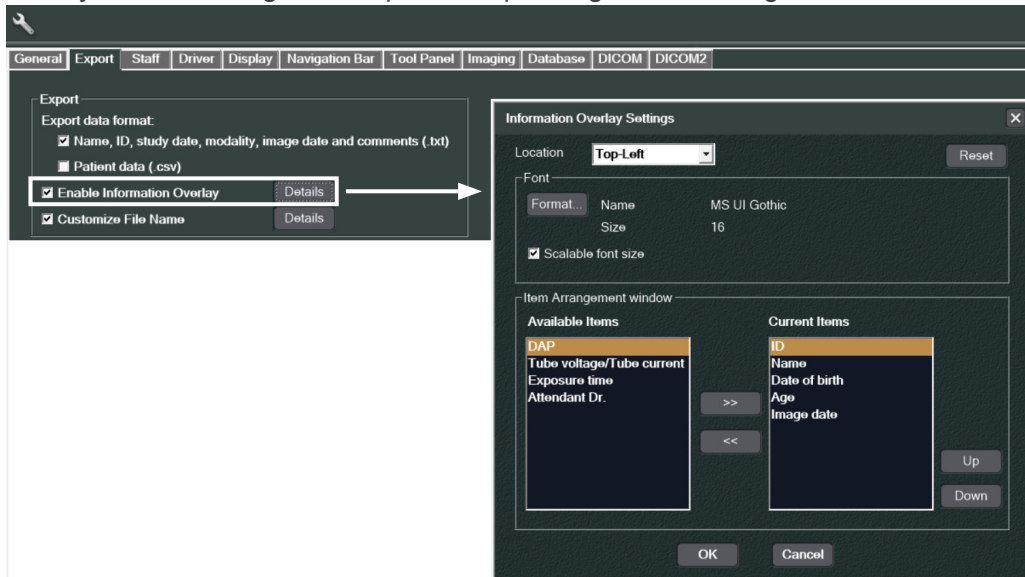

10.2. Edit and Save

Save an image edited in the 2D Viewer.

Until the image is saved, you can undo and redo the edit.

The original image (before editing) and the image currently being edited can be lined up and compared.



Save an edited version of the image (overwrite save).

- * This operation can be performed by another way. For details, see “A Symbol Displayed on Thumbnail Image” (p. 12).



Delete current version and go back to the previously saved version.



Undo the last editing action.



Redo the editing action you have undone. The Redo button only can be clicked after you have used the Undo button.



Delete all edited versions and go back to the original version.





Save an edited version of the image as a separate image.



Line up the original and image being edited and display in the full-screen mode.

The Triangle button (▾)

Clicking the Triangle button (▾) in the upper right corner will show or hide three buttons (  ).

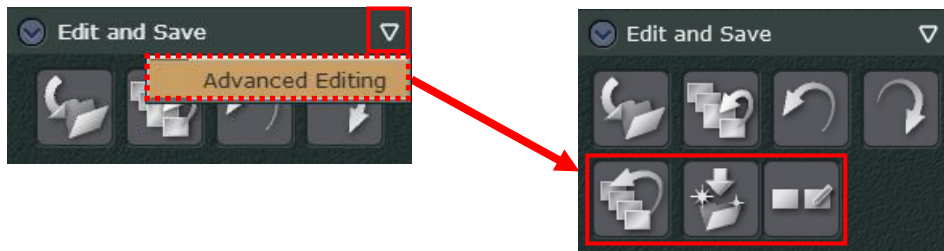

Caution about Saving Changes

Saving changes to image files is not possible in the following cases.

- 1) Changes cannot be saved if the patient is already selected in the i-Dixel application on the i-Dixel computer.
In this case, save changes by going to the i-Dixel Home Page.
 - * If the patient is already selected by the i-Dixel application, “(Read Only)” will appear on the title bar of main page.

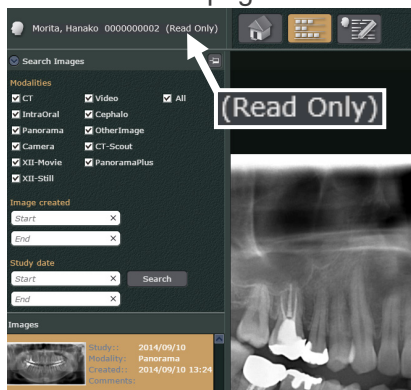

This means changes cannot be saved on the original file, but they can be saved as a new file.

- 2) If the same file is being display in two separate browser windows, changes cannot be saved in one window if some changes have already been saved in the other window.
In this case, the following dialog is displayed.



If you save the file, you click the OK button each the dialogue boxes and need to discard the change for the file. If you change the file after reloading the file, you could save the latest changes as a new, separate file.

Also, If you change the file after selecting the same patient and file for a single browser window, you can save the latest changes as a new file.
This is also true if the same file is being displayed in multiple tabs for a single browser window.

Logout or Return to i-Dixel Home Page without Saving Changes

A dialogue box will appear if you try to logout or return to the home page without saving changes made to images. It will include the thumbnails of images for which you have not saved changes.



Click **Save All** to save the changes and logout or go back to the home page.
Click **Discard All** to logout or go back to the home page without saving any of the changes.
Click **Cancel** to forego logging out or going back to the home page and return to the previous screen.

Or you can select one or more of the thumbnails.



This will activate the “**Save Selected**” and “**Discard Selected**” buttons.
Click the “**Save Selected**” button to save the changes for selected images.
Click the “**Discard Selected**” button to discard the changes for selected images.

Display the Original and Currently Being Edited Images

Click () to line up the original (before editing) and image currently edited and display in full-screen mode.

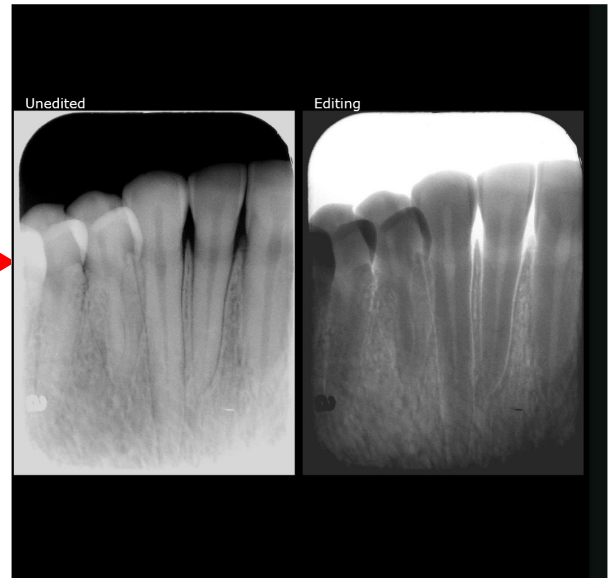
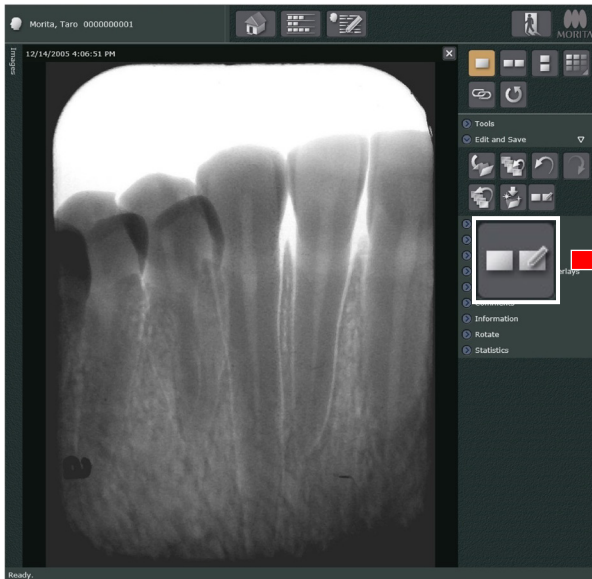

If you rotate the mouse wheel, image size can be changed.



Right-click the image to see a shortcut menu.

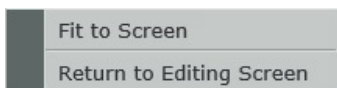

“Fit to Screen”
Image size will be back to original.

“Return to Editing Screen”
Exit the full-screen mode and return to the editing screen.
Also, double-click an image to exit the full-screen mode.

- * When the original and currently being edited images are lined up and displayed in full-screen mode, you cannot edit the image.
- * If you click () while comparing images according to “8. Image Comparison Display” (p. 37), the images you selected will be lined up and displayed in full-screen mode.

10.3. Expand

Enlarge or Shrink Image

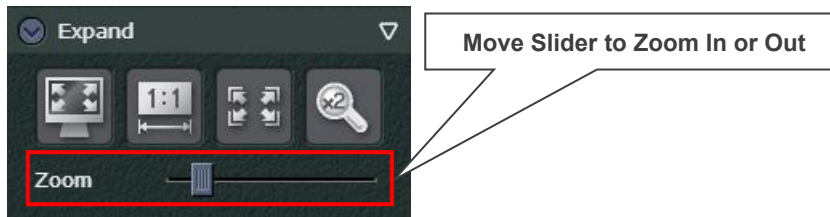

- * You can zoom in and out in ways other than using the “Zoom” slider.
See “Enlarge or Shrink Images” (p. 57) and “For iPad or similar device users” (p. 57).



Click this button for the full screen display of the Web browser.
See “Full Screen Display” (p. 65).



Set zoom ratio.



Enlarges or shrinks image to match size of 2D Viewer.



Use this to magnify a part of an image.
See “Magnify Part of an Image” (p. 66).

The Triangle button (▾)

Clicking the Triangle button (▾) in the upper right corner will show or hide a “Zoom” Slider.



Full Screen Display

You can use the full screen display in the following ways.
Right-click the display and select "Cancel Full Screen" to return to the regular display.

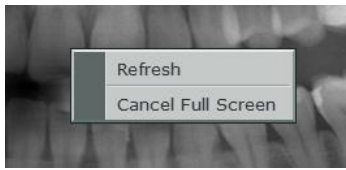

You can also press the Esc key.

Enlarge or Shrink Image

Rotate the mouse wheel forward to enlarge.
Rotate it backwards to shrink.

Example: Enlarge Image

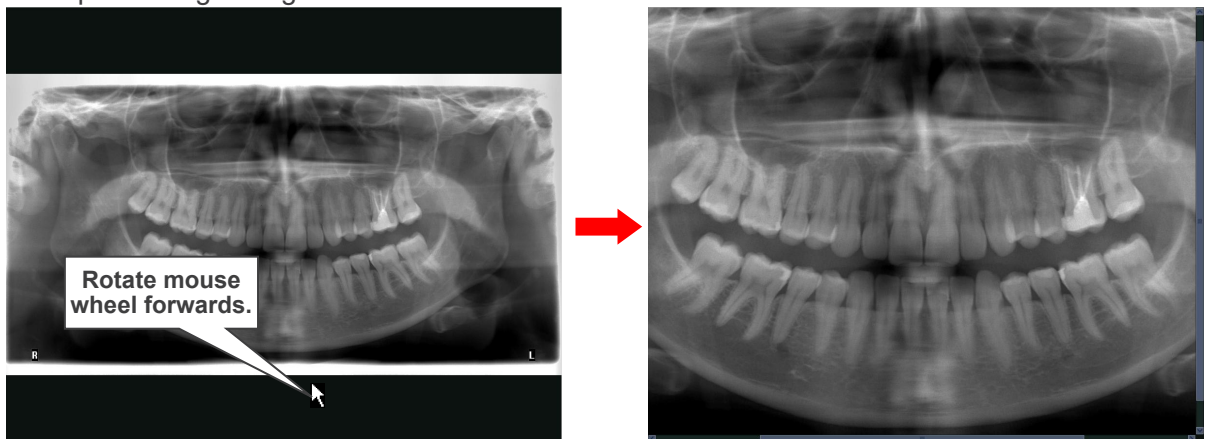

After enlargement the mouse scroll bars will appear at the bottom and right side.

Select Area of Enlarged Image

Drag with the mouse on the bottom or right side of the image to move it and select the area for viewing. You can also use the scroll bars.

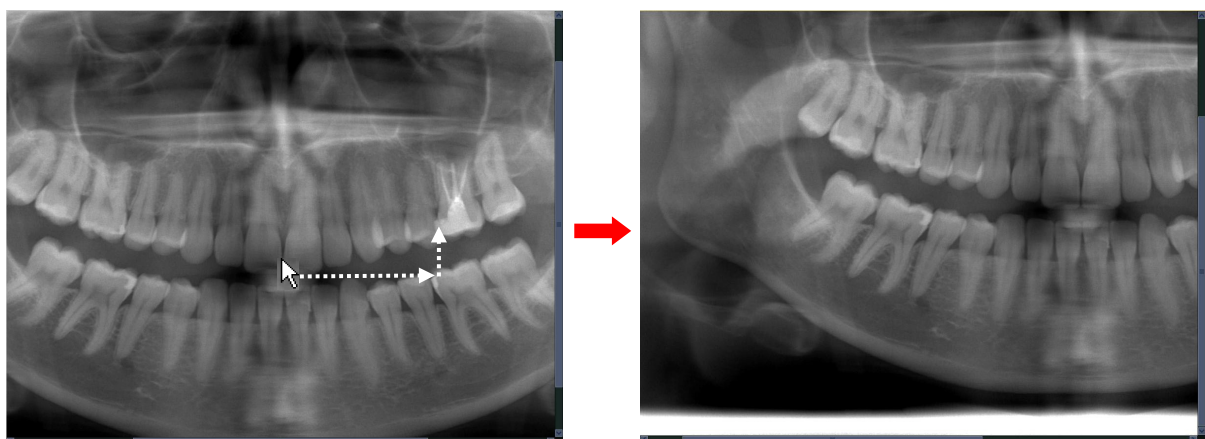

Magnify Part of an Image

You can magnify an image and make it twice as big. The magnification ratio cannot be changed.

1. Click this button .
Put the mouse cursor on the image. It will have the shape shown below.



2. Move the plus sign (+) to the center of the area you wish to magnify and click.

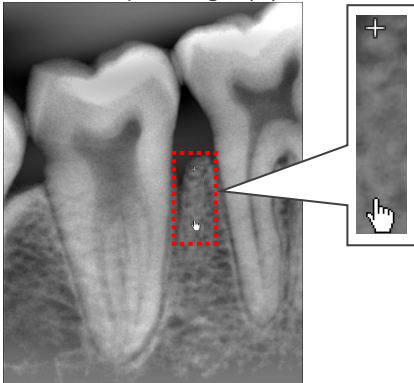

3. The area surrounding the point clicked will be magnified.

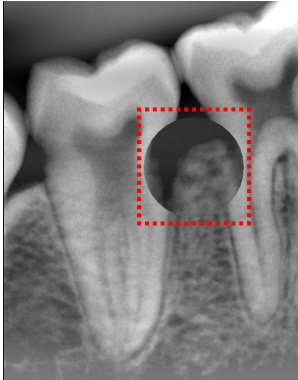

Right-click to display the slider.

Move the slider to adjust the size of the magnified area.

Move the slide to the right to expand the magnified area and vice versa.

Example: Expand magnified area

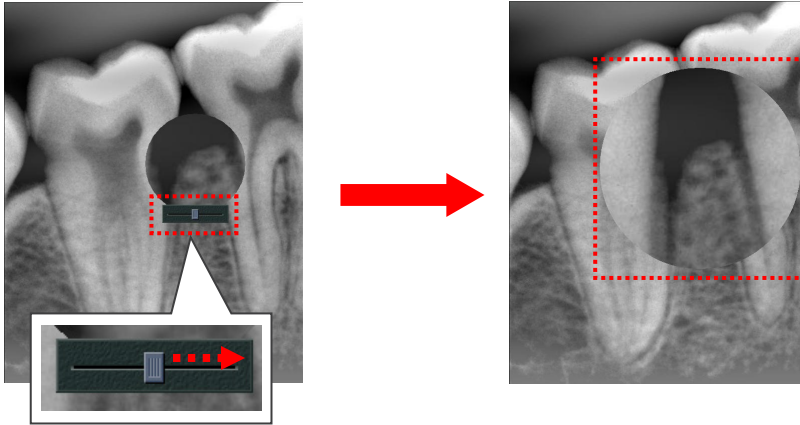

Cancel Magnify Button

Click this button () again to cancel it. The mouse will go back to its original shape.

10.4. Colors

Adjust image brightness, contrast, etc. as well as making these adjustments with gamma correction.



1. Contrast
2. Brightness
3. Hue for color images
4. Saturation for color images

- * Contrast can be adjusted by right-clicking the mouse on the image and dragging horizontally.
- * Brightness can be adjusted by by right-clicking the mouse on the image and dragging vertically.
- * Hue and saturation are displayed only when viewing a color image.



This is effective if the contrast for the display monitor cannot be adjusted properly.
See “Sigmoid” (p. 70).

- * This tends to increase contrast.



This is effective if the brightness for the display monitor cannot be adjusted properly.
See “Gamma Filter” (p. 70).



Automatically optimizes contrast and brightness.



Reverses black and white

The Triangle button (▾)

Clicking the Triangle button (▾) in the upper right corner will show or hide the following four buttons (   ).

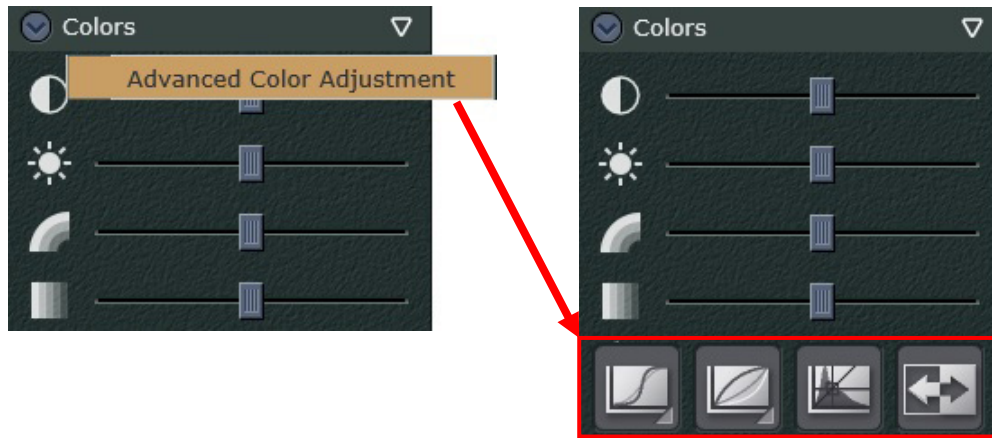

Sigmoid

The sigmoid function can be used to adjust the contrast of the monitor. It can also be used if the contrast slide (see p. 68) does not work well enough. Click the button and select the type of contrast adjustment you wish. "Sigmoid 2" is more drastic than "Sigmoid 1".



Select the item again to cancel it. This cannot be used combined with the Gamma Filter: .

Gamma Filter

If the brightness for the monitor cannot be properly adjusted, the Gamma Filter can be used for better adjustment. It can also be used if the brightness slider (see page 68) does not work well enough. Click this button and select the type of Gamma Filter you wish.



- "Gamma 2.00" Use this if Gamma 1.33 is not good enough.
- "Gamma 1.33" Gamma value 1.33 Filter
- "Gamma 0.67" Gamma value 0.67 Filter
- "Gamma 0.50" Use this if Gamma 0.67 is not good enough.

Select the item again to cancel it. This cannot be used combined with the Sigmoid: .

Gamma Value and Gamma Correction

Density and brightness are proportional.

The gamma value expresses this proportional relationship.

If the gamma value is right, this proportional relationship is normal.

If the density is lower, the image will be darker, and conversely, if the density is higher, the image will be brighter. This results in the natural or normal brightness.

If the gamma value is not right, the image will not have its natural and normal brightness.

Gamma correction can remedy this and display the image with its natural and normal brightness.

CAUTION

- ***Gamma correction is only for obtaining the appropriate brightness by correction the proportional relationship between the density and brightness. It should not be used to improve the quality of the monitor or to compensate for a defective monitor. To improve image quality we recommend using filters and contrast adjustment.***

10.5. Filter

Filters can be used to enhance image quality if the original is degraded or lacks clarity resulting in spike noise, moiré patterns, or stripes.

They can also be used to highlight outlines, uneven surfaces, shading etc.



Sharpness Filter:

Sharpens image.

See “Examples of Filter Applications” (p. 73).



AGS (Adaptive Gray Scale) Filter:

This automatically adjusts brightness for optimum observation of not only the dental arch but the jaw, TMJ and entire panorama image. AGS (Adaptive Gray Scale) can only be used for the “Panorama” and “PanoramaPlus” modalities.

It cannot, however, be used for the TMJ quadruple or maxillary sinus images.



AGS2 (Adaptive Gray Scale 2) Filter:

This automatically adjusts brightness and contrast for optimum observation of not only the dental arch but the jaw, TMJ and entire panorama image. AGS2 (Adaptive Gray Scale 2) can only be used for the “Panorama” and “PanoramaPlus” modalities.

See “Examples of Filter Applications” (p. 73) for examples.



Other Filter:

This is for filters other than Sharpness·AGS·AGS2·AIE·AIE HD

See “Other Filters” (p. 77) for detail.

See “Examples of Other Filters” (p. 78) for example.



AIE (Auto Image Enhancement) Filter:

This filter produces even contrast and brings out characteristic features regardless of the size of the exposure region or the area of the exposure. It sharpens image quality for any 2D image including those for teeth, periodontal tissue, jaw bone, or facial regions. This filter can only be used for 2D images saved “Panorama”, “PanoramaPlus” and “Cephalo” modality.

See “Examples of Filter Applications” (p. 73) for example.

AIE HD

AIE HD Filter:

In addition to evening out the contrast with the AIE feature, this reduces the artifacts near metal prosthetic devices to produce a smoother image. AIE HD can only be used for 2D images in the “Panorama” or “PanormaPlus” modality.

See “Examples of Filter Applications” (p. 73) for example.

The Triangle button (▾)

Clicking the Triangle button (▾) in the upper right corner will show or hide three buttons

(S AGS AGS2).

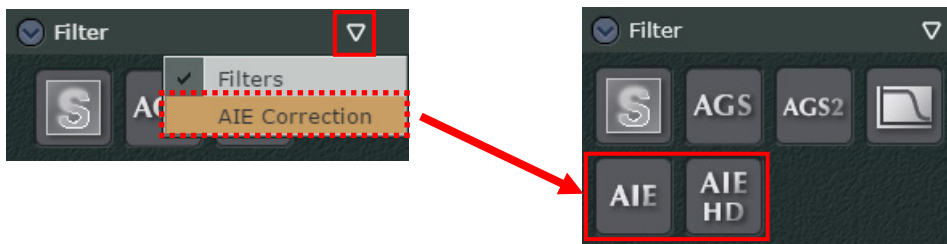

Clicking the Triangle button (▾) in the upper right corner will show or hide two buttons

(AIE AIE HD).

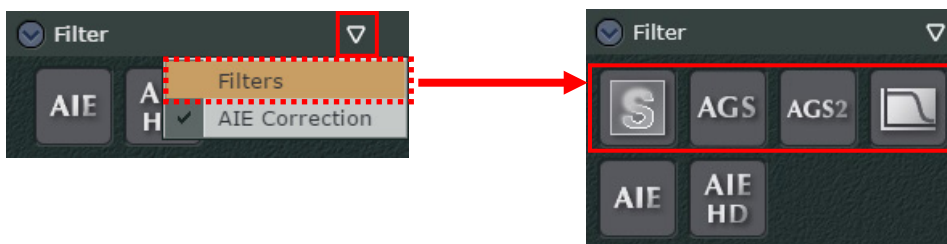

⚠ CAUTION

- *Processing with this filter may take some time if the image is relatively large.*

Examples of Filter Applications

Examples of using the Sharpness, AGS (Adaptive Gray Scale), AGS2 (Adaptive Gray Scale 2), AIE (Auto Image Enhancement) and AIE HD (Auto Image Enhancement) filters.

Sharpness

Sharper image.

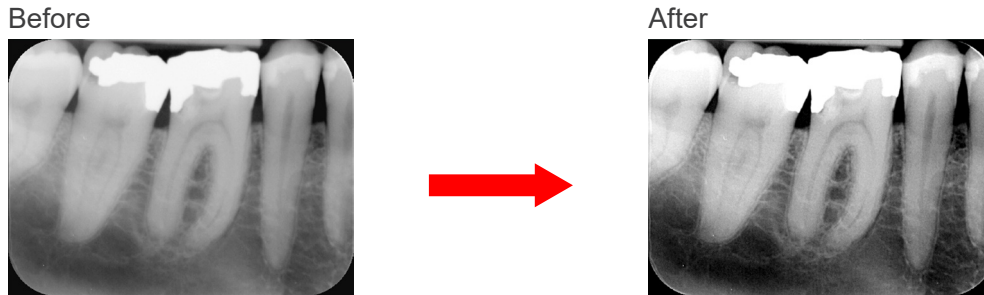

AGS (Adaptive Gray Scale)

This automatically adjusts brightness for optimum observation of not only the dental arch but the jaw, TMJ and entire panorama image. AGS (Adaptive Gray Scale) can only be used for the "Panorama" and "PanoramaPlus" modalities.

It cannot, however, be used for the TMJ quadruple or maxillary sinus images.

- Before

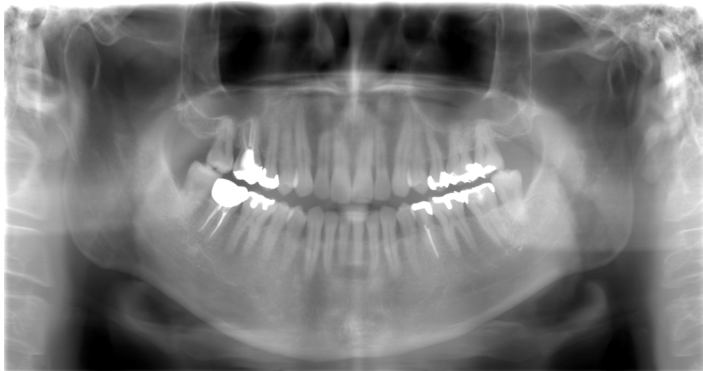

- After AGS Filter Application



⚠ CAUTION

- **AGS automatically optimizes density regardless of the region. However it is not suitable for inflammation over a large area such as odontogenic maxillary sinusitis (maxillary sinusitis due to dental caries), asymmetries etc. In these cases, diagnosis should be based on observation of images both before and after AGS processing.**

AGS2 (Adaptive Gray Scale 2)

This automatically adjusts brightness for optimum observation of not only the dental arch but the jaw, TMJ and entire panorama image, obtaining an image with a stronger contrast than with AGS. AGS2 (Adaptive Gray Scale 2) can only be used for the "Panorama" and "PanoramaPlus" modalities.

- Before

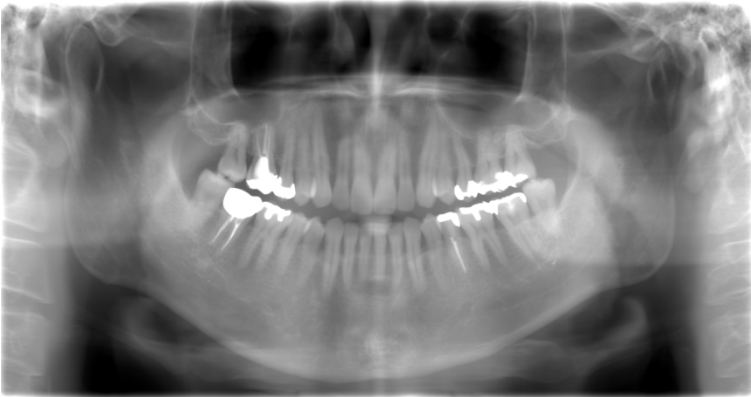

- After AGS Filter Application



- After AGS2 Filter Application



CAUTION

- *AGS2 optimizes brightness so that all regions can be easily observed, obtaining an image with more enhanced contrast than when using AGS. However, AGS2 is not suitable for observation of some cases since it enhances the shadow of the cervical vertebrae, makes the maxillary sinus opaque on both sides, etc. In these cases, diagnosis should be based on observation of images both before and after AGS2 processing.*

AIE (Auto Image Enhancement)

This filter produces even contrast for sharper images.

AIE can only be used for 2D images saved "Panorama", "PanoramaPlus" and "Cephalo" modality.

- Before



- After Increasing Contrast



* See "10.4. Colors" (p. 68) for adjusting contrast.

- After AIE Filter Application



AIE HD

In addition to evening out the contrast while taking the characteristic features of part, this reduces the artifacts near metal prosthetic devices to produce a smoother and sharper image. AIE HD can only be used for 2D images saved "Panorama", and "PanoramaPlus" modality.

- Before

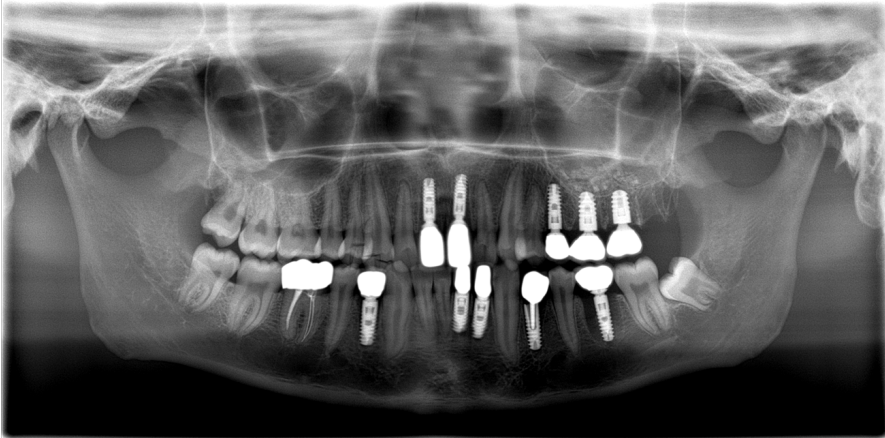

- After Increasing Contrast

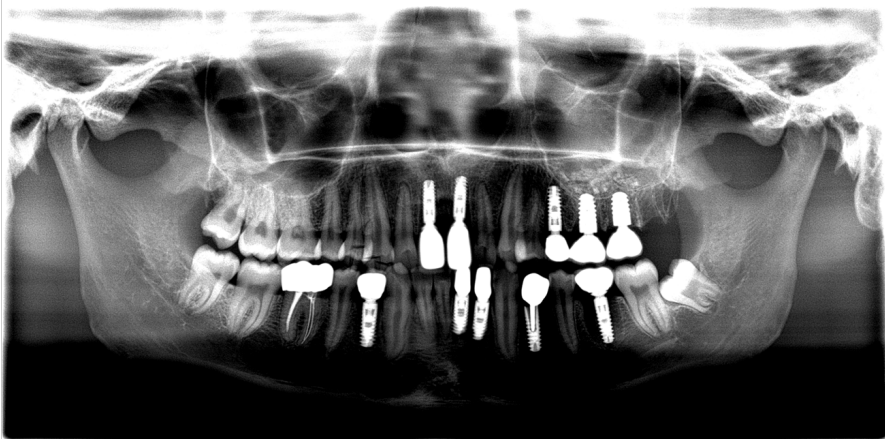

* See "10.4. Colors" (p. 68) for adjusting contrast.

- After AIE Filter Application

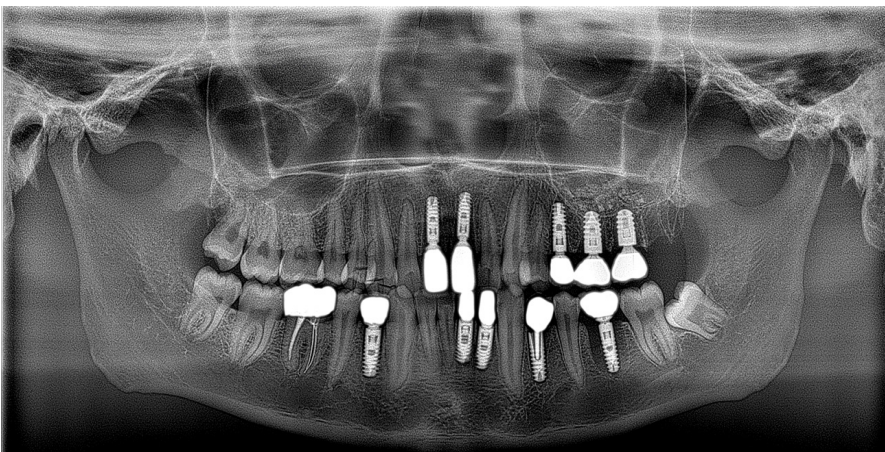

Other Filters

For filters other than Sharpness, AGS, AGS2, AIE and AIE HD, click the button and select the filter.

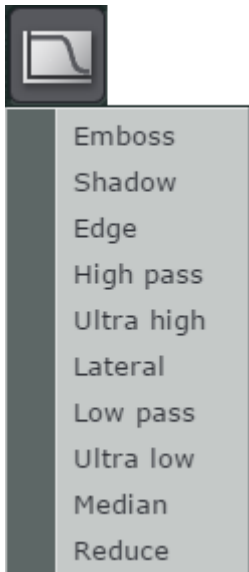

“Emboss”:	2D images have raised and lowered areas like a clay mode. Prosthetics tend to be raised and caries lowered.
“Shadow”:	2D images appear three-dimensional with shadows.
“Edge”:	Emphasis outline of 2D images
“High pass”:	Only applied to areas with large differences in density for 2D images. Sharpens image.
“Ultra high”:	Use if “High pass” is not good enough. Increases contrast. Sometimes eliminates gray areas and produces an entirely black and white image.
“Lateral”:	Evens out and increases contrast for any area exposure. * Evens out and increases contrast for all parts of Panorama and Cephalo images. Not as effective as AIE.
“Low pass”:	Only applied to areas with small differences in density for 2D images. Eliminates roughness and makes a smoother image.
“Ultra low”:	Use if “Low pass” is not good enough. Creates smoother image. This might eliminate all black and white areas leaving only gray and resulting in a blurry image.
“Median”:	Compares density of neighboring pixels and gives them an average value. Pixels with a very different density are given an average value. Good for eliminating spike noise with minimal change to the image.
“Reduce”:	Eliminates moiré patterns (wavelike stripe noise) for 2D images with minimal change to the image. Useful for eliminating the moiré pattern in simple X-rays exposures

CAUTION

- *For large 2D images, it may take some time for the filter to process the image, except for the “Edge” and “Median” filter.*

Examples of Other Filters

Examples of “Emboss”, “Shadow”, “Edge”, “High pass”, “Low pass”, “Lateral”, and “Median” Filters.

“Emboss”

Bas Relief Effect

• Before

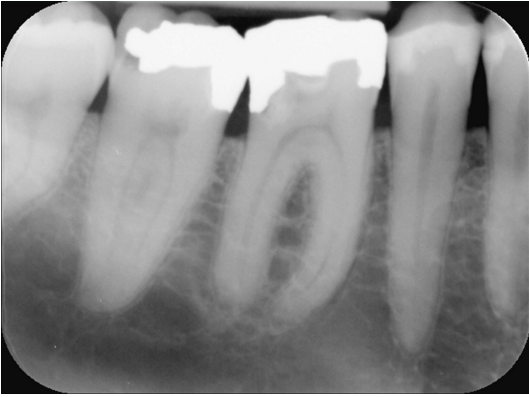

• After

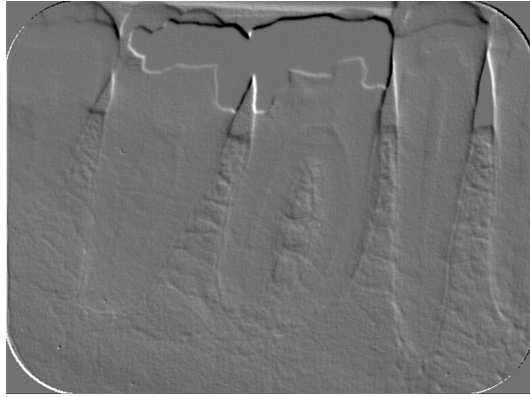

“Shadow”

Three-dimensional with shadows.

• Before

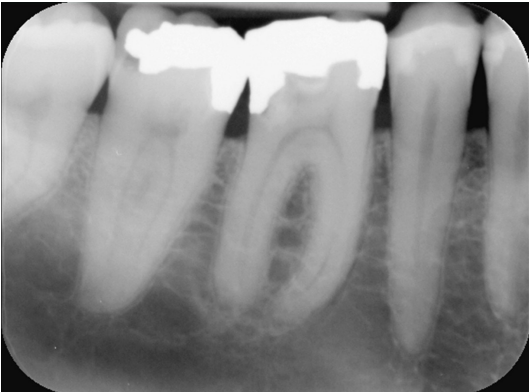

• After



“Edge”

Emphasizes outline.

- Before



- After

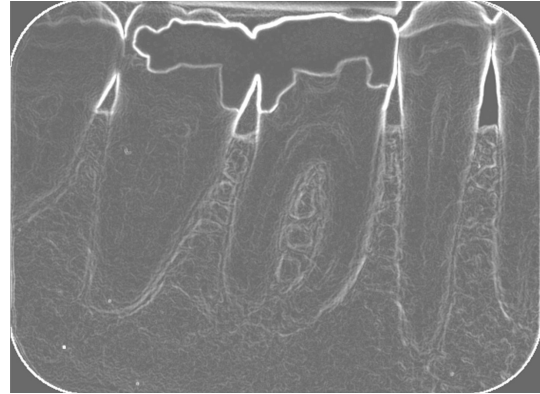

“High pass”

Sharper image.

- Before



- After



“Low pass”

Smoother image.

- Before



- After



“Lateral”

Evens out contrast for sharper image.

- Before



- After increasing Contrast



- After “Lateral”



* For adjusting contrast, see “10.4. Colors” (p. 68).

“Median”

Eliminates spike noise.

- Before

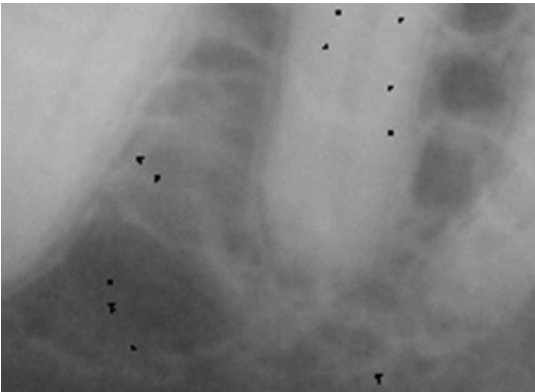

- After



* With the size of a spike noise, it may be completely eliminated.

Applying Multiple Filters

Sharpness and the AIE or AIE HD filters can be used simultaneously.

The AGS filter can be used with the AIE or AIE HD filter.

The AGS2 filter can be used with the AIE or AIE HD filter.

Other filters may also be used with the AIE or AIE HD filter.

Sharpness, AGS, AGS2 and other filters cannot be used simultaneously.

The AIE and AIE HD filters cannot be used simultaneously.

No more than one of the other filters can be selected.

For example, "High pass" and "Median" cannot be selected simultaneously.

Cancel Filter

The button for the filter selected will be highlighted.

Example: Sharpness filter is selected.



Click the button again to cancel the filter.

The button will no longer be highlighted.

The Other Filters button will be highlighted and the selected filter will be marked with a check.

Example: "High pass" filter is selected.



Select the filter again to cancel it.

The check mark will disappear and the button will no longer be highlighted.

10.6. Measurement and Overlays

Length, angle, and density measurements can be made.
Letters, symbols, and lines can be added on the image.

- * In this manual, letters, symbols, and figures drawn on the image are collectively described as an object. Also, figures written for measuring length, angle, and density are collectively described as an object.
- * Objects colors can be saved separately for each user that logs in i-Dixel WEB.
Colors can also be saved separately for terminal types (personal computer, tablet computer) used.
For example, the same user can use a different color for each different terminal type.



Used to select objects on the image.
Also used to cancel other Measurement and Overlays buttons.



Used to erase objects.
See “Erase objects” (p. 92).



Show or hide objects.



Length Measurement.
See “Length Measurement” (p. 84).



Angle Measurement
See “Angle Measurement” (p. 87).



Write comment etc.
See “Text Overlay” (p. 89).



Draw symbol data.
Symbol data refers to the RL symbol for panorama images, area codes, and scales.
See “Symbol Overlay” (p. 90).



Draw a line on the image to measure the density value along the line.
See “Line Profile Measurement” (p. 93).



Draw a rectangle on the image to measure the density of minimum, maximum, and average density values, as well as the standard deviation of the density of inside the area.
See “Area Profile Measurement” (p. 94).



Draw a straight line. Drawing with the Shift key pressed draws a horizontal or vertical line.



Draw a rectangle shape.



Draw an ellipse shape.



Draw a polygon shape.



Draw a curved line freehand.



Draw an arrowed line. Drawing with the Shift key pressed draws a horizontal or vertical arrow.



Draw a horizontal or vertical line.

Length Measurement

Warning

- *Note that length measurements will be slightly erroneous due to the principles for X-ray exposures etc. This must be taken into consideration to obtain accurate measurements. For detail see “17.1. Cautionary remarks for distance measurements” (p. 223).*

1. Click this button ().
2. Click a point to start the measurement and then draw a line with the mouse.

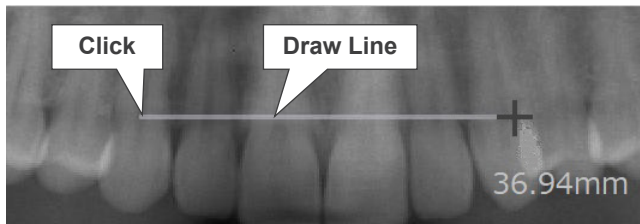

3. Double-click to mark the end point. The measurement results will appear.

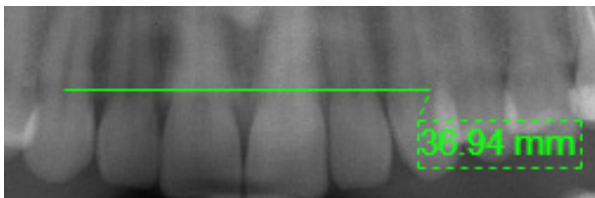

Measure a Broken Line

Click once to start the next segment. Double-click to mark the end point.

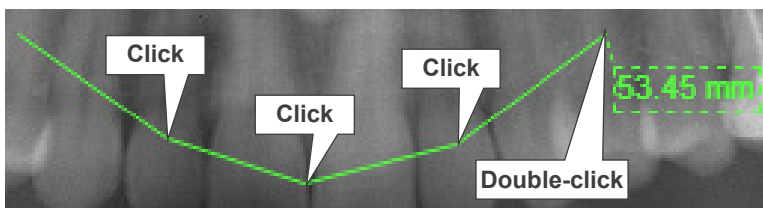

Change Results Display

Right-click on the results to bring up the pop-up menu.

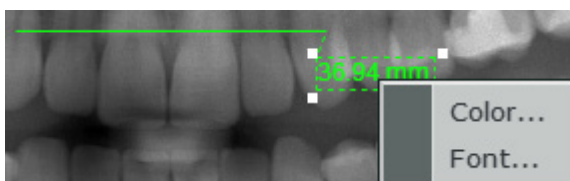

Select “Color...” to change the color.
Select “Font...” to change it.

Change Line Display

Right-click on the line to bring up the pop-up menu.

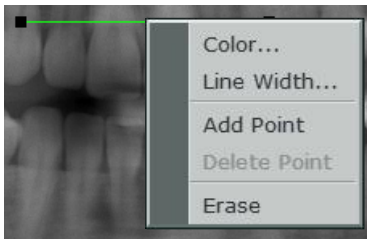

Select "Color..." to change its color.
Select "Line Width..." to change its width.
Select "Add Point" to add a point on the line.

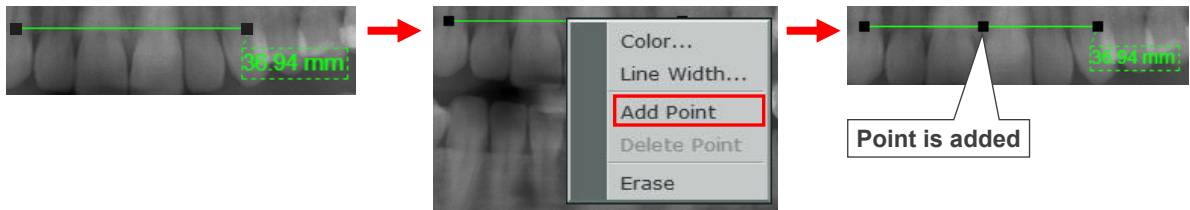

Dragging the added point will change the shape of the line.

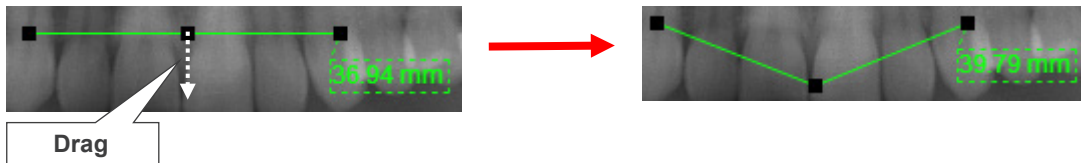

Select "Delete Point" to delete the added point.
Right-click on the added point and select "Delete Point" to delete the added point and return the line to its original form.

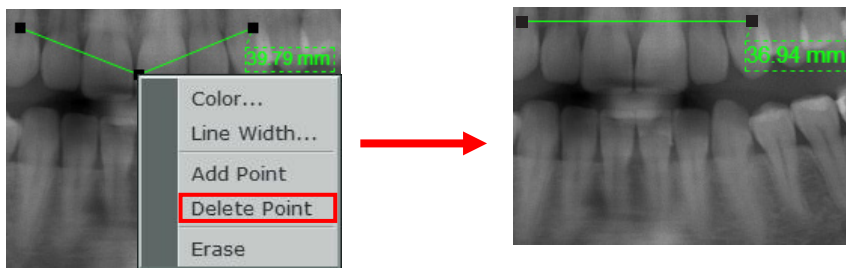

Select "Erase" to delete the line altogether.

If measurement is calculated in number of pixels

If the resolution or magnification of the image is not specified, the measurement results will be in number of pixels.

Measurement results can be made by setting the resolution (pixel size) with the i-Dixel application.

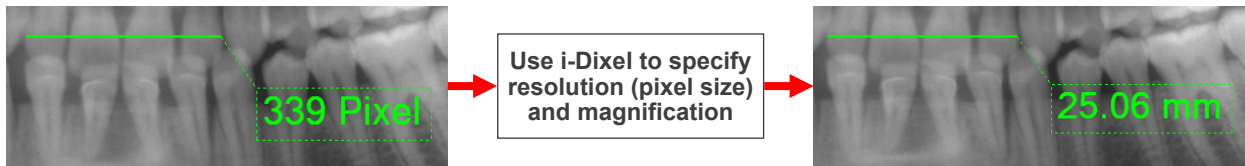



Even if the measurement results are obviously inaccurate, this can be corrected by using the i-Dixel application to specify the actual resolution (pixel size) and magnification.

* Resolution (pixel size) and magnification cannot be specified with the i-Dixel WEB application.

Angle Measurement

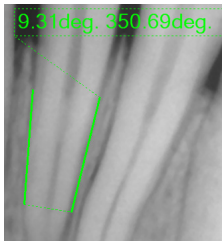
Measure the angle made by two lines and an auxiliary line.



1. Click this button .
2. Click to make the starting point for the first line.
Draw the line and click again. This will mark the end of the line and also the beginning of an auxiliary line.
Draw the auxiliary line and click again. This will mark the beginning of the second line.
Draw the second line and click.

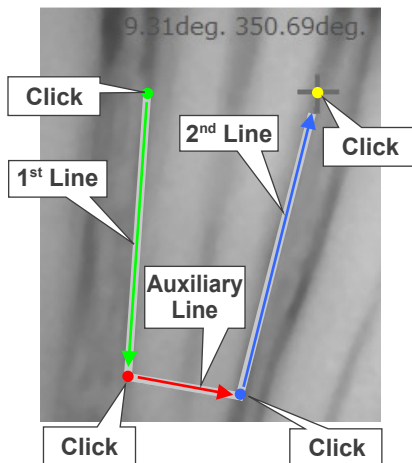

3. The angle (Φ) measurement will appear.

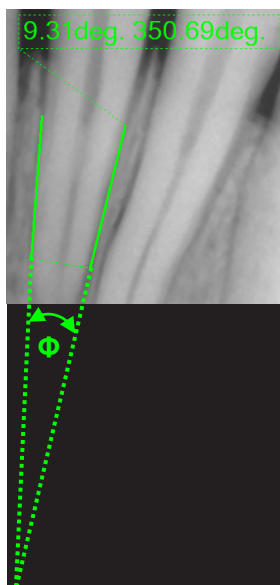

Color and Fonts for Measurement Results

Right-click the measurement results to bring up the Color and Font pop-up menu.

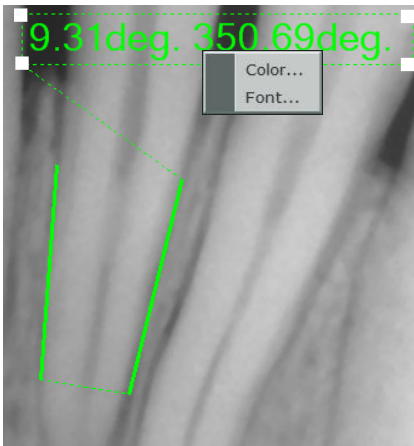

Select "Color..." to change the color.
Select "Font..." to change the font.

Change Color or Width of Main and Auxiliary Lines or Erase Them

Right-click a main or auxiliary line to bring up the pop-up menu shown below.



Select "Color..." to change the color.
Select "Line Width..." to change it.
Select "Erase" to erase it.

Text Overlay

You can add text to 2D images.

1. Click this button (.
2. Click on the place for adding text. A cursor will appear.

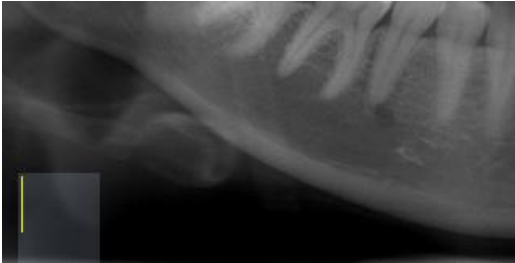

3. Enter your text, and then click on this button (.

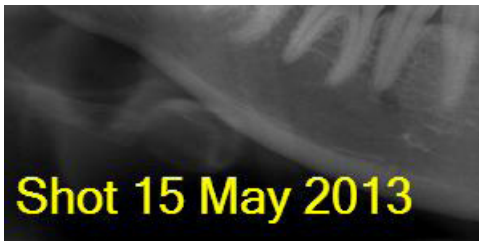

- * Press the Enter key to start a new line.
- * Click on the text to bring up the pop-up menu shown below.
 - Select "Color..." to change the color.
 - Select "Font..." to change it.
 - Select "Edit Text..." to change the text.
 - Select "Erase" to delete the text altogether.

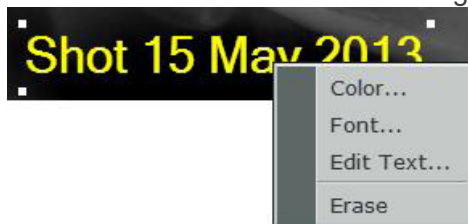

Symbol Overlay

You can add symbol data upon the 2D images.

The available symbol data types are RL characters, area codes, and scales.

- * When you wish to add symbol data to 2D images whose pixel size and magnification ratio are not set, you will need to set the pixel size and magnification ratio in order to be able to calculate the measurement result.

When the pixel size and magnification is not set, set in the i-Dixel application.

The pixel size) and magnification cannot be set with the i-Dixel WEB application.

Example: Add symbol data – RL characters

1. Click this button ().
2. Click on the image to bring up the Add Symbol dialogue box.

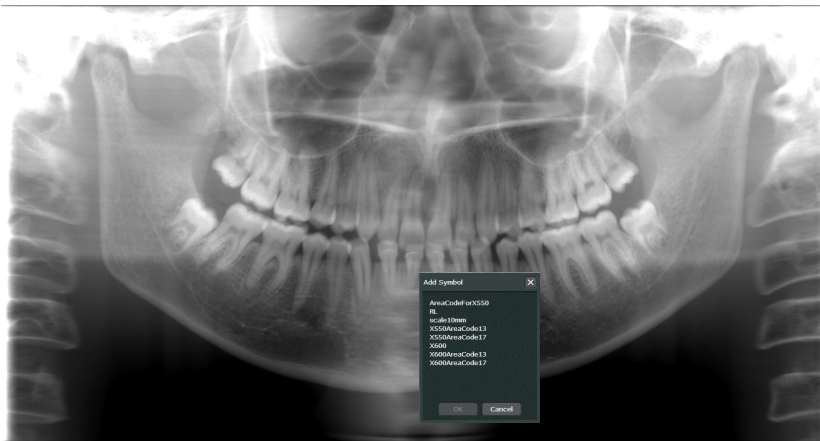

Select “RL”, and then click the OK button.



List of Data Symbols that can be overlaid

Data Name	Description
"AreaCodeForX550"	Area codes which have been prepared to be used for panorama images taken by film cassette, those provided by IP systems of other manufacturers, and those imported from other media.
"RL"	RL characters prepared to be used for panorama images.
"scale10mm"	The scale prepared to enable confirmation of 10 mm scale.
"X550AreaCode13"	Area codes which have been taken by Veraviewepocs to be used for panorama images magnified at the scale factor of 1.3 of the standard panorama images.
"X550AreaCode17"	Area codes which have been taken by Veraviewepocs to be used for panorama images magnified at the scale factor of 1.7 of the magnified panorama images.
"X600.smbI"	Area codes which have been prepared to be used for panorama images taken by film cassette, those provided by IP systems of other manufacturers, and those imported from other media.
"X600AreaCode13"	Area codes which have been taken by Veraviewepocs to be used for panorama images magnified at the scale factor of 1.3 of the standard panorama images.
"X600AreaCode17"	Area codes which have been taken by Veraviewepocs to be used for panorama images magnified at the scale factor of 1.7 of the magnified panorama images.

* AreaCodeForX550: and X600: are symbol data types prepared with the width across the film face set as 300 mm. When you wish to add these symbol data, make sure to set the magnification ratio to "1.0" and to calibrate the pixel size and magnification ratio using the i-Dixel application. (Resolution (pixel size) and magnification cannot be specified with the i-Dixel WEB application.)

- The RL character symbol data will be added. You can move the added symbol data by drag & drop operation.

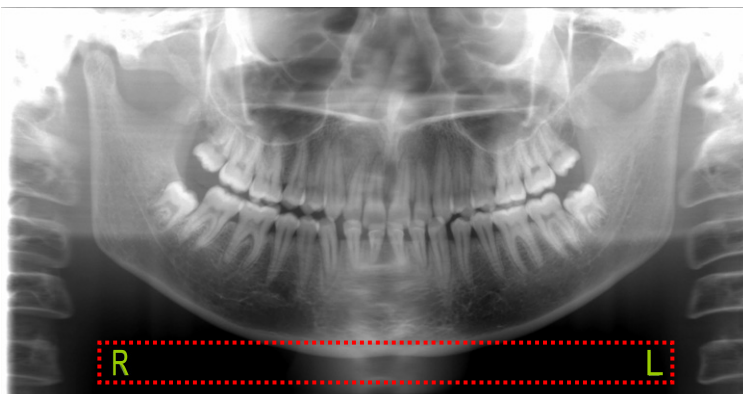

Erase objects

Described below is the procedure for erasing the objects added upon the 2D images.

Example: Erase length measurement

1. Click this button ().
2. Click the object (length measurement) you wish to erase.

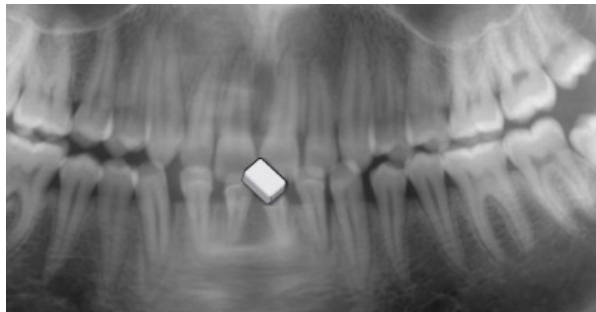
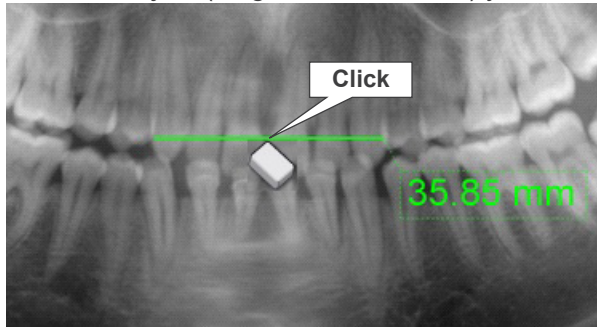

Line Profile Measurement

Drawing a line on the image to display a line chart to show the density value on the line.

1. Click the line profile button ().
2. Draw a line by left-clicking the starting point then moving the mouse and left-clicking the end point.

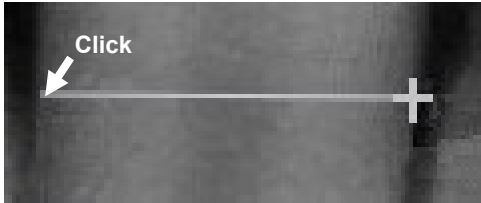

3. Click the line.
The density value along the line will be displayed on a line chart.

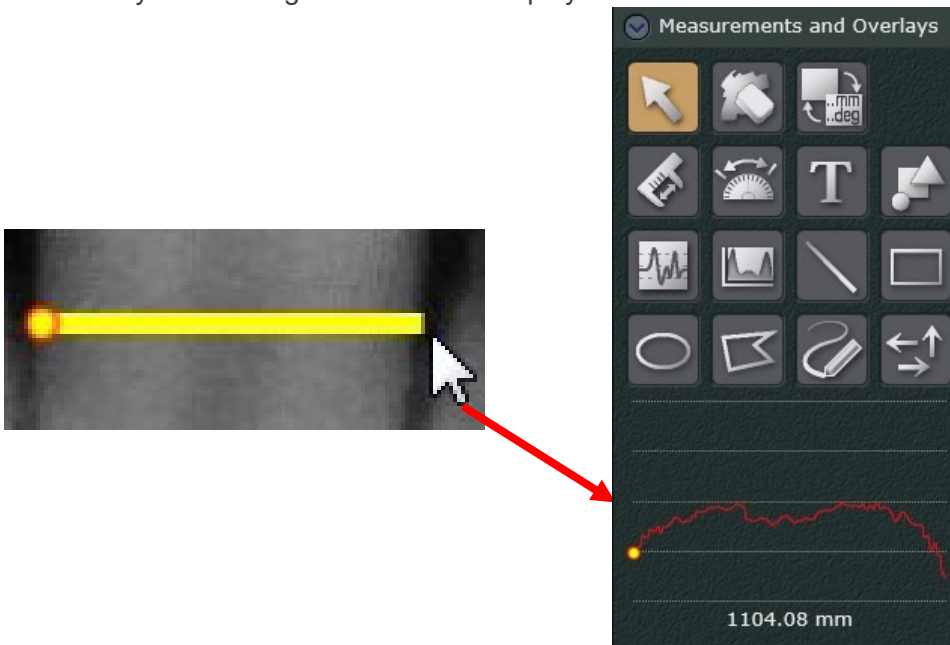

When clicking a part of the line chart, the corresponding position in the line will be displayed with a small circle. You can see which pixel indicates that density value.

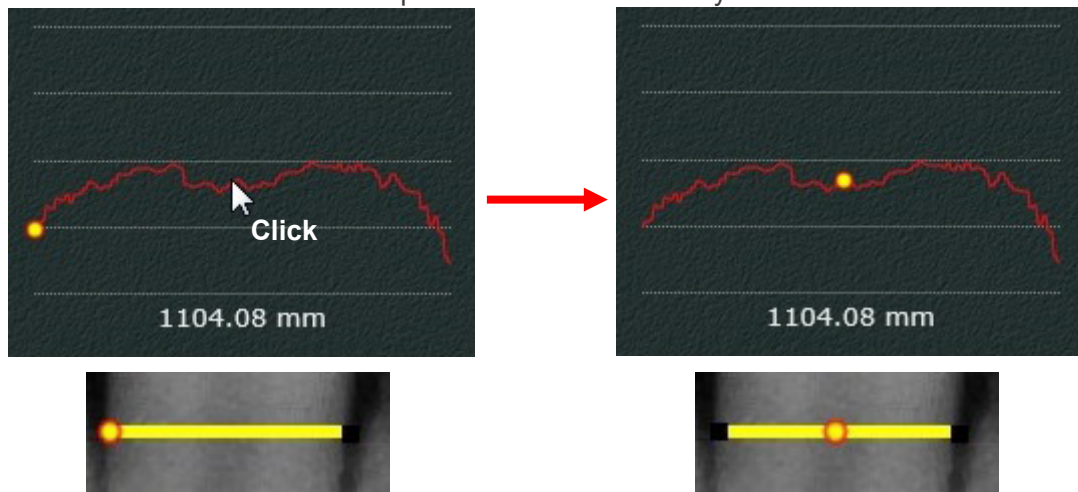

Area Profile Measurement

Drawing a rectangle on the image to measure the density of minimum, maximum, and average density values, as well as the standard deviation of the density of inside the area.

1. Click the area profile button .
2. Draw a rectangle by left-clicking the starting corner then moving the mouse and left-clicking the ending corner.

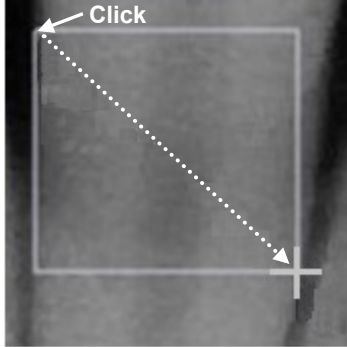

3. Click the rectangle shape.
The density of minimum, maximum, and average density values, as well as the standard deviation of the density of inside the area will be displayed.

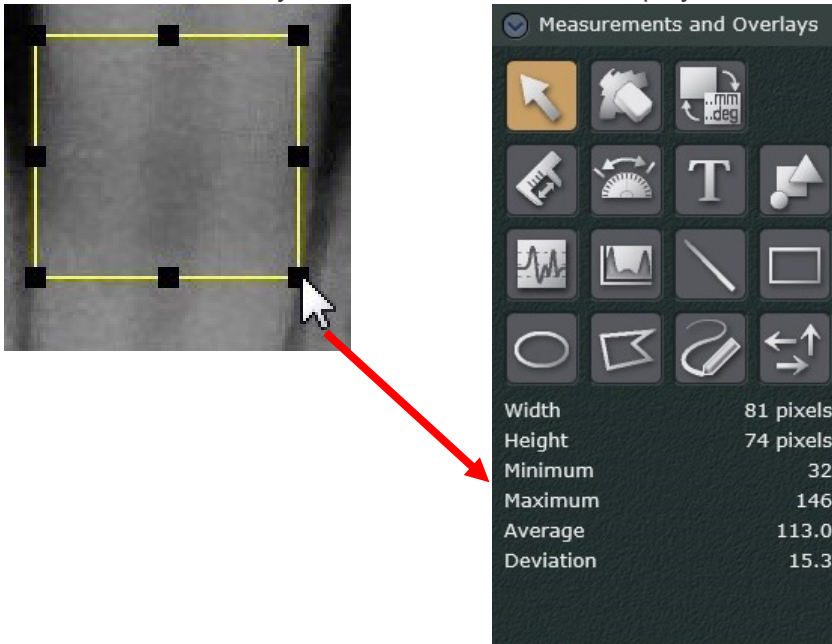

Measurements and Overlays

Width	81 pixels
Height	74 pixels
Minimum	32
Maximum	146
Average	113.0
Deviation	15.3

10.7. Part

The position and tooth number in each image can be set.

You can see which part and tooth number are set for the image. Also you can cancel these settings.

Click the desired position and tooth numbers. Clicked parts will be highlighted and the information is added to the image.

When a highlighted part is clicked, it will return to the normal color and the setting is canceled.

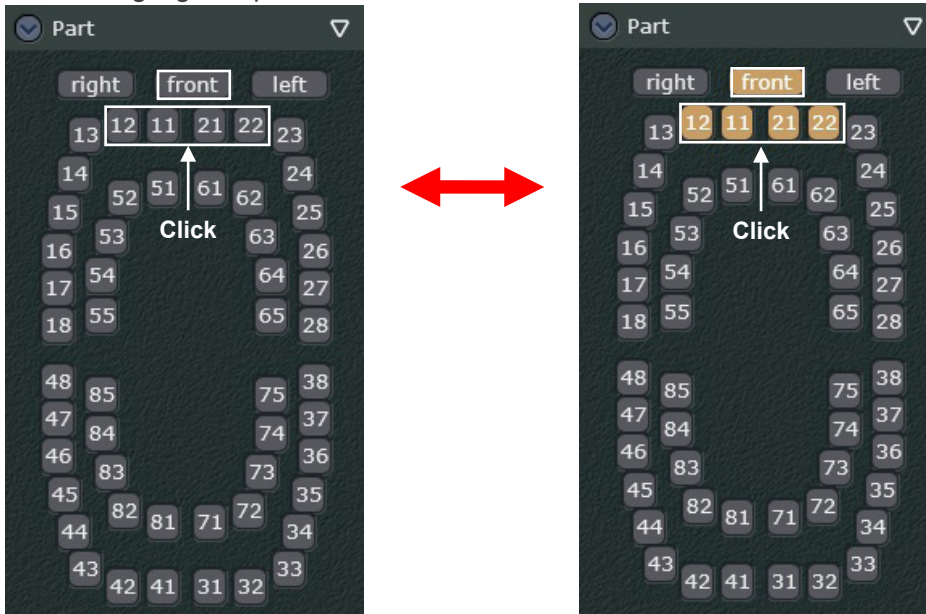

Clicking the triangle button (▾) will show the submenu.

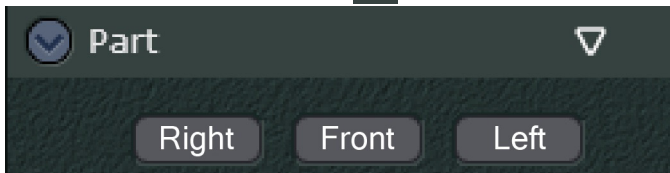

Select "Dentition" or cancel the selection to change the display item.

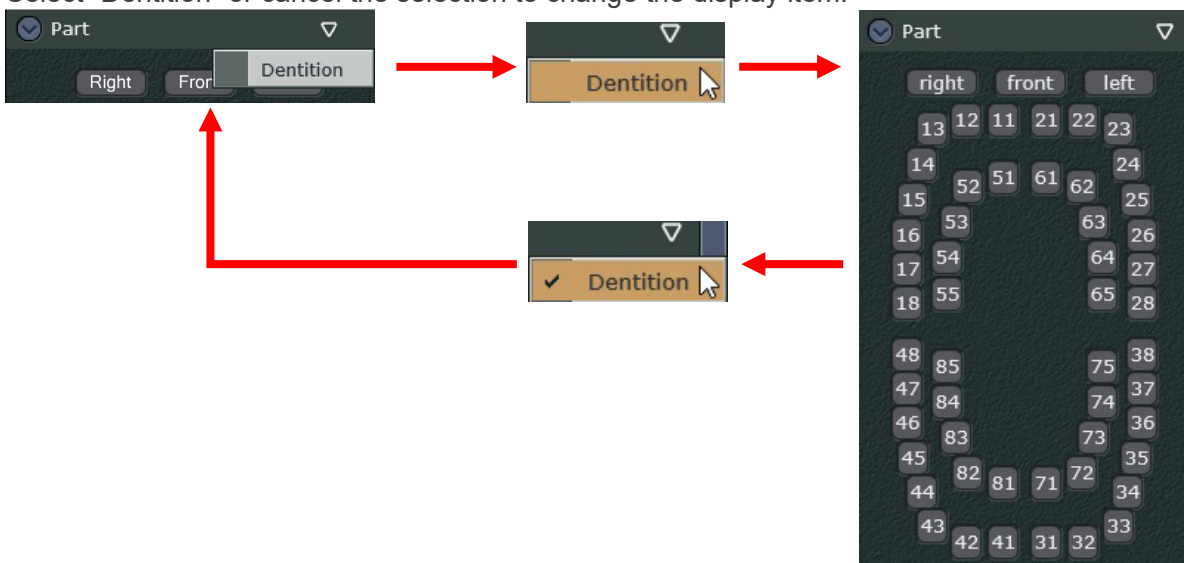

10.8. Comment

Add a comment. Comments can be edited later.

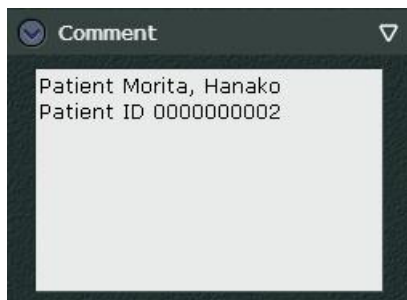

The Triangle button (▾)

Clicking the Triangle (▾) in the upper right corner will let you choose the size of the comment box.

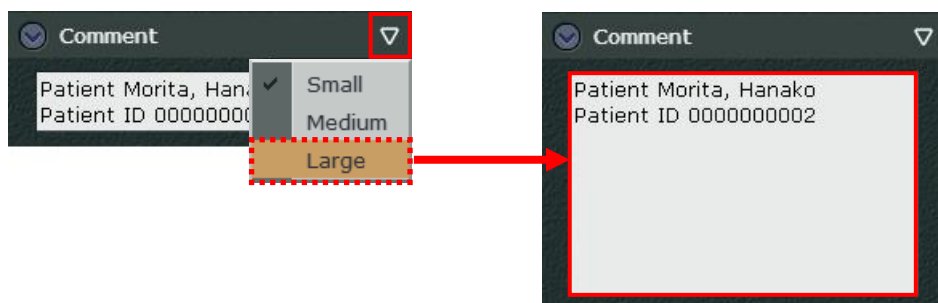

10.9. Additional Information

Display additional information for the image.

Additional information includes exposure conditions, pixel size etc.

This is useful for checking the resolution.

If no additional information is available, nothing will appear.

The additional information available depends on the model of the X-ray unit, etc.

Use the scroll bar to move the display up and down.

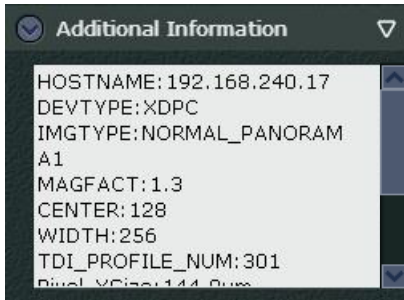

You can also simply drag the display up or down.

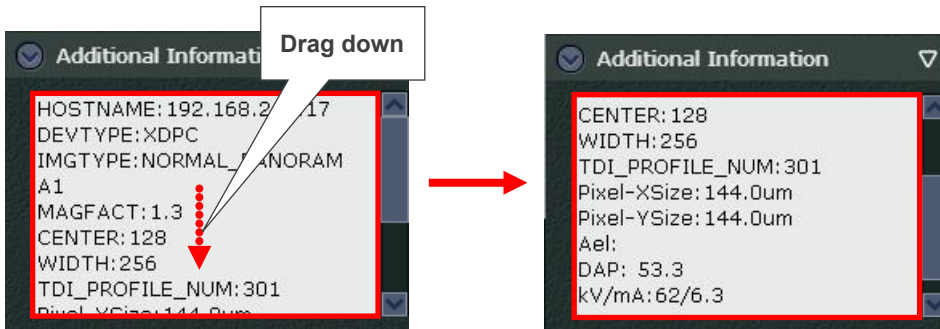

You can also use the Up (↑) and Down (↓) keys on the keyboard to view the display.

- * When making an exposure with Morita's X-ray devices., additional information is transmitted to the i-Dixel server computer and saved in the patient database.

The Triangle button (▾)

Clicking the Triangle (▾) in the upper right corner to change the size of the box for the additional information.

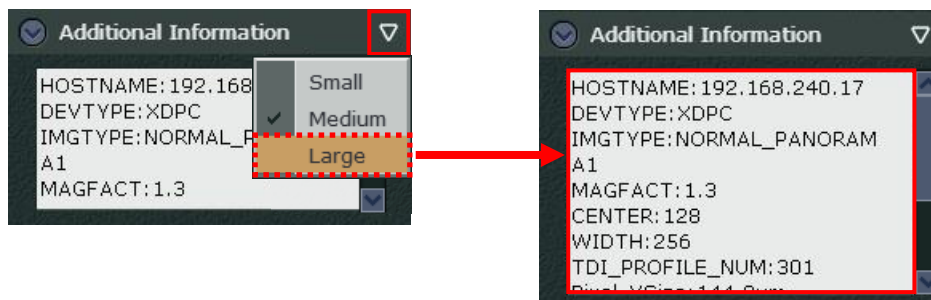

10.10. Rotate

Rotate or flip the image.



CAUTION

- *If an image has any object written on it, the buttons for image rotation with line, 90° clockwise, and 90° counterclockwise will not be active and will be grayed out.*
- *When rotating or flipping the panoramic scout image, a CT exposure position that has been configured in the panoramic scout setting will be misaligned.*



Press this button to rotate the image 90° clockwise.



Press this button to rotate the image 90° counterclockwise.



Press this button to flip the image right and left sides (mirror image)

CAUTION

- *If you flip the image, the Flip button will be highlighted. The setting of this button is especially critical when viewing panorama images. Always check the setting of this button to make sure you do not mix up the right and left sides.*



Press this button to flip the image vertically.



Press this button to rotate the image 0.5° counterclockwise.



Press this button to rotate the image 0.5° clockwise.



Press this button and draw a line for the rotation axis and the image will be rotated to adjust the tilt of the image.

See "Image Rotation with Line" (p. 99).

Image Rotation with Line

Click this button and draw a line for the rotation axis and the image will be rotated to adjust the tilt of the image.

1. Click the Line Rotation button ()
2. Draw a line by left-clicking the starting point then moving the mouse and left-clicking the end point.

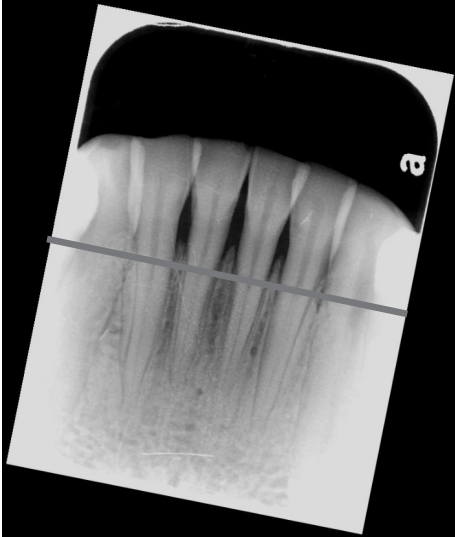

3. When you click the second point, the image will rotate so that the line will be horizontal. The dotted line on the lower right image is an explanation. The actual image does not show the dotted line.

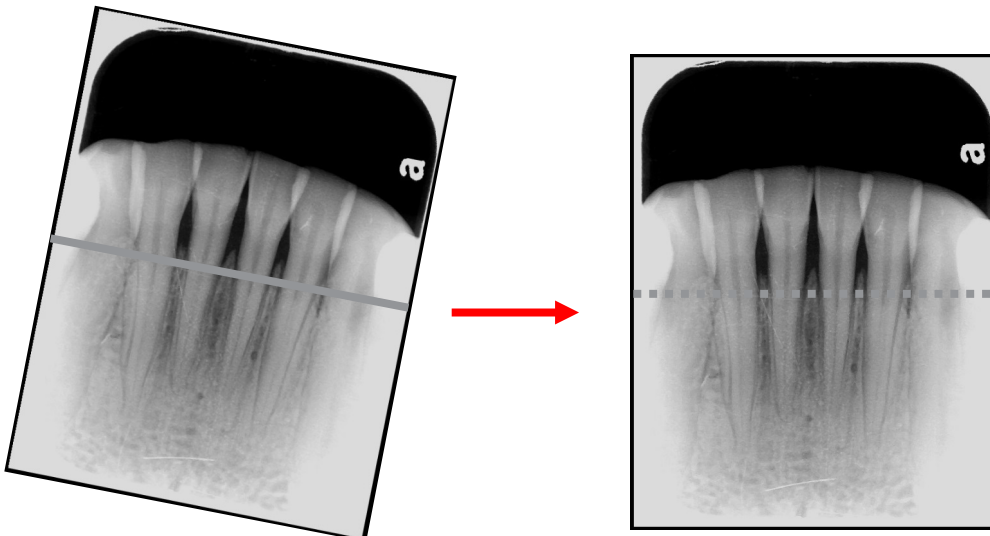

* To revert the rotation, click the highlighted Line Rotation button () again.

10.11. Crop

An image can be cropped with these buttons.



⚠ CAUTION

- *Only images with modalities “OtherImage” or “Camera” can be cropped.*



Click this button to crop the image.
See “Cropping Image” (p. 101).



Click this button to crop the image to a specified size.

- * Click the button to show the submenu; select the desired image size.



Cropping Image

Change the cropping position and frame size beforehand.

1. Click the Cropping button ().
2. The cropping frame (red dotted lines and black dots) will be displayed.

Drag the frame (red dotted line) to set the cropping position.

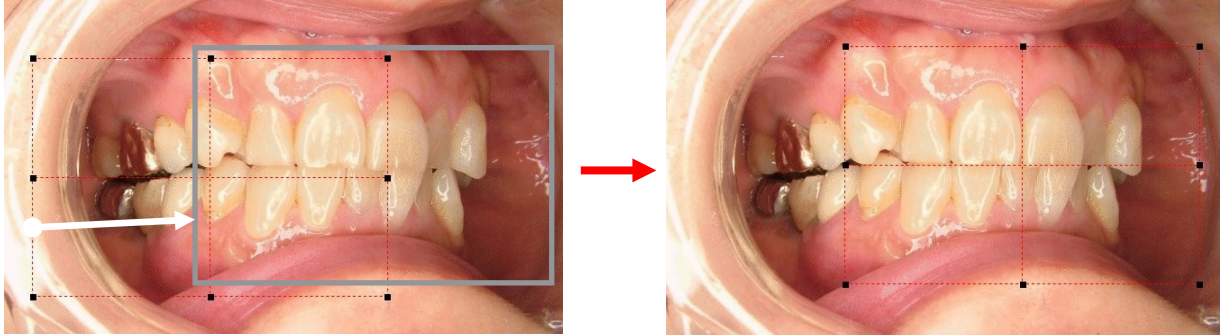

Drag the black dots to change the frame size.

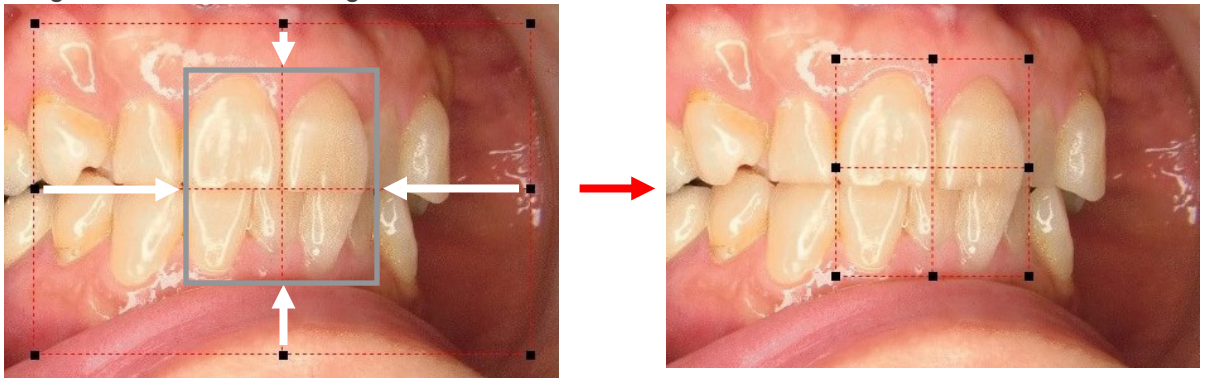

3. Double-click inside the frame to crop the image.

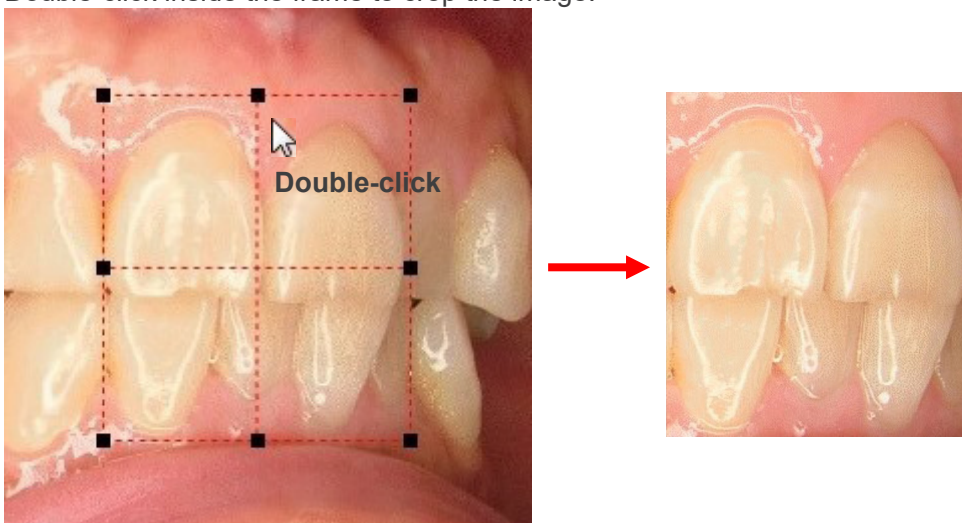

10.12. Statistics

The data listed below can be seen.

Color tone (Image type)
Horizontal and vertical size (Image width, Image height)
Minimum density (Minimum)
Maximum density (Maximum)
Average density (Average)
Standard Density Deviation (Deviation)

Statistics	
Image type	Grayscale
Image width	213.3 mm
Image height	115.7 mm
Minimum	0
Maximum	255
Average	110.8
Deviation	52.1

CAUTION

- *Images displayed by i-Dixel WEB are lossy compression JPEG versions of the original. The above image properties are for these images and may not necessarily be the same as the original versions. The original images are saved in the database on i-Dixel server.*

11. Edit CT Slice Images

Follow the instructions on “2.2.1. 2D Viewer”, “CT Slice Images” (p. 16) to display a CT slice image in the 2D Viewer. Tools available for editing are shown in the tool panel. When the 2D Viewer is displayed, the title bar and other information will appear. For details, see “2.2. Main Page” (p. 5).

⚠ CAUTION

- *Using the Back button on the web browser to return to the 2D viewer may bring up some other display*

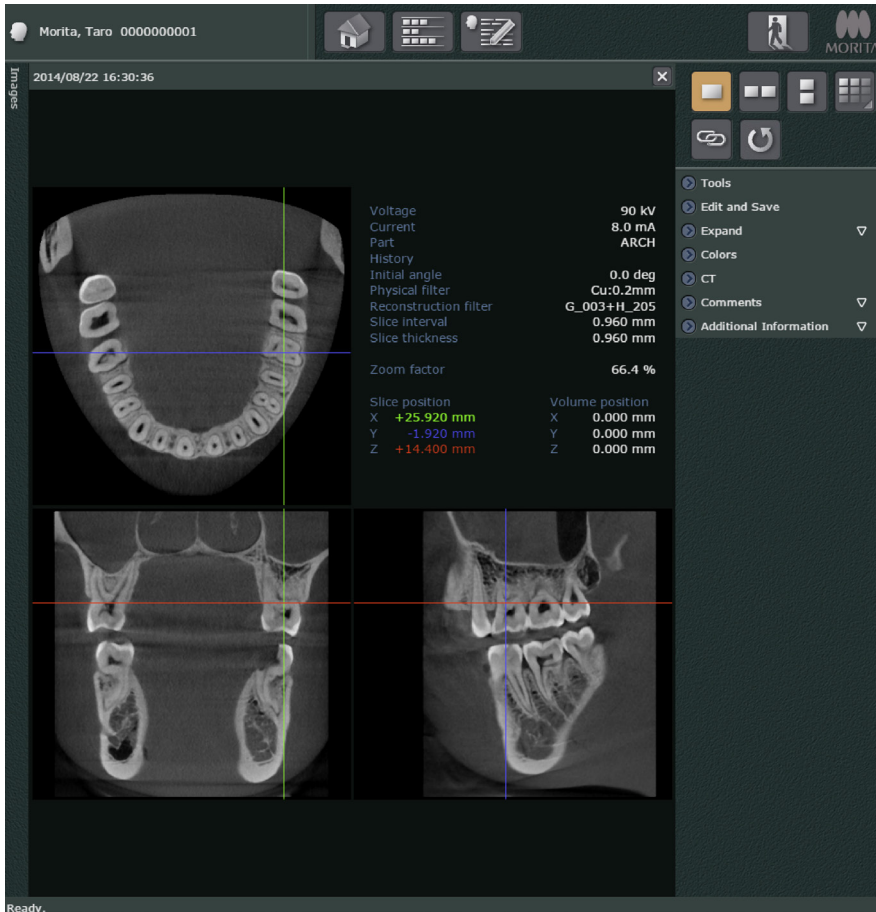

- * See “2.2. Main Page” (p. 5) for information about the toolbox.
- * Image search field and image list field are shown or hidden at the same time. For details see “Image List” (p. 8).

Change CT Slice Images

X, Y, and Z cursor lines appear on the slice image. Drag these lines to change the CT slice images.

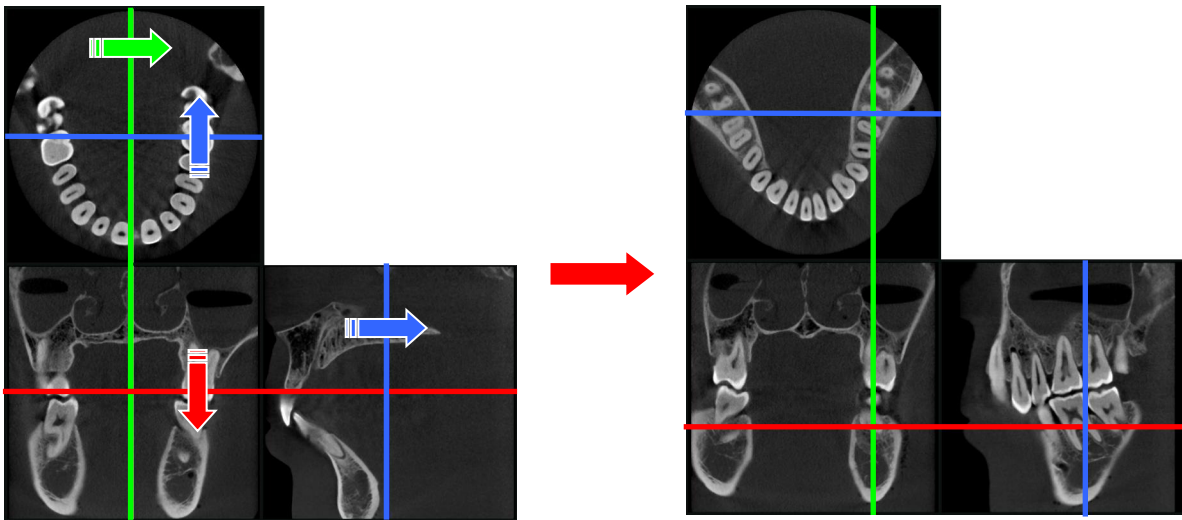

Display Additional Information

Additional information is displayed along with the CT slice image, as shown in the chart below.

Attribute Information Name	Details
Voltage / Current / Part	The settings used for scanning are displayed.
“History”	The rotation axes and angles used for re-slicing to create the CT slice data are displayed.
“Initial angle”	The initial angle specified for reconstruction is displayed.
“Physical filter / Reconstruction filter”	The settings used for scanning are displayed.
“Slice interval / Slice thickness”	The settings used for creating the CT slice data are displayed.
“Zoom factor”	The current magnification is displayed.
“Slice position”	The position of the currently displayed slice image is displayed with the center of the volume data as the origin.
“Volume position”	The center position of the currently displayed slice image is displayed with the center of the imaging area as the origin.

* If there is no information, the field will be left blank, or “___” will be displayed.

Single Display of CT Slice Image

When you double-click one of the CT slice image, only that image will be displayed in the 2D Viewer. Also, the basket will appear

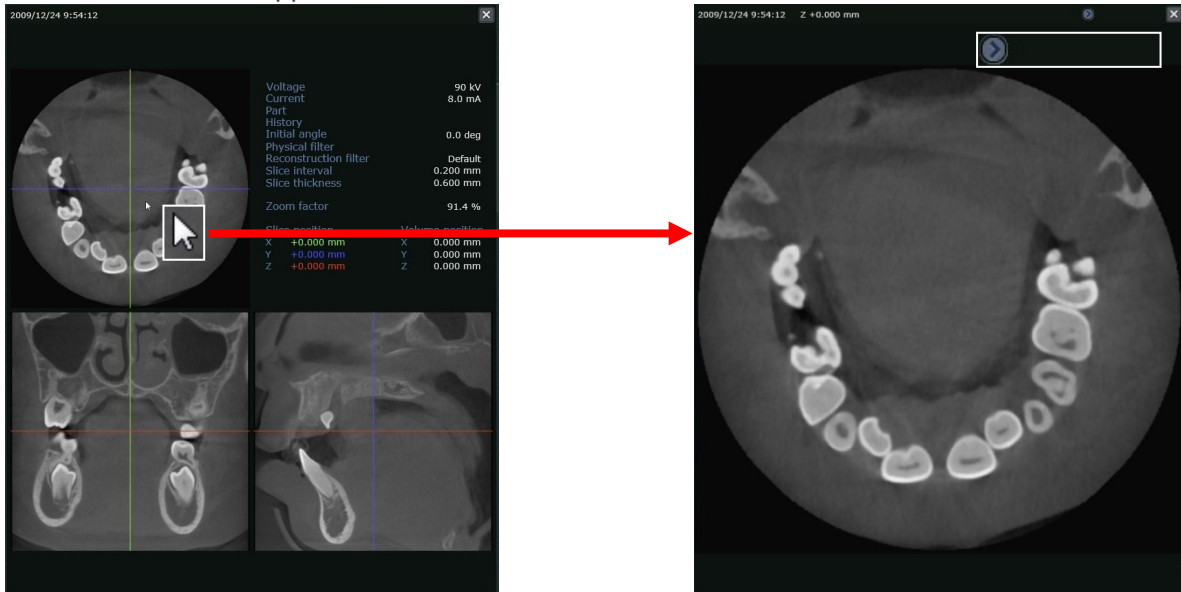

Click the thumbnail image as shown in the white frame below or the Close button (X) to return to the normal view.

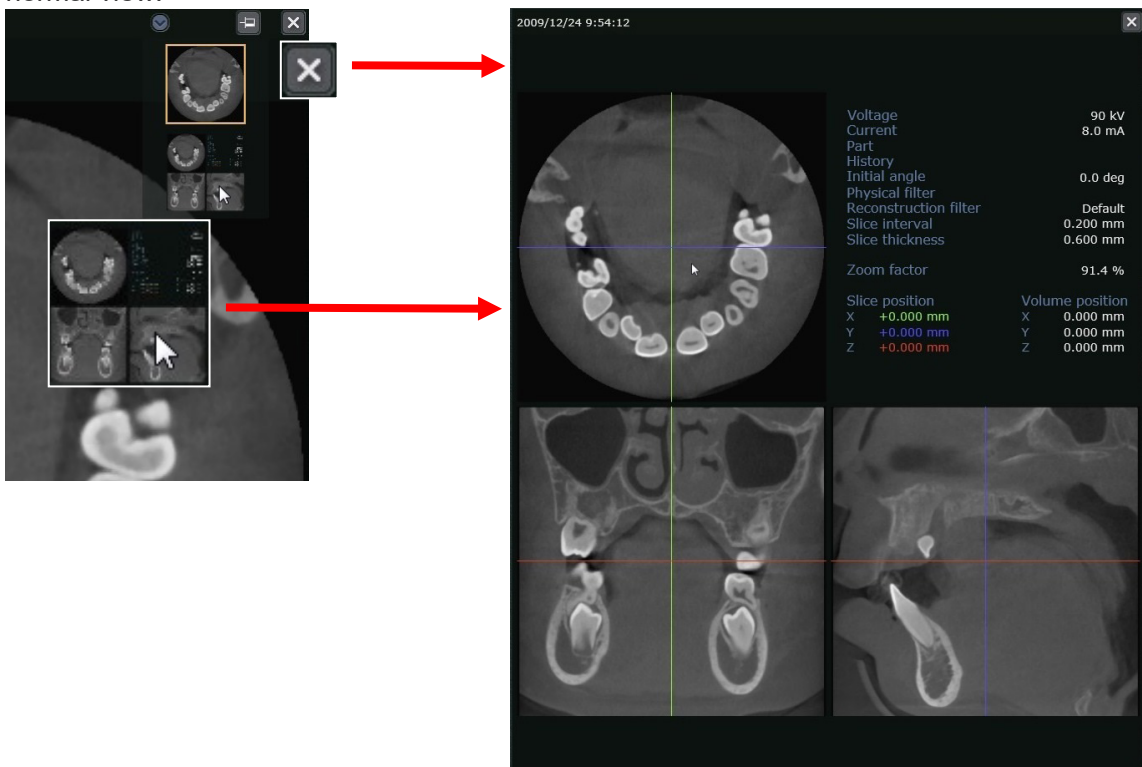

Display CT Annotation Image (Slices with Annotations)

If a CT slice image which has been overlaid with text or symbol objects is displayed in the 2D Viewer, "Slices with Annotations" will appear.



When you select a value from the drop-down list, the displayed image will be changed to the corresponding CT slice image with the object. Each value in the drop-down list represents a slice position of the CT slice image that has an overlaid object.

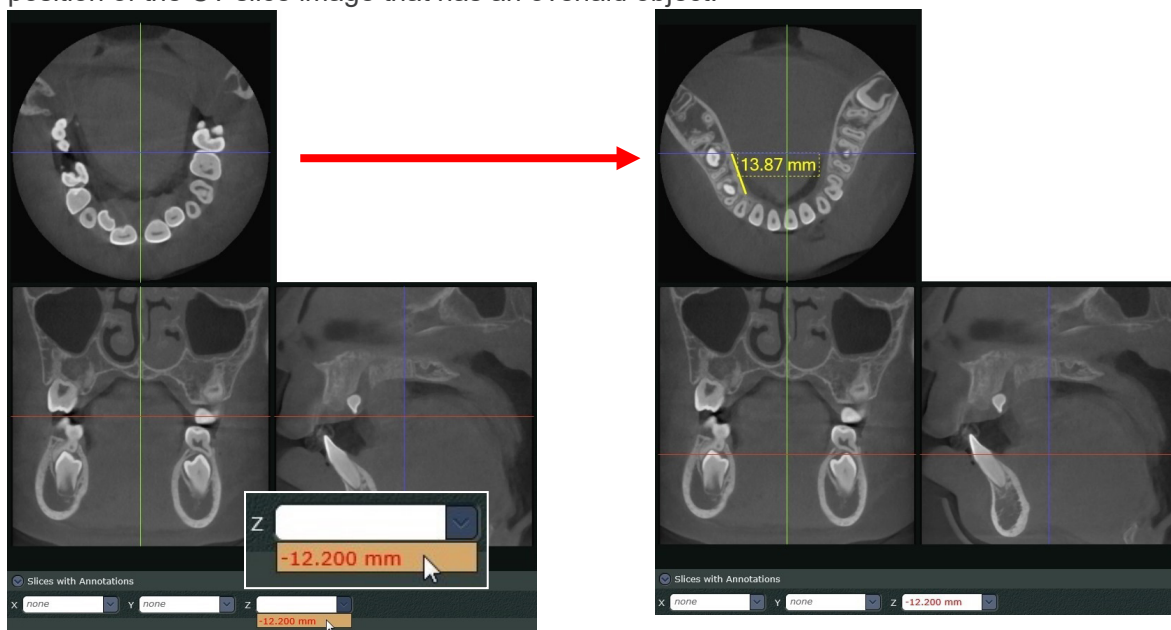

* A figure, text, symbol, or measured value for distance or angle is described as an object in this manual. Moreover, a CT slice image overlaid with an object is described as a CT annotation image.

11.1. Tools

It is possible to export CT data, XYZ slice images, and CT slice images.



Click the Export button to display the menu shown below.

You can use the menu indicated by 1 to export CT data or XYZ slice images. CT slice images will be exported in DICOM format when selecting menu choices marked as 2. CT slice images will be transferred to PACS in DICOM format when selecting menu choices marked as 3.

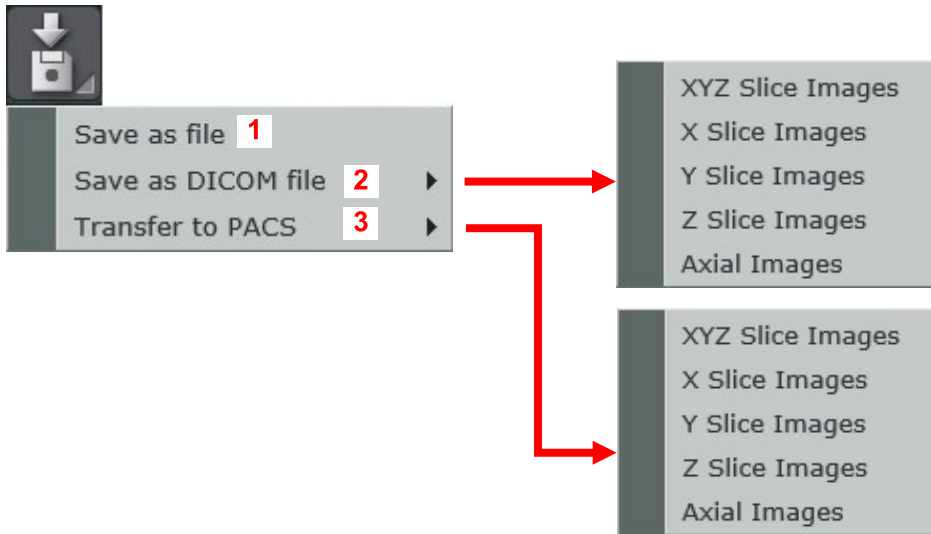

* This operation also can be made by right-clicking the CT slice image in the image list to show the shortcut menu.

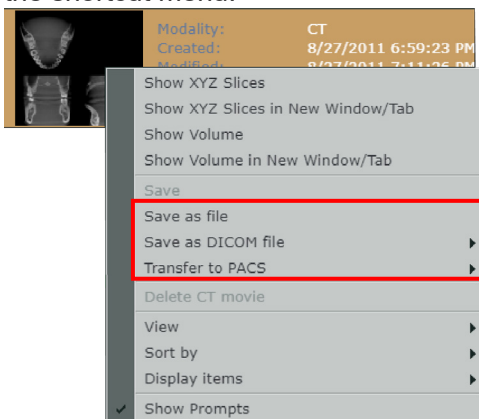

* The XYZ slice images are exported as per the thumbnail of the CT data displayed in the image list. The exported file is a single 2D image.

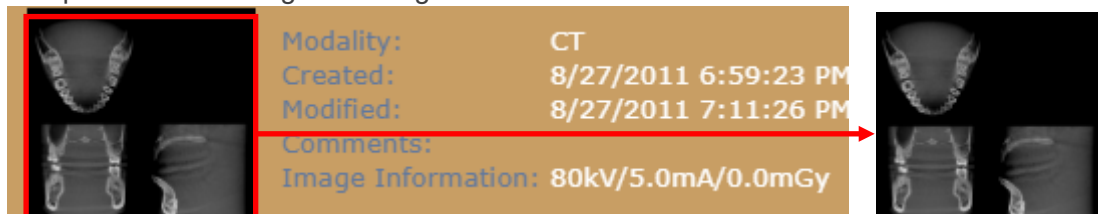

Export CT Data

Follow the procedures below to export CT data.

Data will be exported to the download file destination specified by the web browser.

CT data will be compressed to a ZIP folder and exported.

You can export various kind of CT data, such as CT raw data, CT volume data, and CT slice data.

CT Raw Data: CT volume data can be generated from raw data.

CT Volume Data: It is generated from CT raw data, and is used for displaying a volume rendered image.

CT Slice Data: It is generated from CT volume data, and is used for displaying CT slice images.

1. Click the Export button under Tools on the Main Panel, then select "Save as file".



2. A dialogue box below will appear. Select "CT Data" from the Export type field.

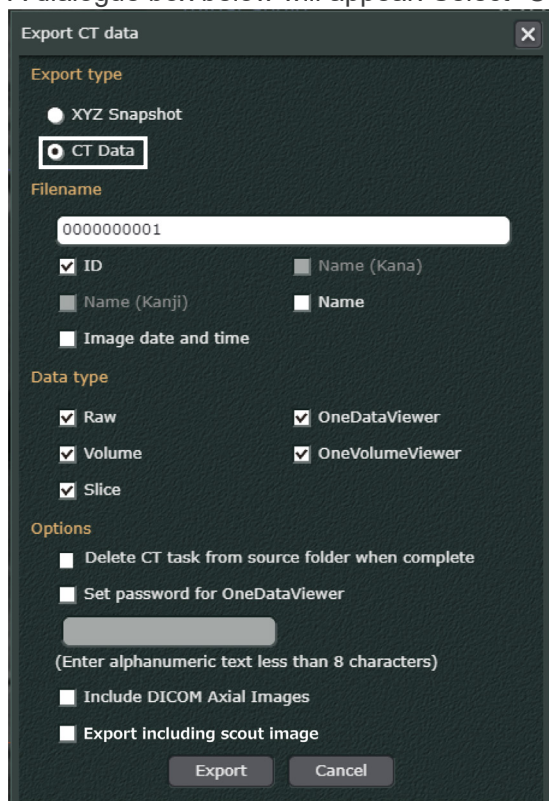

3. Set desired ZIP file name in the Filename field.
You can set the file name by selecting "ID", "Name", and "Image data and time".

4. Select desired CT data from the Data type field.

- * When selecting "Volume", "OneVolumeViewer" can be selected to display volume rendered image in One Volume Viewer.
- * When you select "Slice", "OneDataViewer" can be selected to display CT slice images in One Data Viewer.

5. Set the Options field as necessary.

- **Delete CT Task from source folder when complete**

After exporting the data, its CT task will be deleted.
However, it is necessary to select “Raw” in the Data type field.

* CT Task is the aggregated data of CT raw data, CT volume data, and various others.
It is saved in the i-Dixel server capture computer or the i-Dixel capture computer.

- **Set password for OneDataViewer**

Select this option to set the password for displaying CT slice images in the One Data Viewer.

- **Include DICOM Axial Images**

Select this option to export axial images in the DICOM format according to the data selected in “Data Type”.

The dialog box to set the slice interval and thickness will appear as explained in “Export CT Slice Images in DICOM Format” (p. 111).

The Accession Number setting dialog may also be displayed.

- **Export including scout image**

Scout images can be exported only if CT data linked to the scout image is exported.
The “+” marks that are used to indicate scout positions are exported together with scout images.

* For more information about scout images and scout positions, refer to the instructions for use of the CT scanner used for scout radiography.

6. Click the “Export” button.

[Export XYZ Slice Images]

The XYZ slice images are the 2D images exported as per the thumbnail of the CT data displayed in the image list.

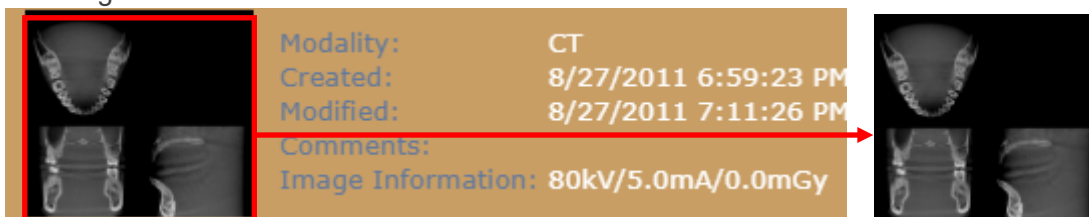

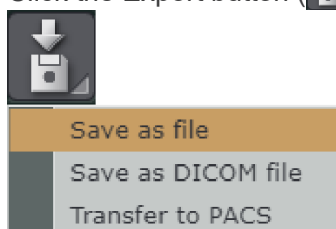

Follow the steps below to export the XYZ slice images.

1. Click the Export button () in “Tools” in the 2D Viewer, and select “Save as file”.

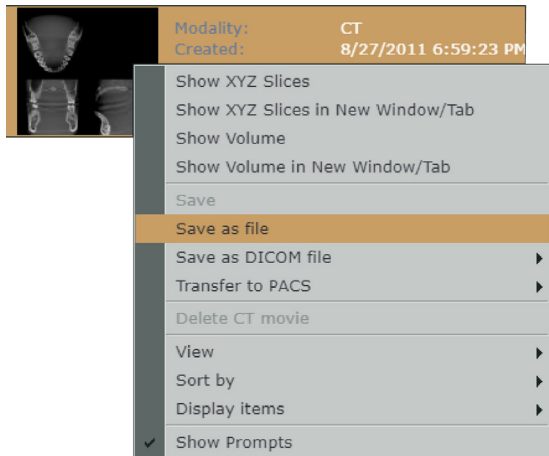

Or, right-click on the thumbnail in the image list and select “Save as file”.



2. The following dialog is displayed. Select “XYZ Snapshot” in “Export type”, and click the “Export” button ().

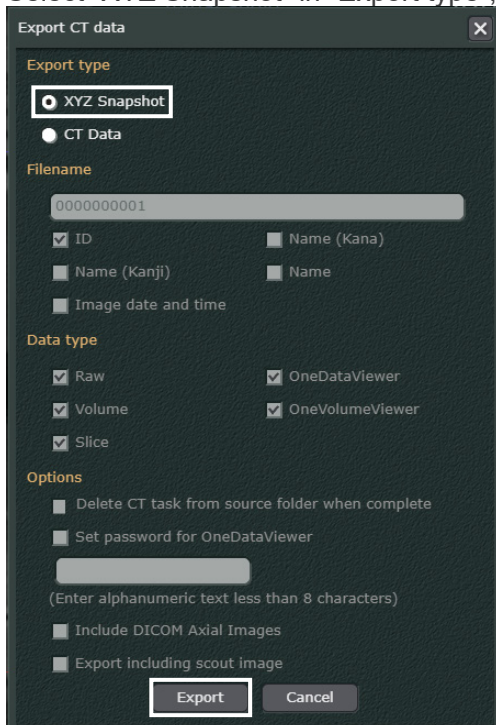

3. The following dialog is displayed. Select the file format of the XYZ slice image to be exported.

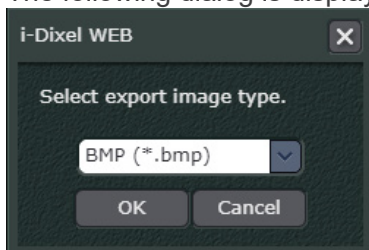

4. The XYZ slice image is compressed to ZIP format and exported to the download destination folder set in the Web browser. An image information text file is included and exported along with the downloaded image.

Export CT Slice Images in DICOM Format

CT slice images can be exported in DICOM Format.
Individual slices can be selected for export.

Data will be exported to the download file destination specified by the web browser.

- * When exporting, the “Accession Number” may be requested.

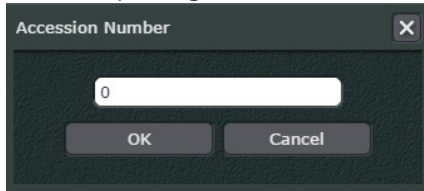

A dialog box titled "Accession Number" with a close button (X) in the top right corner. It features a text input field containing the number "0". Below the input field are two buttons: "OK" and "Cancel".

Select “Save as DICOM file Axial Image” to export the Z slice images as axial images that reflected the patient direction (posture) during the CT exposure.

When you select “Save as DICOM file Axial Image” from the Main Panel, the following dialogue box will appear to set the slice interval and thickness. When clicking the OK button, CT volume data will be re-sliced and then axial images will be exported.



A dialog box titled "i-Dixel WEB" with a close button (X) in the top right corner. It contains two rows of settings: "Interval" with a dropdown menu set to "0.250" and "mm" to its right, and "Thickness" with a dropdown menu set to "0.500" and "mm" to its right. At the bottom are "OK" and "Cancel" buttons.

Transport CT Slice Images in DICOM Format

CT slice images can be transported to PACS in DICOM format.
Individual slices can be selected for export.

- * When transferring, the “Accession Number” may be requested.

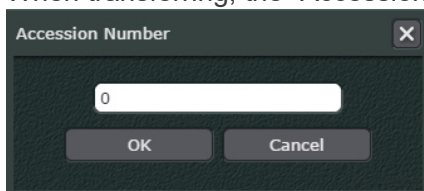

A dialog box titled "Accession Number" with a close button (X) in the top right corner. It features a text input field containing the number "0". Below the input field are two buttons: "OK" and "Cancel".

Select “PACS DICOM file Axial Image” to transport the Z slice images to PACS as axial image.
Those images reflect the patient direction (posture) during the CT exposure.

When you select “PACS DICOM file Axial Image” from the Main Panel, the following dialogue box will appear to set the slice interval and thickness. When clicking the OK button, CT volume data will be re-sliced and then axial images will be exported.



A dialog box titled "i-Dixel WEB" with a close button (X) in the top right corner. It contains two rows of settings: "Interval" with a dropdown menu set to "0.250" and "mm" to its right, and "Thickness" with a dropdown menu set to "0.500" and "mm" to its right. At the bottom are "OK" and "Cancel" buttons.

11.2. Save and Edit

Save a new, edited version of the image.

You can also go back to previous versions and forward to later versions.



For details about how these buttons work, see "10.2. Edit and Save" (p. 60).

11.3. Expand

Enlarge or Shrink Image. This is the same as for 2D images.

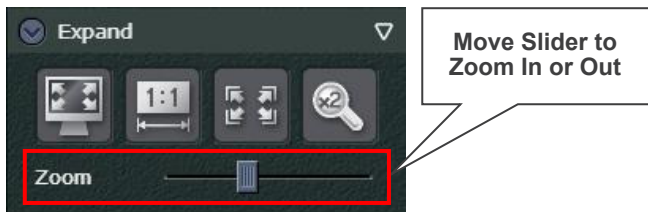

For details about how these buttons work, see "10.3. Expand" (p. 64).

11.4. Colors

Adjust brightness and contrast as for 2D images

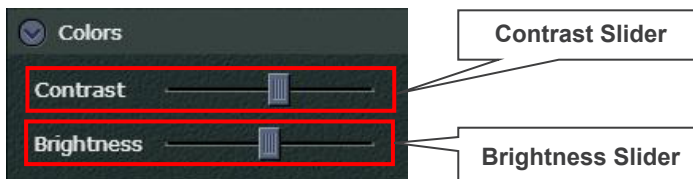

- * Contrast can be adjusted by moving the mouse sideways with right-click and holding the image.
- * Brightness can be adjusted by moving the mouse up and down with right-click and holding the image.

11.5. CT

Switch slice positions, hide or show X, Y, and Z cursor lines, and show list of slices



Switch position of X slice image.



Switch position of Z slice image.



Show or hide cursor lines for X, Y, and Z slice images.



Show a list of slice images.

See below for how to “Display a Slice List” (p. 114).

See the next page for how to “Display a Single Slice” (p. 115).

Display a Slice List

Click this button ().

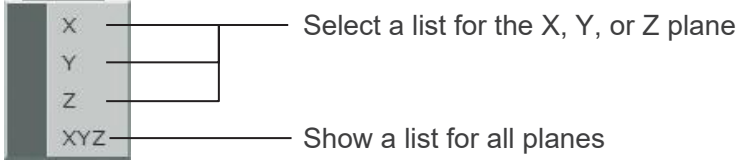

If you select Z, a list of Z slices will appear.

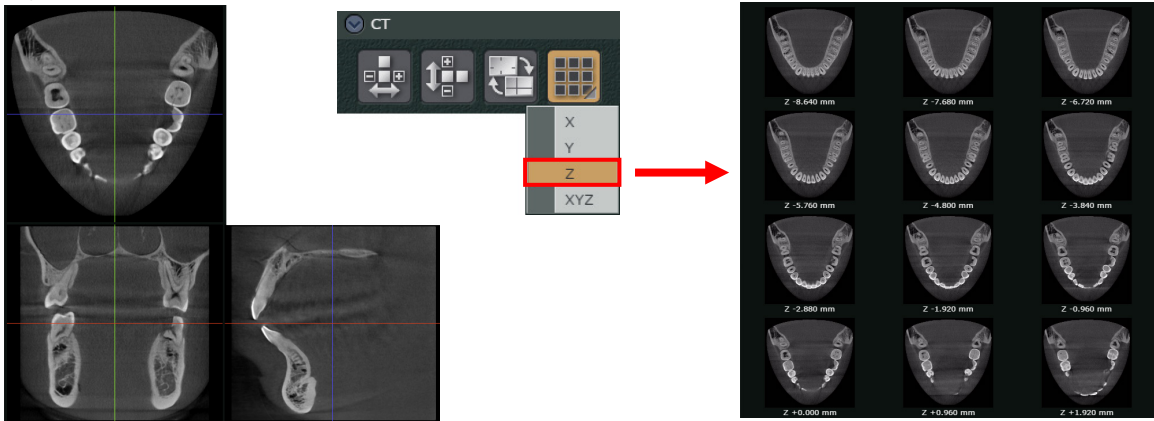

Click this button () again to return to the regular display.

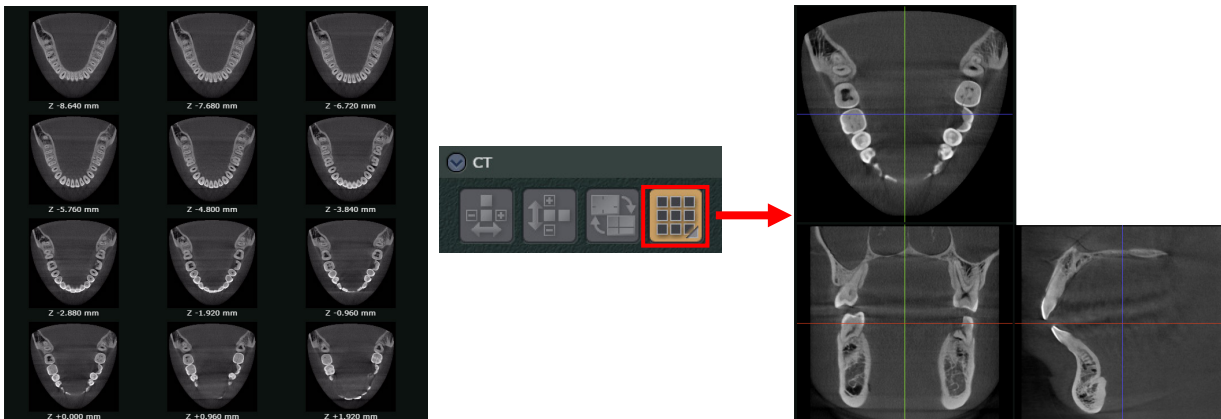

Display a Single Slice

If the thumbnail for a CT slice in the list is double-clicked, it will be displayed as a single image. The Arrow button  will also appear.

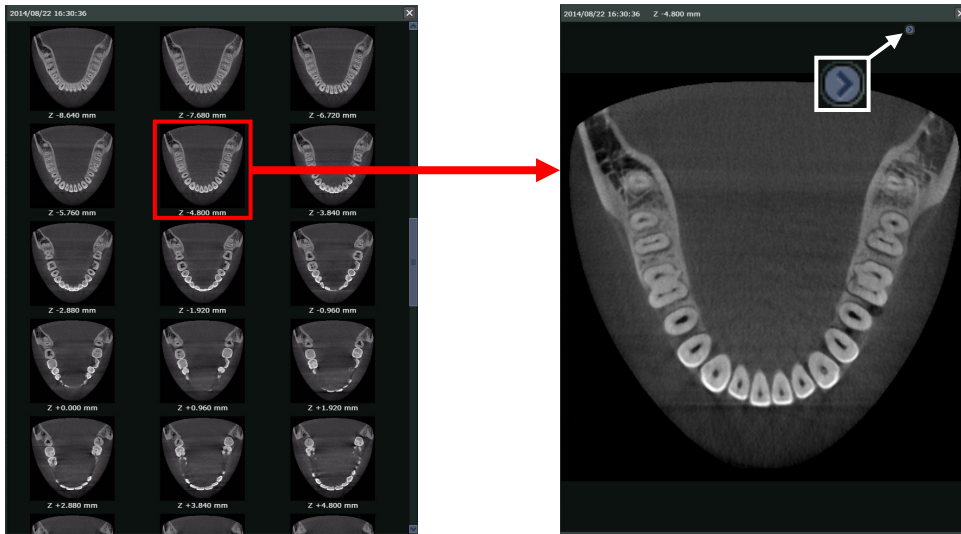

Display the basket and click the thumbnail for a CT slice. The display will return to the CT slice list.



A Symbol Displayed on CT Slice Thumbnail Image in the Image List

A symbol () displayed on a CT slice thumbnail image in the image list indicates that the image has some overlaid objects.

When you double-click the CT slice image with that symbol, the corresponding CT slice image with an overlaid object will be displayed in the 2D Viewer. Also, the basket will appear.

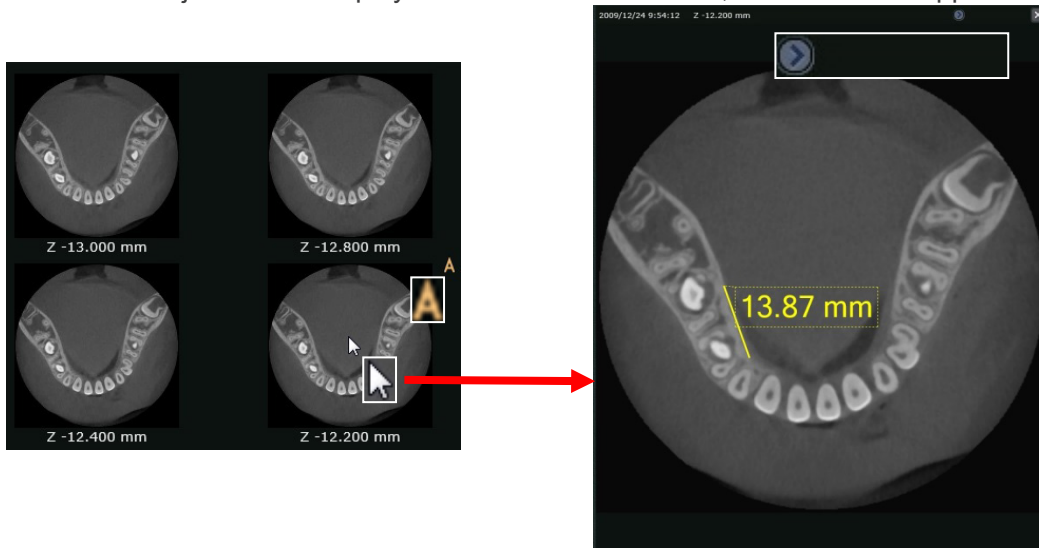

Click the thumbnail image as shown in the white frame below or the Close button (×) or to return to the normal view.

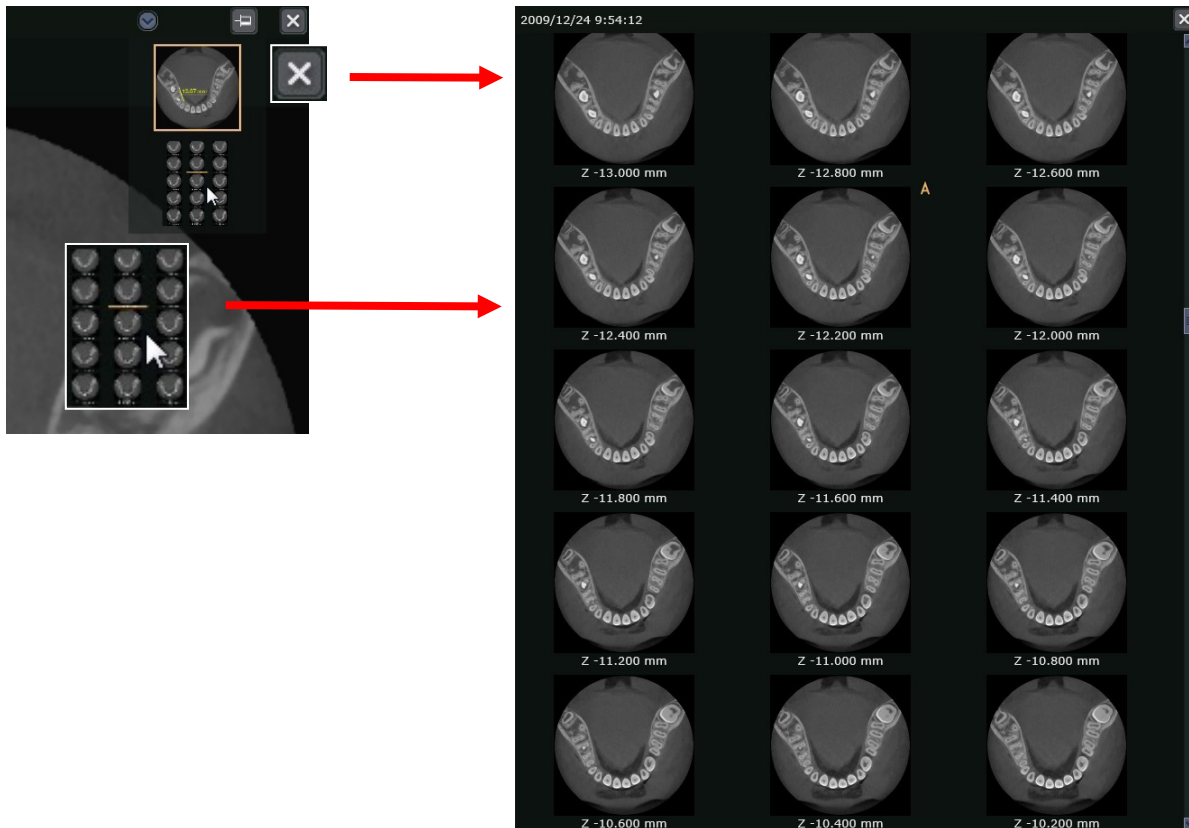

11.6. Comment

Comments can be added and edited later as for 2D images.

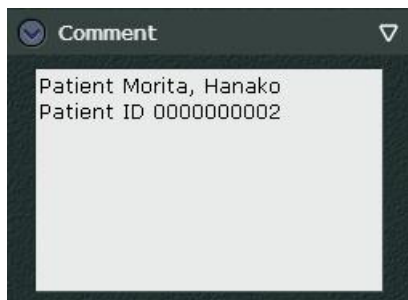

See "10.8. Comment" (p. 96).

11.7. Additional Information

Display additional information for CT slice images in the same way as for 2D images. However, additional information cannot be edited.



See "10.9. Additional Information" (p. 97).

12. Edit CT Images

See “2.2.2. 3D Viewer” (p. 19).

Select a CT image to display the volume rendered image and the slices linked to it in the 3D Viewer. The tool panel is displayed to the right of the image.

When the 3D Viewer is displayed, the title bar and other information will appear. For details, see “2.2. Main Page” (p. 5).

⚠ CAUTION

- *Using the Back button on the web browser to return to the 3D viewer may bring up some other display.*

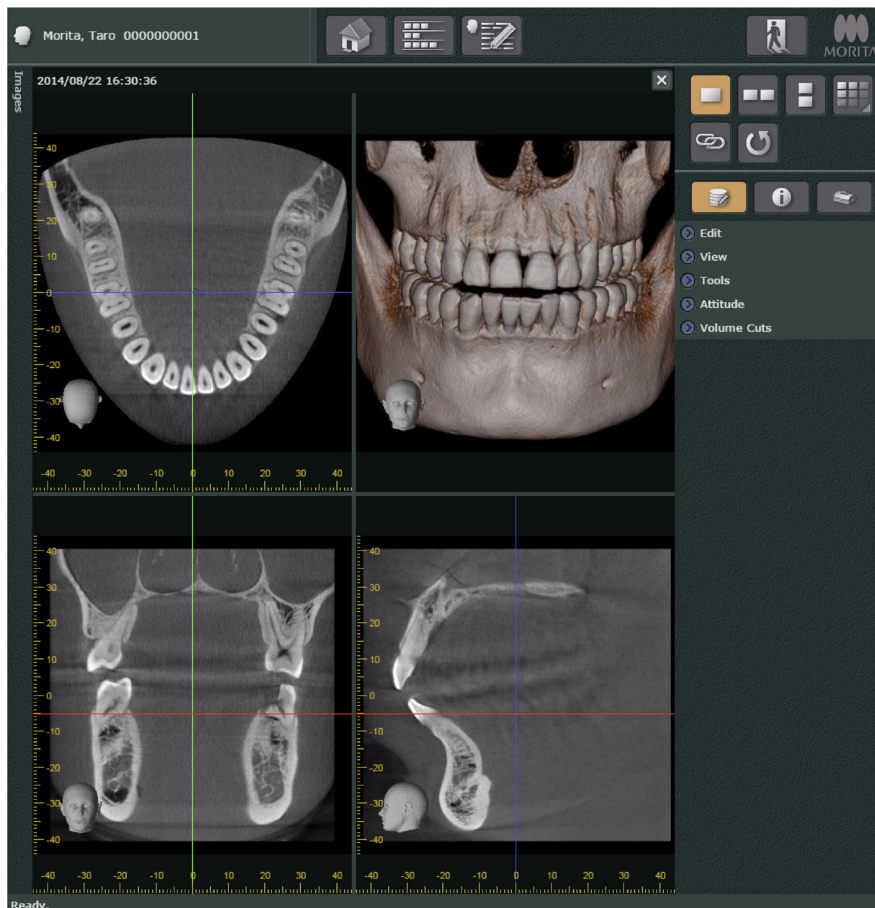

- * See “2.2. Main Page” (p. 5) for information about the toolbox.
- * Image search field and image list field are shown or hidden at the same time. For details see “Image List” (p. 8).

Images in the 3D Viewer can be changed and manipulated in various ways.

- CT slice images can be altered and rotated.
- Volume rendered images can be rotated, enlarged or shrunk, and moved.

These operations are explained below.

Clicking the buttons on the control panel will switch from the toolbox to the Main Panel, Settings Panel or Data Panel.



Uses of the Main, Data, and Settings Panel will be explained later:
See “12.1. Main Panel” (p. 123).

Change CT Slice Images

Drag the X, Y, and Z cursors to change the slice images.

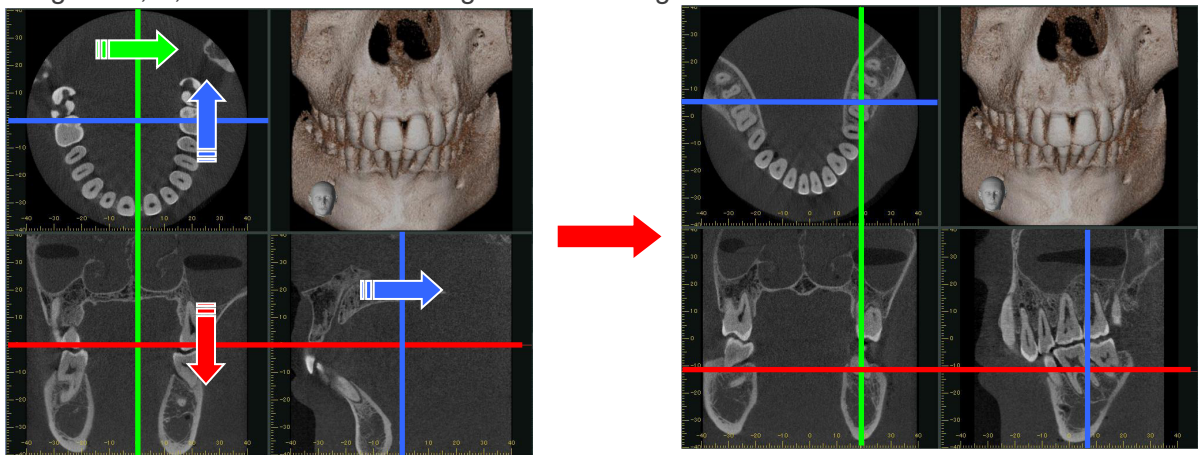

Rotate CT Slice Images

Drag on an image to rotate it to the right or left.

As shown below, dragging on the Z slice will rotate it and the X and Y slices will also change accordingly.

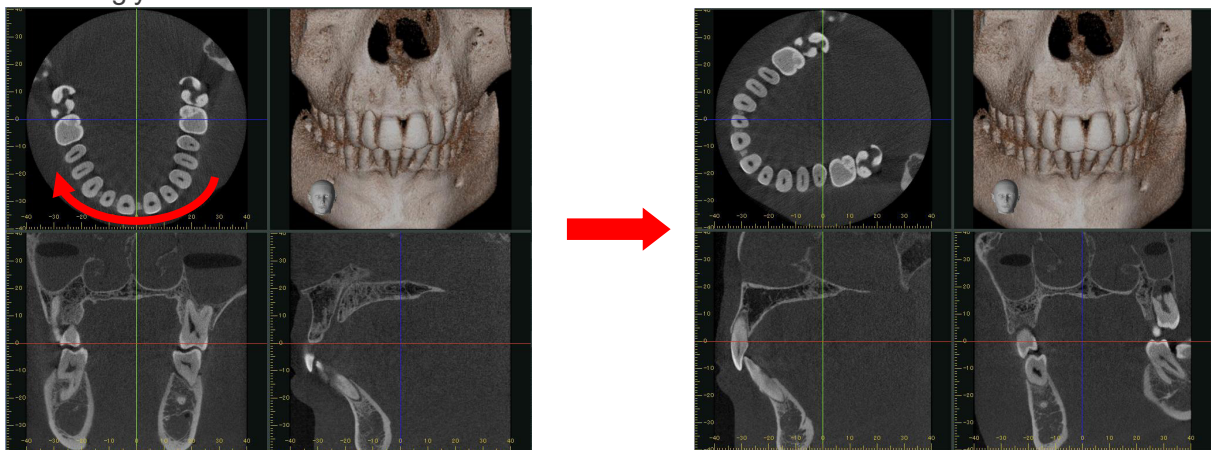

* You cannot rotate images by dragging the X, Y, or Z cursor lines. Dragging a X, Y, or Z cursor line will move the line and display a new slice.

Enlarge or Shrink CT Slice Images

You can enlarge or shrink the CT slice images displayed in the XYZ View.

Put the mouse cursor on the CT slice image and drag to the right with the Ctrl key pressed to enlarge or shrink the displayed image.

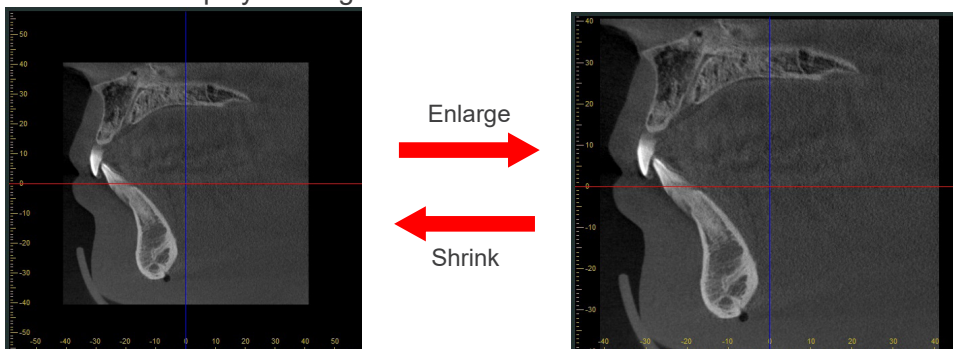

- **Enlarging**
 Images can be enlarged up to the size (maximum size) in which the CT slice image is displayed in the XYZ view for the first time after the CT volume data is selected from the image list. The size available for enlarging corresponds to the length of the display frame of the CT slice image.

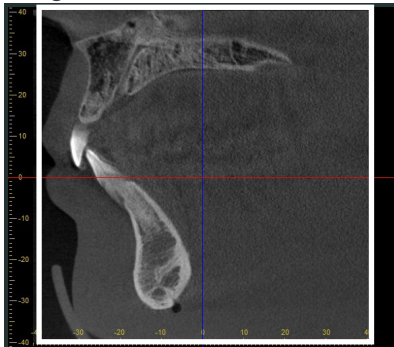

- **Shrinking**
 Images can be shrunk down to the size shown below.

Maximum size

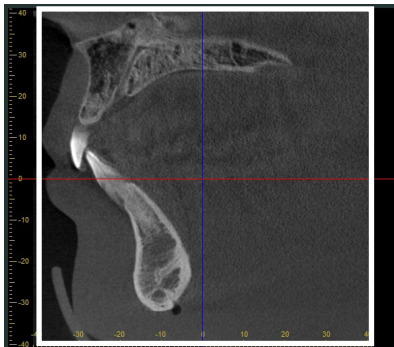

Minimum size

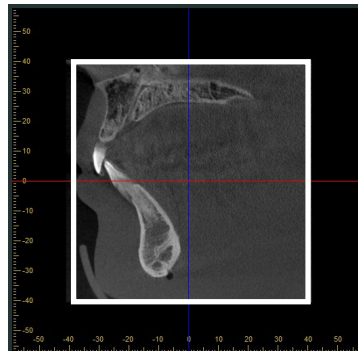

The size available for shrinking corresponds to the size where the diagonal of the minimum size is equal to the length of the display frame.

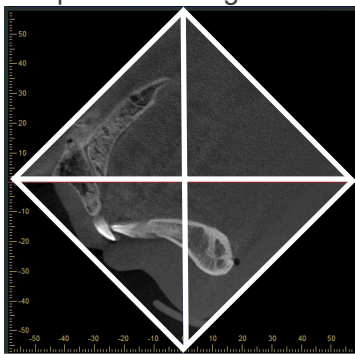

Shortcut Menu for CT Slice Images

Right-click any of the X, Y, and Z slice images to show the shortcut menu.



"Ruler Position"

Change the display position for the ruler in the X, Y, and Z slice images.

"Orientation Indicator Position"

Change the display position for the orientation indicator in the X, Y, and Z slice images.

"Thickness"

Change the slice thickness for the CT slice images.

To reduce the noise and artifacts, an increase in thickness is effective.

To examine fine anatomy, decrease thickness.

Rotate Volume Rendered Image

Drag on the image to rotate it up, down, left, or right.

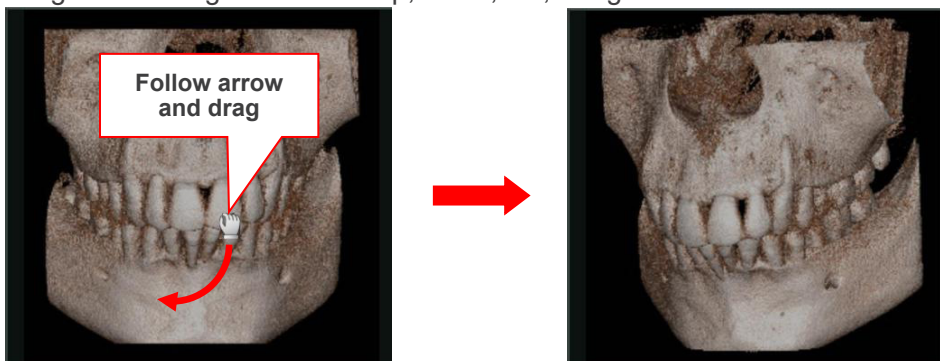

Hold down the Ctrl and drag the image clockwise or counterclockwise to rotate it.



Enlarge or Shrink Volume Rendered Images

Put the mouse cursor on the image and turn the mouse wheel to enlarge or shrink images. Turn the wheel back to enlarge the image.

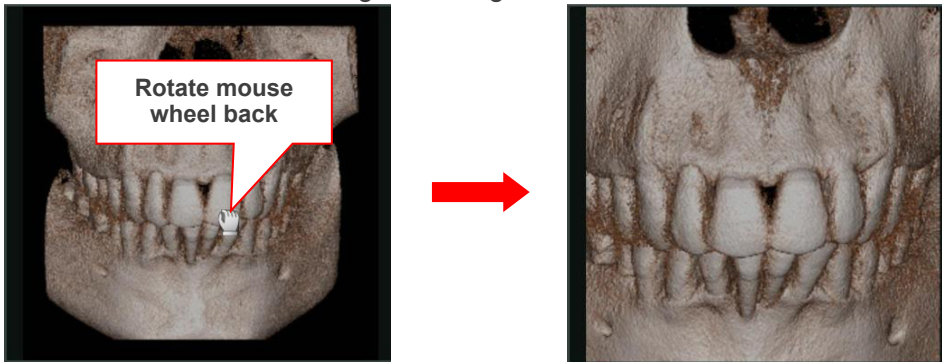

Move a Volume Rendered Image

Hold down the Shift key and drag on the image to move it up, down, left, or right.

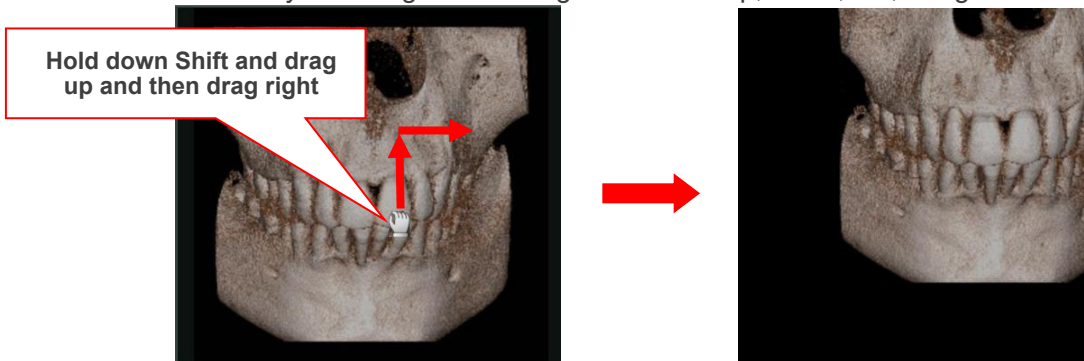

12.1. Main Panel

Used to edit and measure CT slice images and volume rendered images.
Used to produce, display and edit panoramic and cross section images.

12.1.1. Edit

After editing the images in 3D Viewer, the changes can be saved.
You can take a snapshot of the image that is currently displayed.

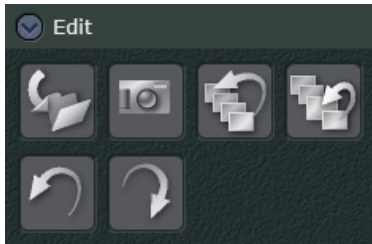

The changes for CT slice images, volume rendered images, panoramic images, and cross section images will be saved.

Click the button to display the following dialog box.
The edited content can be saved in the dataset.

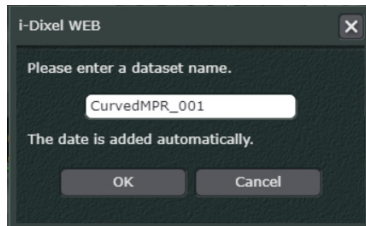

After saving, when you reselect the patient in the Home page, a thumbnail image of the saved image will be added to the image list.

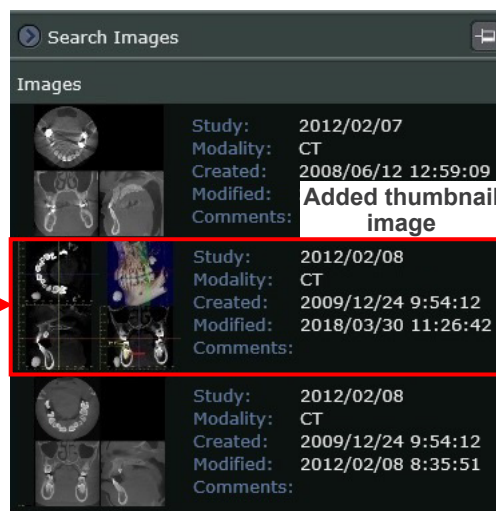
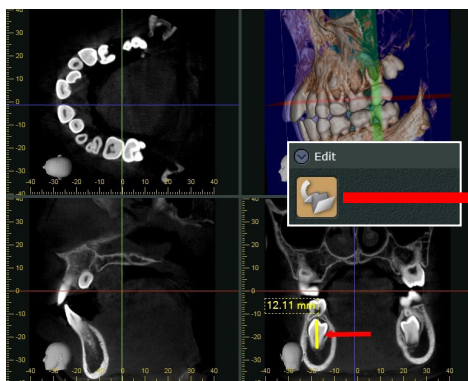

Click the thumbnail image to display the edited contents.

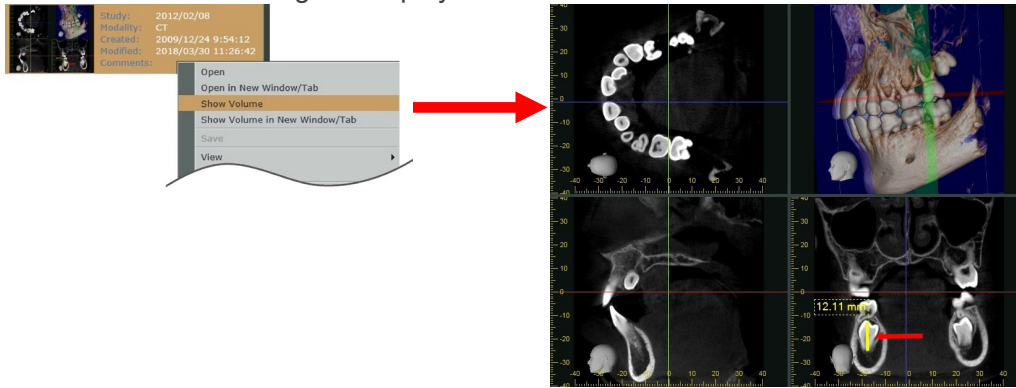

- * Panoramic images and cross section images are generated according to procedures on “Make panoramic and cross section images” (p. 128), “Make a pair of panoramic and cross section images” (p. 143).
- * The Dataset can be viewed in the “Data” section of the data panel displayed in the 3D viewer of i-Dixel as well.
An example of how a dataset is displayed in the “Data” section of the 3D viewer data panel in i-Dixel.

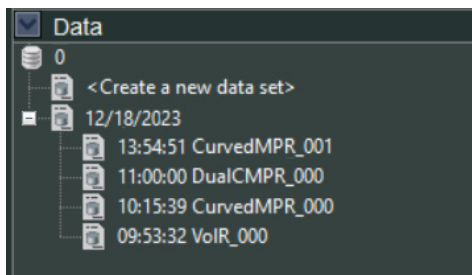

Follow the procedures below to take a snapshot.

1. Click the Snapshot button. The mouse pointer will change to a camera ().
2. Click an image that you wish to take a snapshot.

Snapshot images are saved into the patient database of i-Dixel.

Saved images are categorized into the “OtherImage” modality, and they can be selected from the image list.



Remove all previous edits from the image. The image will return to the original.



Remove the latest edit from the image. The image will return to the last saved status.



Undo the last operation.

- * The operations that can be undone are as follows.

Drawing annotation (symbols and letters), drawing implants, cutting images, drawing cMPR spline line, and switching pages

(For details on switching pages, see “12.1.2. View” (p. 126). The undo function does not support some page switching operations, such as switching whether to display the histogram panel.)



Redo the undone operation.

- * The operations that can be redone are the same as those for the undo button ().

12.1.2. View

The display can be changed in various ways: full screen, actual size, matched to viewer size, enlarged or made smaller.

Positions of the slices can be changed. The cursor lines for the slice images can be shown or hidden.

Image displays can be selected and changed.

The X, Y, and Z cursor lines for the volume-rendered image can be shown or hidden.

Panoramic and cross section images can be made.



Click this button to display the X slice image.



Click this button to display the Y slice image.



Click this button to display the Z slice image.



Click this button to display the volume-rendered image.



Click this button to display the volume-rendered image and the slice images.



Changeover to make or display panoramic and cross section images.

For details see “Make panoramic and cross section images” (p. 128), “Make a pair of panoramic and cross section images” (p. 143).



Changeover to make or display a pair of panoramic and cross sections images.

For detail see “Make panoramic and cross section images” (p. 128), “Make a pair of panoramic and cross section images” (p. 143).



Show or hide the histogram panel.

The histogram panel is used to adjust the quality of CT slice images.

It can also adjust the region of interest for volume rendered images.



For details on adjusting CT slice image quality see “CT Slice Image Quality Adjustment” (p. 147).



For details on adjusting the region of interest for volume rendered images see “Make a pair of panoramic and cross section images” (p. 143).



Click this button to hide or show the X, Y, and Z cursor planes.

See “Display X, Y, and Z Planes” (p. 159).

These buttons (  ) have the same functions as described on “10.3. Expand” (p. 64).

These buttons (  ) have the same functions as described on “11.5. CT” (p. 113).

Make panoramic and cross section images



Draw the cMPR spline on the Z slice as explained below to make panoramic and cross section images.

⚠ CAUTION

- Depending on computer performance, it may take some time to make the panoramic and cross section images.

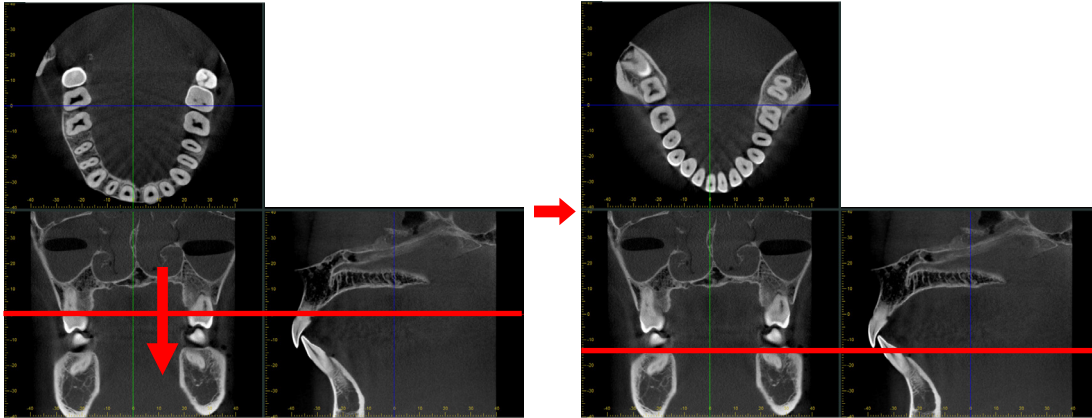
1. Drag the Z cursor to display the Z slice to be used to draw the cMPR spline.



2. Click the CMPR button (). The display for making panoramic and cross section images will appear. Click the Spline button () under "Tools" on the Main Panel.

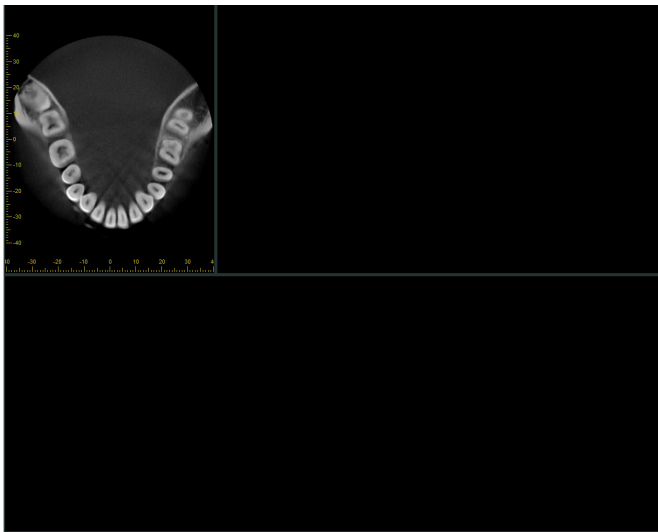

3. Move the mouse pointer to the Z slice; it will change to a plus sign: ().
4. Click to mark the starting point for the cMPR spline line. Move the mouse and click again to mark the next point.

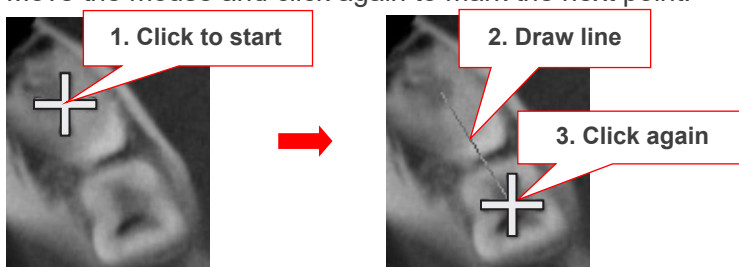

5. Continue drawing and clicking points to draw the whole cMPR spline line.

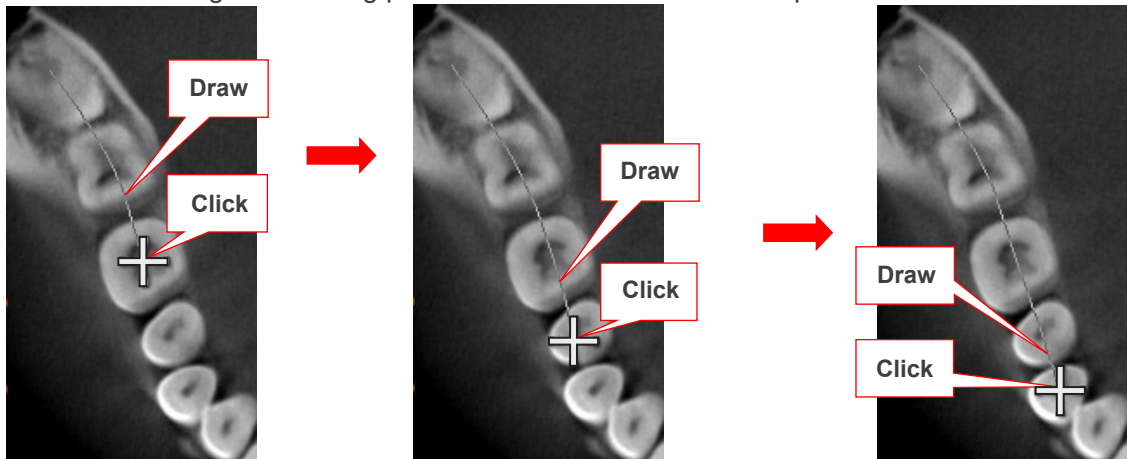

6. Double-click to mark the end of the cMPR spline line. Production of the panoramic and cross section images will commence.

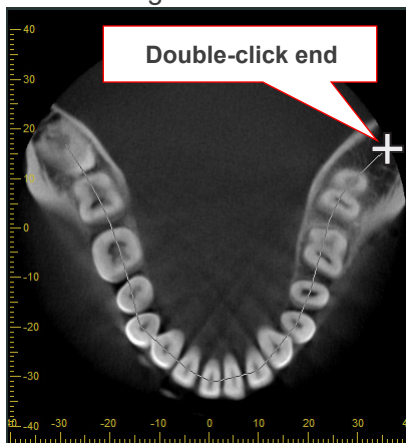

7. The panoramic and cross section images will be displayed.

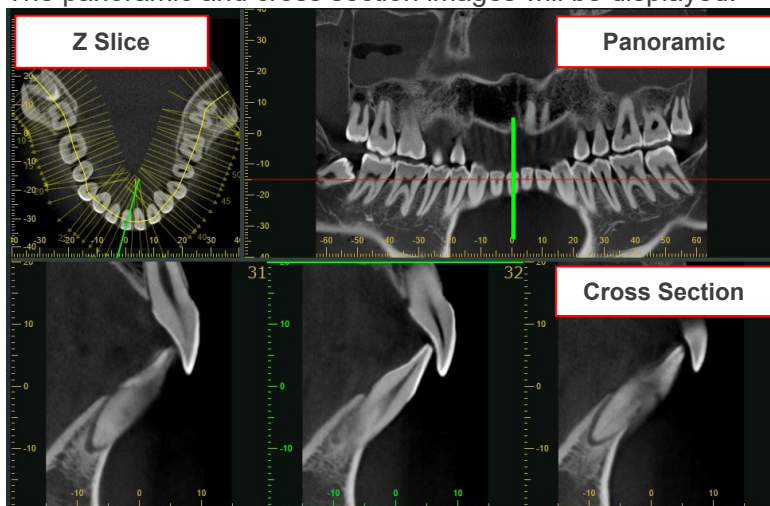

Also lines crossing the cMPR spline line will appear.

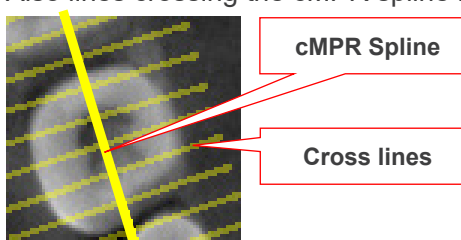

The lines crossing the spline represent the cross section images.
 The length of the lines shows the width of the cross section images.
 The positions of the lines show the location of the cross section images.

Regardless of the position, the cross-sectional image is always displayed facing the lingual side to the left, buccal side to the right.

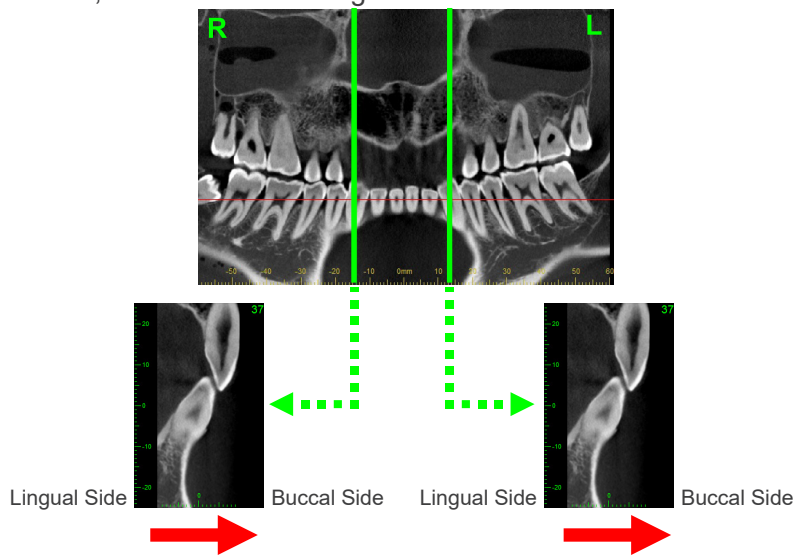

Displaying Z Slice Images

Drag the horizontal line in the panoramic image to change the position of displayed Z slice.

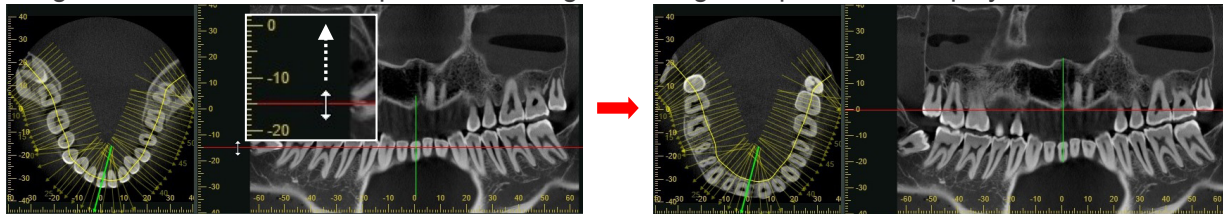

You can also change the position of displayed Z slice by clicking the button for switching the display of CT slice images () and dragging the Z slice, as explained in “12.1.3. Tools” (p. 160) .

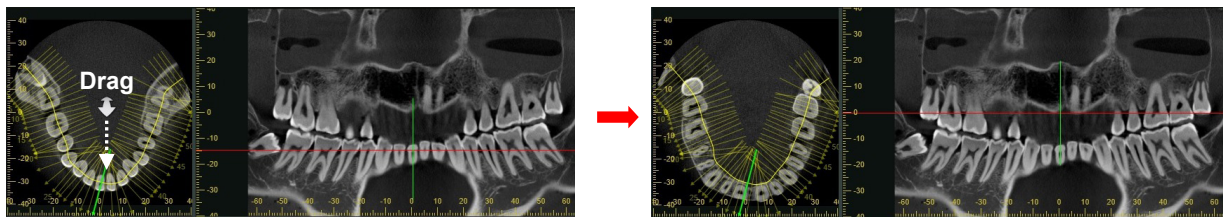

Displaying Cross Section Images

Drag the vertical line in the panoramic image to change the display of cross sections.

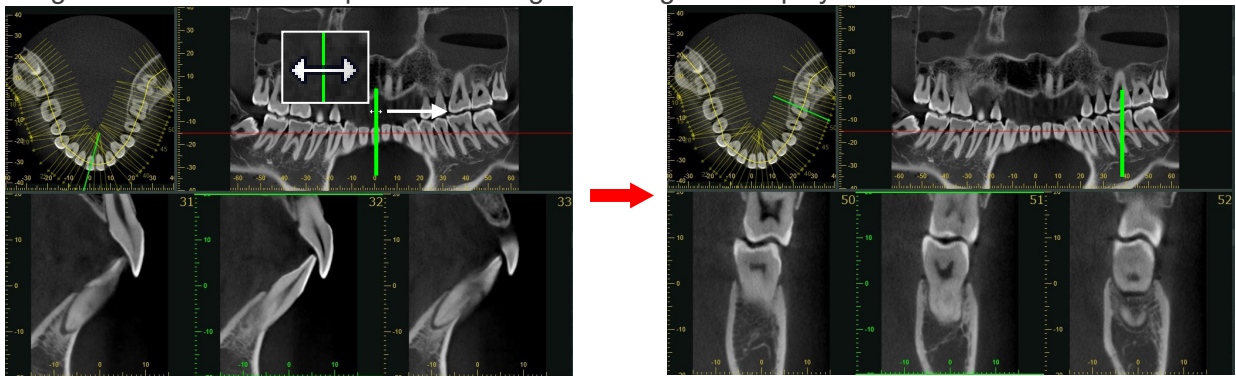

- * You can also change the display of cross sections by putting the mouse cursor on the cross section and rotating the mouse wheel forward or backward.
- * The length of the vertical line represents the height of the cross section.

Change Width of Cross Sections

Drag the lines perpendicular to the spline in the Z slice to adjust the width of the cross section images.

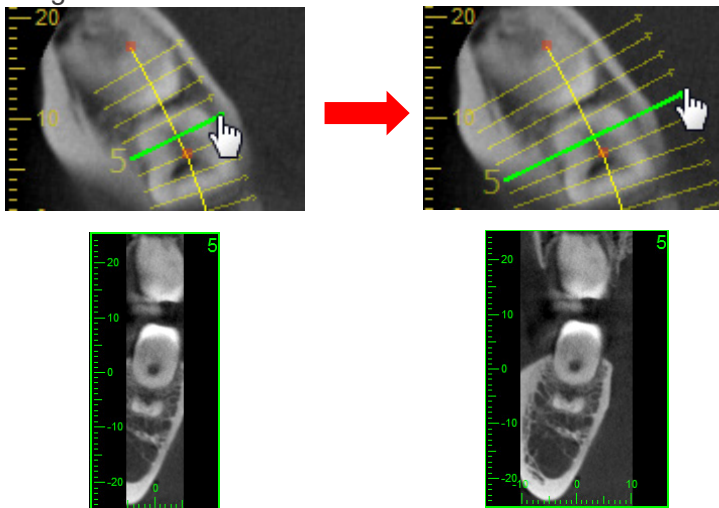

Specify Panorama Mid-sagittal Line

When the mid-sagittal line is specified, the cross sections will face either right or left depending on which side of the line they are on.

1. Right-click the panoramic image or the axial image, and then select "Mid-sagittal Line" from the pop-up menu.

Example: When right-clicking the panoramic image

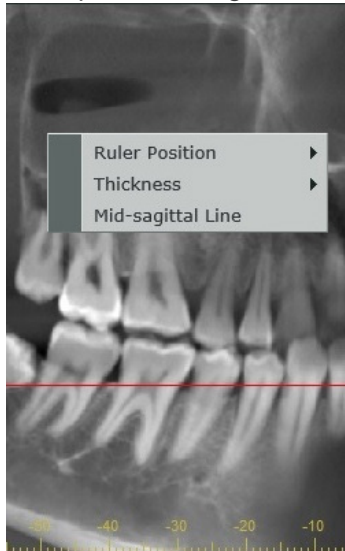

* Click the mid-sagittal line to switch it as either displayed or hidden.

2. A vertical white line will appear in the panoramic image.
Drag it left or right to change its position.
A white line will also appear in the axial image.

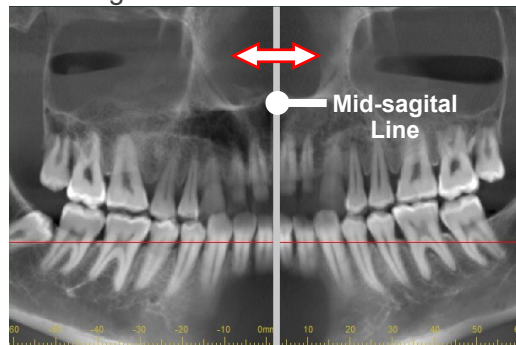
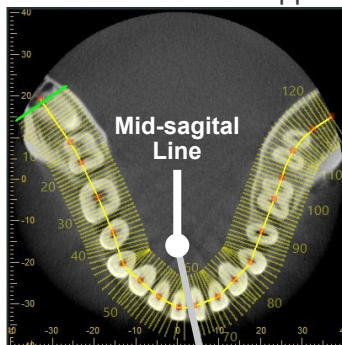

As shown in the illustration below, the cross-sectional image is displayed facing symmetrically from the mid-sagittal line.

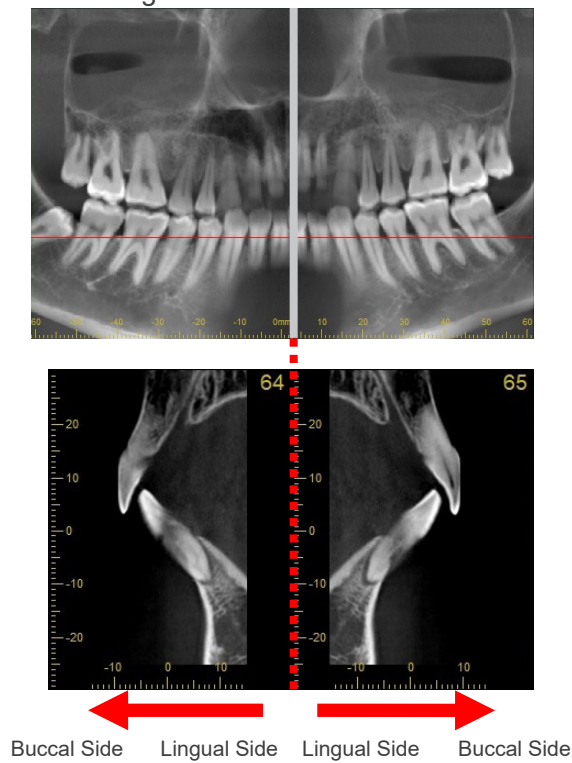

The direction of the arrows representing the cross sections in the axial image will also change depending on which side of the mid-sagittal line they are on.

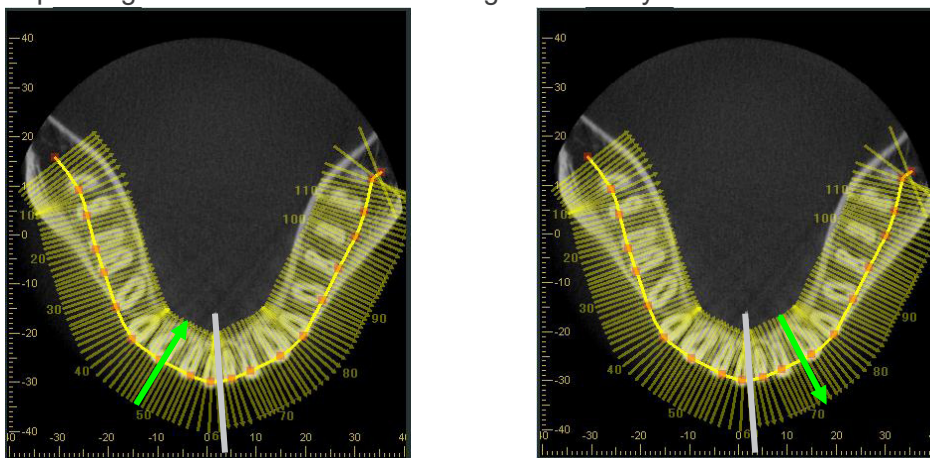

If some of the lines overlap the mid-sagittal line, the arrows will appear as shown below.

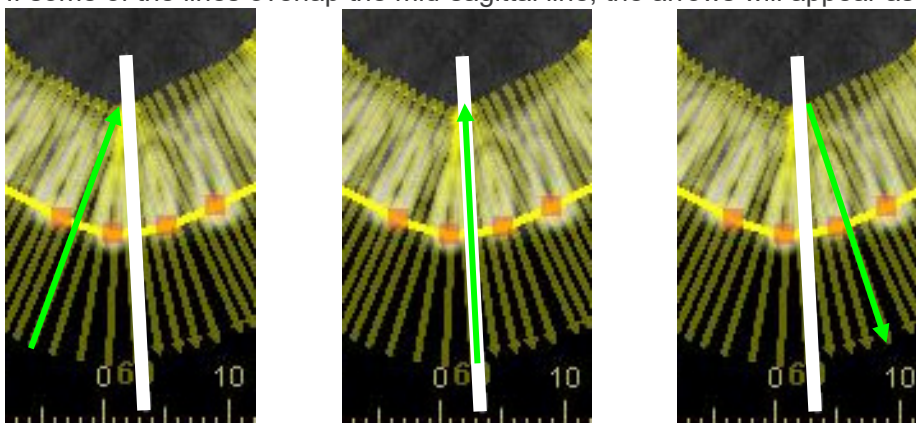

Change the Shape of cMPR Spline Line

The shape of cMPR spline line can be changed in the following way. Changing the shape of the cMPR spline line allows panoramic images and cross section images to be regenerated.

- Rotating the mouse wheel
 1. Put the mouse cursor on the panoramic image.

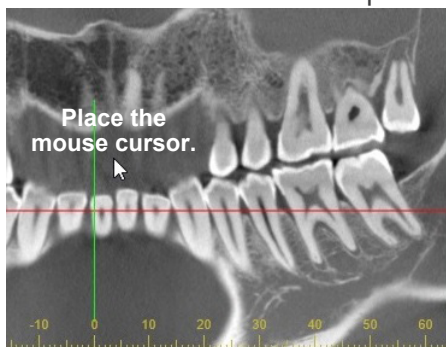

2. Rotate the mouse wheel.
Rotating forward expands the line to the buccal side.

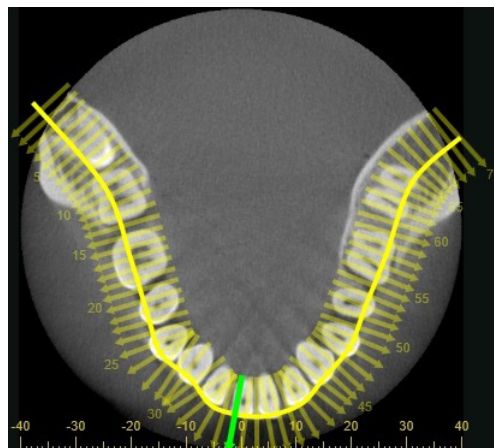
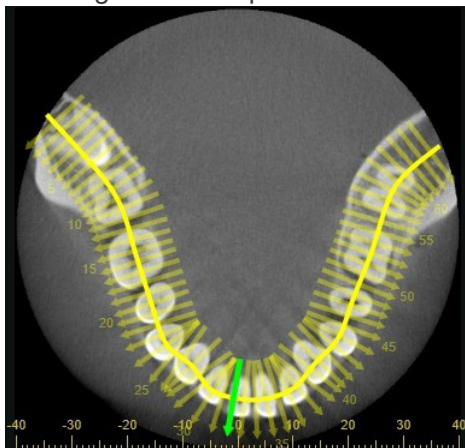

Rotating backwards shrinks the line to the lingual side.

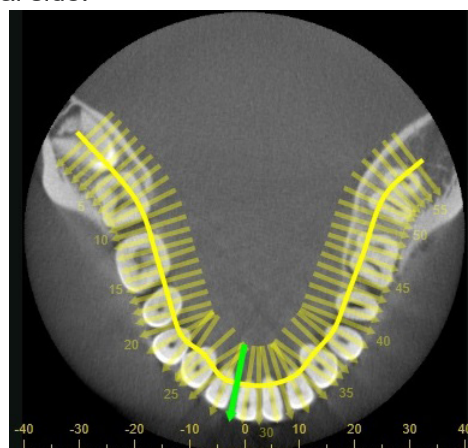
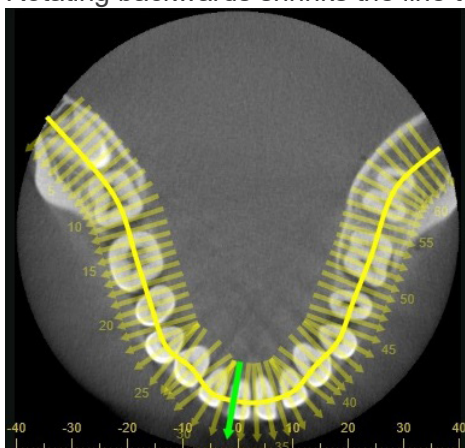

- Dragging the panoramic image
 1. Click the button to switch the display of the CT slice explained in “12.1.3. Tools” (p. 160) .
 2. Put the mouse cursor on the panoramic image.

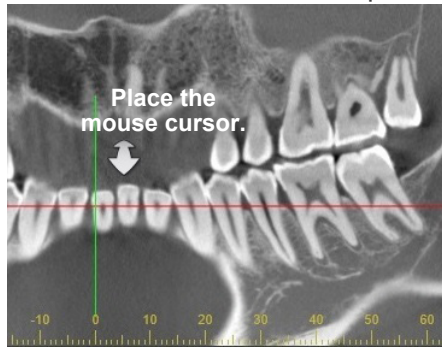

3. Drag the panoramic image.
Dragging upward expands the line to the buccal side.

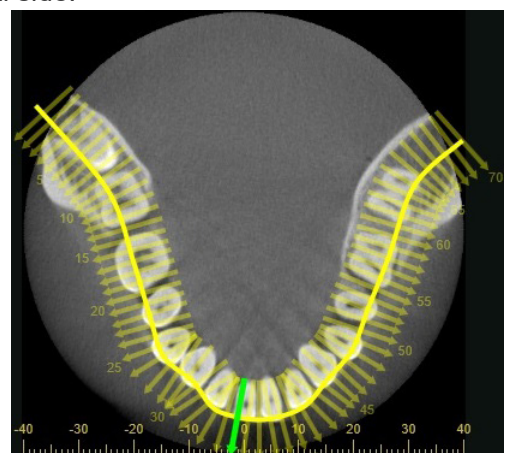
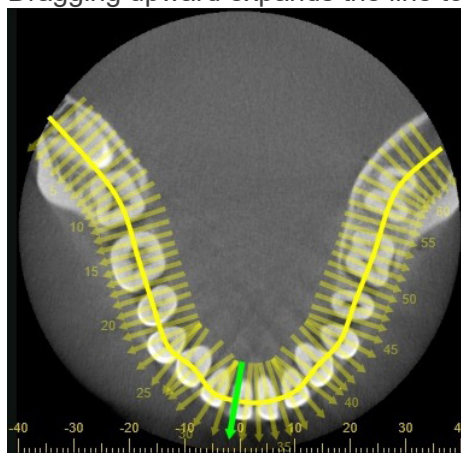

Dragging downward shrinks the line to the lingual side.

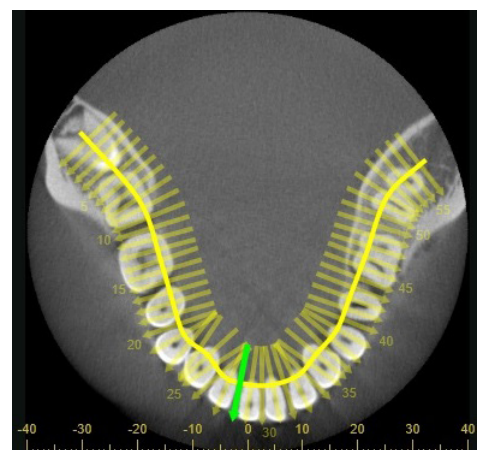
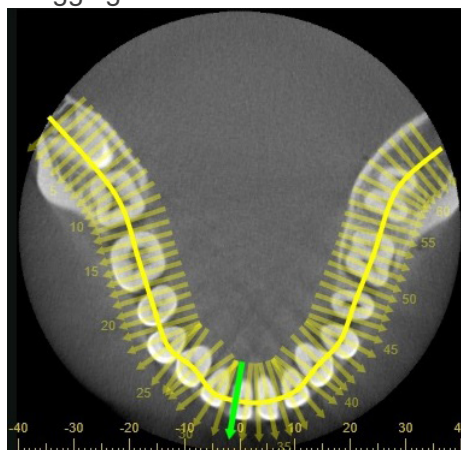

- Dragging the control point.

1. Right-click the cMPR spline line and select "Direct Selection". Control points are displayed on the Z-slice image.

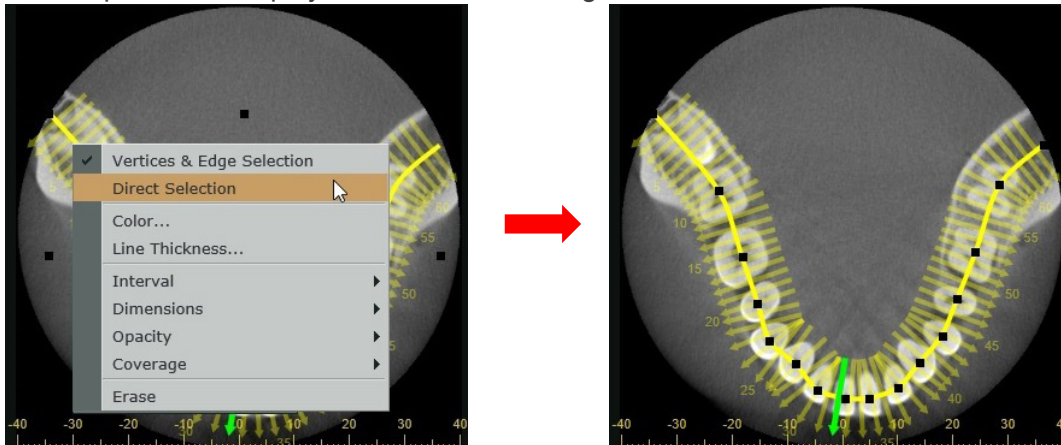

* Control points are the points clicked when drawing the cMPR spline line.

2. Drag the control point.

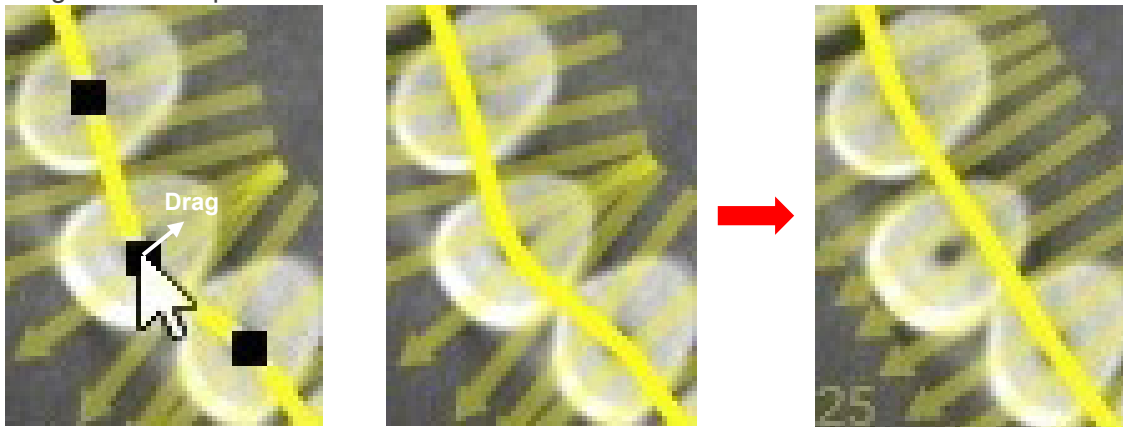

- Dragging the vertex or the middle of the edge.

1. Right-click the cMPR spline line and select "Vertices & Edge Selection". The vertices are displayed on the Z-slice.

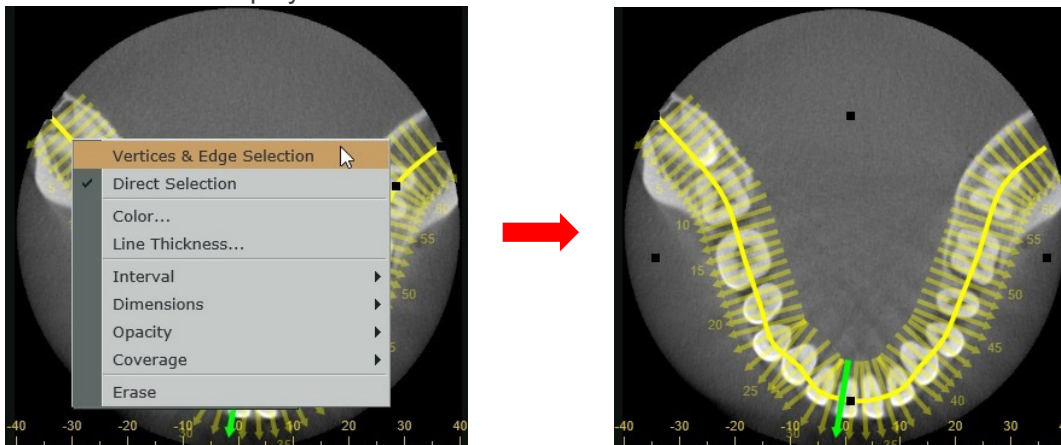

* The vertices and the center of the edges appear, surrounding the entire cMPR spline line. The dots marked 1 in the figure below are the vertices and dots marked 2 are the edge centers.

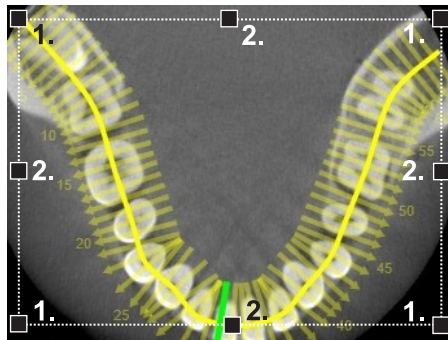

2. Drag the vertices or the center of the edges.

When dragging the vertices

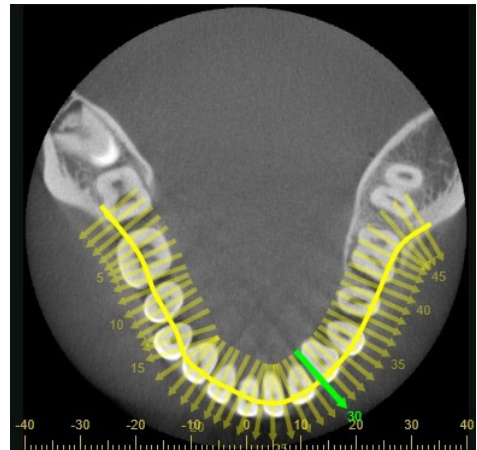
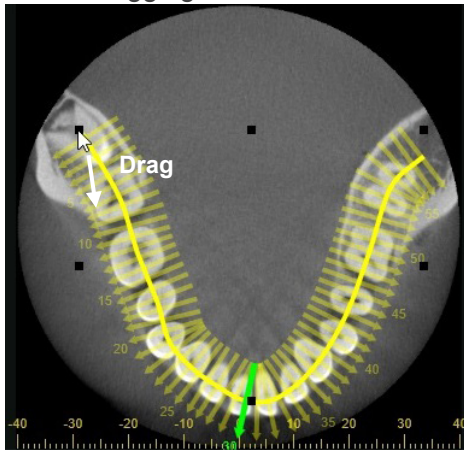

When dragging the edge center

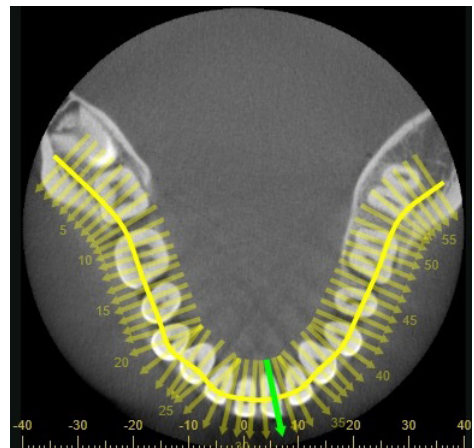
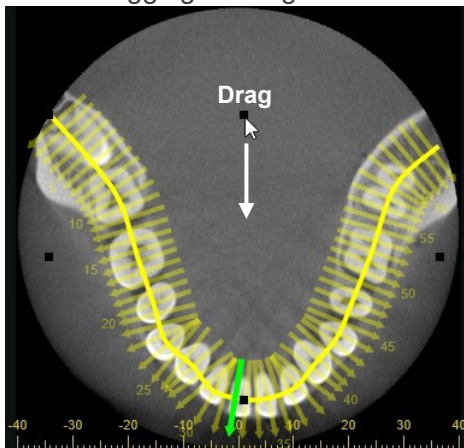

Draw cMPR Spline Line Automatically

You can generate panoramic images and cross sections by automatically drawing the cMPR spline line based on the standard panorama spline.

However, automatic drawing is not available in the following cases.

- The length and width of the Z slice image are less than 80 mm.
- A cMPR spline line is drawn in the Z slice image.

1. Right-click the Z slice image and select “Add Panoramic Spline”.

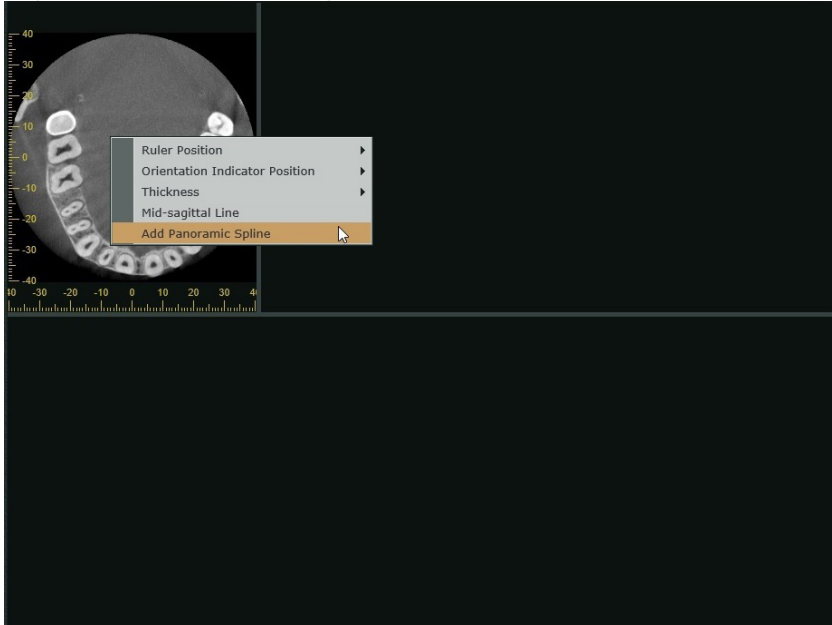

2. A cMPR spline line is automatically drawn on the Z slice image, and the panoramic and cross section images are generated.

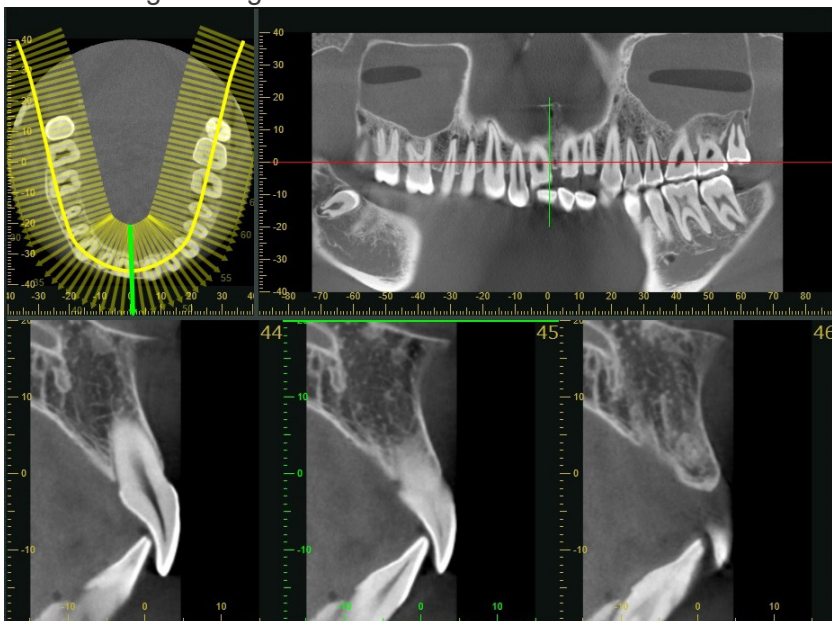

You can change the shape of the cMPR spline line drawn automatically according to “Change the Shape of cMPR Spline Line” (p. 134).

Furthermore, when the following conditions are satisfied, clicking the CMPR button  will automatically draw a cMPR spline line on the Z slice image based on the standard panorama spline, generating the panoramic and cross section images.

- The XYZ view displays a Z slice image with the length and width of 80 mm or longer.
- No cMPR spline line is drawn on the Z slice image in the CMPR view.

Pop-up Menu When a cMPR Spline Line Is Drawn

When right-clicking the cMPR spline line, the pop-up menu below will appear.



Vertices & Edge Selection

Change the shape of the cMPR spline line by dragging the vertices and the edge centers, as explained in “Change the Shape of cMPR Spline Line” (p. 134).

Direct Selection

Change the shape of the cMPR spline line by dragging the control points displayed on the cMPR spline, as explained in “Change the Shape of cMPR Spline Line” (p. 134).

Color...

Change the color of the cMPR spline line, cross lines, and letters.

Line Thickness...

Change the thickness of the cMPR spline line and cross lines.

Interval

Change the slice interval for generating cross section images by slicing the CT volume data. Changing the interval will regenerate the cross section images. The narrower the slice interval, the more cross section images will be generated.

Dimensions

Change the length and width of the cross section images. Changing the size will regenerate the cross section images.

Opacity

Change the opacity of the cross lines and letters (the number of generated cross section images). The closer the opacity is set to 0, the less visible the cross lines and text (the number of generated cross section images).

Coverage

Change this item to hide a part of cross lines.
Reducing the coverage will hide a part of cross lines.

Example: Reducing the coverage from 100 to 50

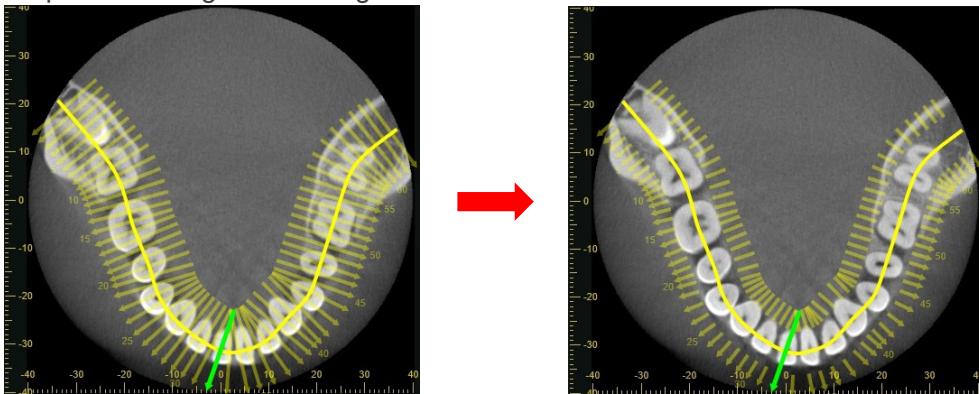

Erase

Delete the cMPR spline line.
Deleting the cMPR spline line will delete the cross section and panoramic images.

Pop-Up Menu for Generated Panoramic Image and Cross Section Images

When right-clicking the axial image, panoramic image, or cross section image, the pop-up menu below will appear.

- Axial image

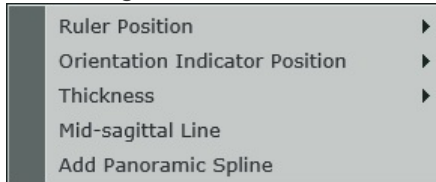

Ruler Position:

Change the display position for the ruler in the axial image.

Orientation Indicator Position:

Change the display position for the orientation indicator in the axial image.

Thickness:

Change the slice thickness for the axial image.

To reduce the noise and artifacts, an increase in thickness is effective.

To check fine anatomy, decrease thickness.

Mid-sagittal Line:

Switch between displaying or hiding the mid-sagittal line as described on “Specify Panorama Mid-sagittal Line” (p. 132).

Add Panoramic Spline:

Automatically draw the cMPR spline line based on the standard panorama spline, as explained in “Draw cMPR Spline Line Automatically” (p. 137).

- Panoramic image

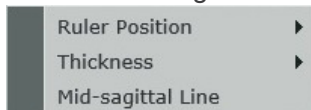

Ruler Position:

Change the display position for the ruler in the panoramic image.

Thickness:

Change the slice thickness for the panoramic image.

To reduce the noise and artifacts, an increase in thickness is effective.

To examine fine anatomy, decrease thickness.

Mid-sagittal Line:

Switch between displaying or hiding the mid-sagittal line as described on “Specify Panorama Mid-sagittal Line” (p. 132).

- Cross section image

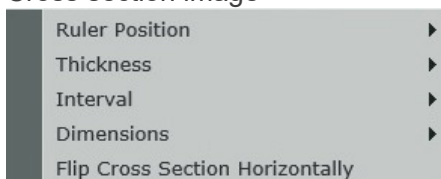

Ruler Position:

Change the display position for the ruler in the cross section image.

Thickness:

Change the slice thickness for the cross section image.
To reduce the noise and artifacts, an increase in thickness is effective.
To examine fine anatomy, decrease thickness.

Interval:

Change the slice interval for the cross section image.
If you set it narrower, it will result in an increasing number of orthogonal lines and cross section images.

Example: Change the slice interval from 5 mm to 1 mm

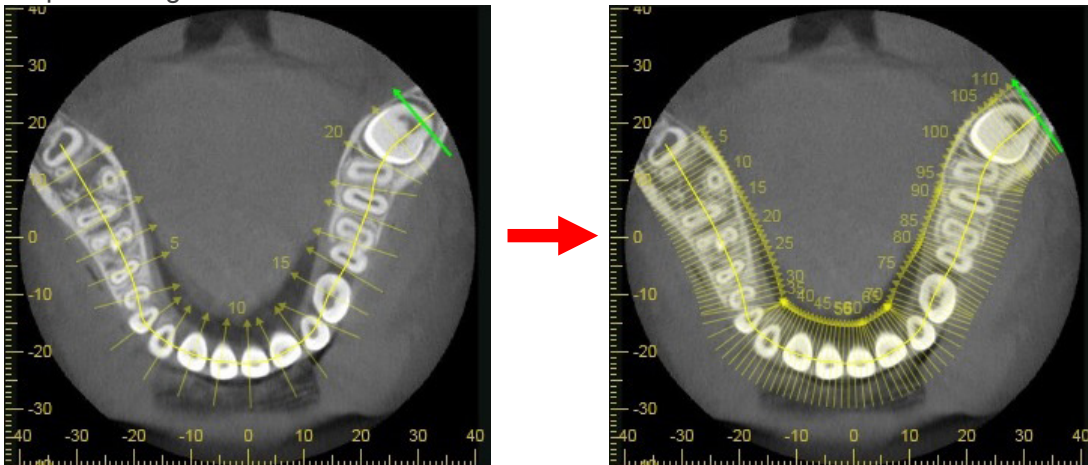

* Numbers on the image are display order of the cross section images.

Dimension:

Change display size for the cross section image.

Example: Change the size from 40 × 60 mm to 20 × 30 mm

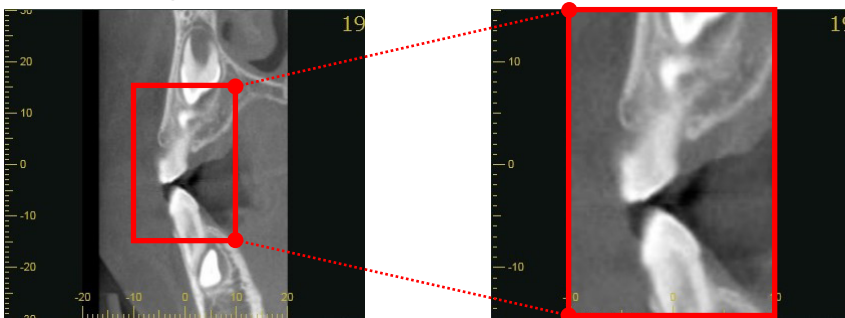

Flip Cross Section Horizontally:

Switch the display direction of the cross section image.

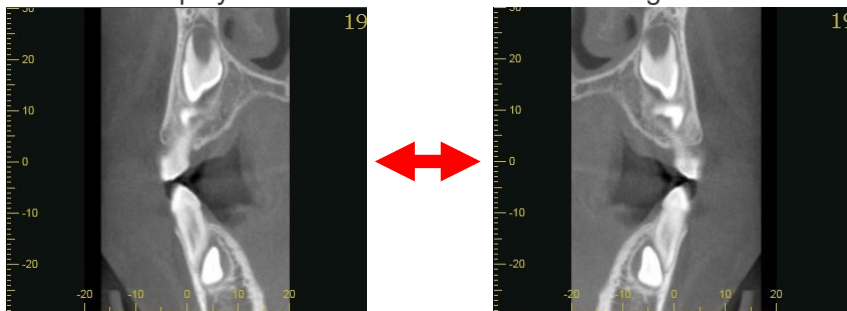

Make a pair of panoramic and cross section images



The instructions below tell how to draw 2 spline lines on the Z slice to make a pair of panoramic and cross section images.

⚠ CAUTION

- Depending on computer performance this may take some time.

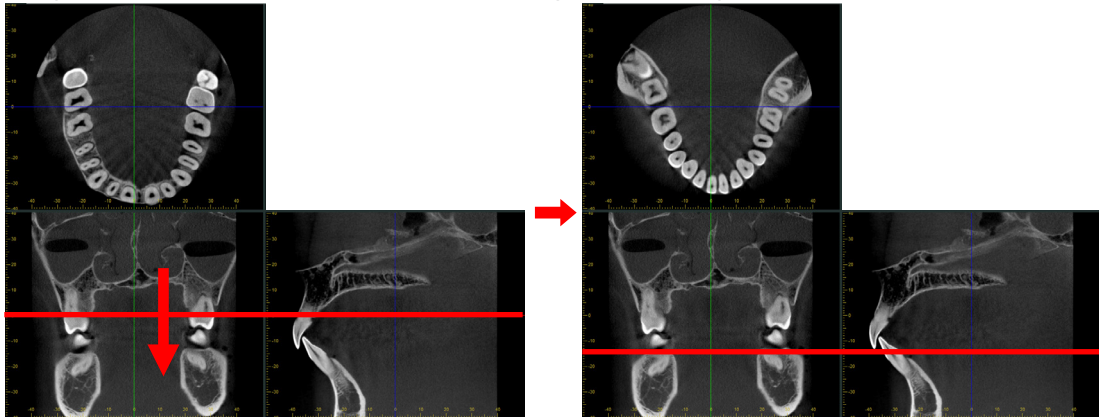
1. Drag the Z cursor line to set the Z plane image for drawing the cMPR spline line.



2. Click the Dual cMPR button (). The panel will switch to the one for making panoramic and cross section images. Click the Spline button () under “Tools” on the Main Panel.

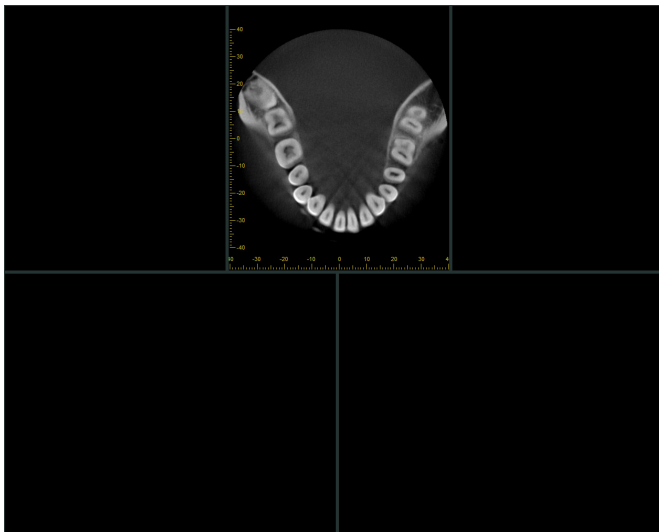

3. Follow the instruction on “Make panoramic and cross section images” (p. 128) and draw the first cMPR spline line on the Z slice. Double-click the last point to finish the line. The first set of panoramic and cross section images will start processing.

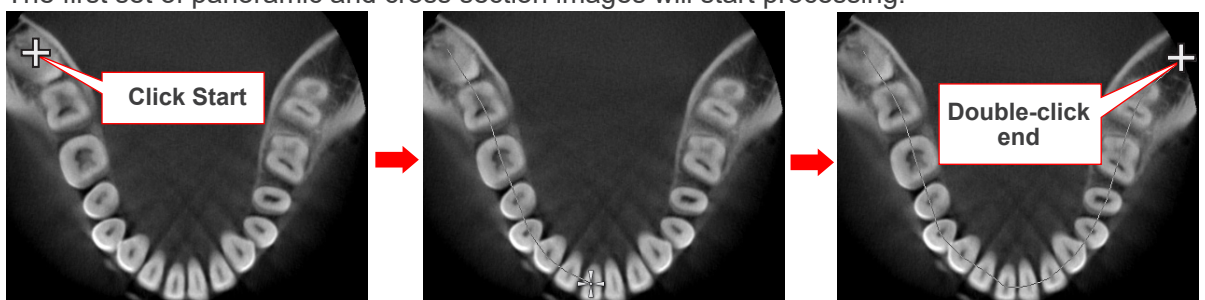

4. The first set of images will appear on the left side.

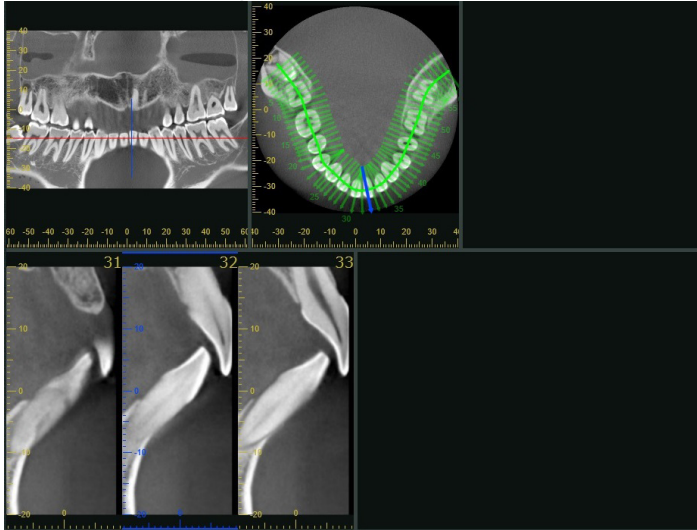

Also lines crossing the cMPR spline line will appear.

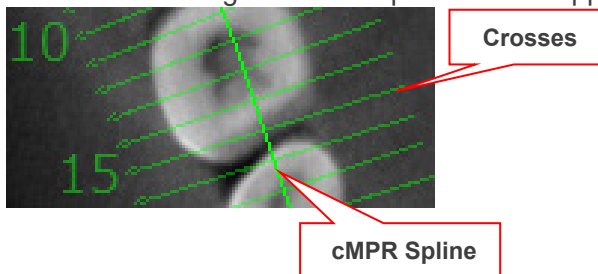



5. Make another Z slice to draw the 2nd cMPR spline line.

1) Go to the Tools section in the Main Panel and click the XYZ button ().
CT slice and volume rendered images will be displayed.

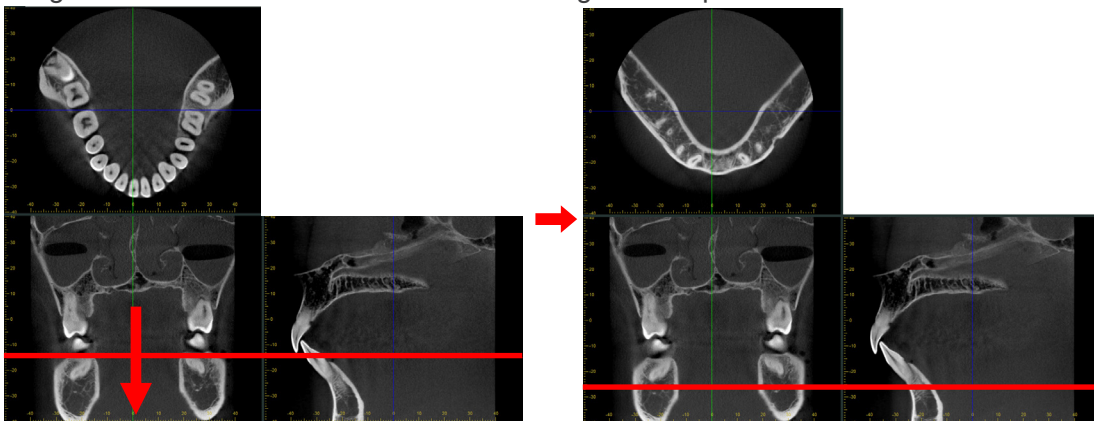
2) Drag the Z cursor to select a Z slice for drawing the 2nd spline line.



3) Go to the Tools section in the Main Panel and click the Dual cMPR button () to display the panel for making panoramic and cross section images.

Click the Spline button () under "Tools" on the Main Panel.

6. Follow step 3 to draw the second cMPR spline line. Double-click to finish the line. Processing for the second set of images will commence.

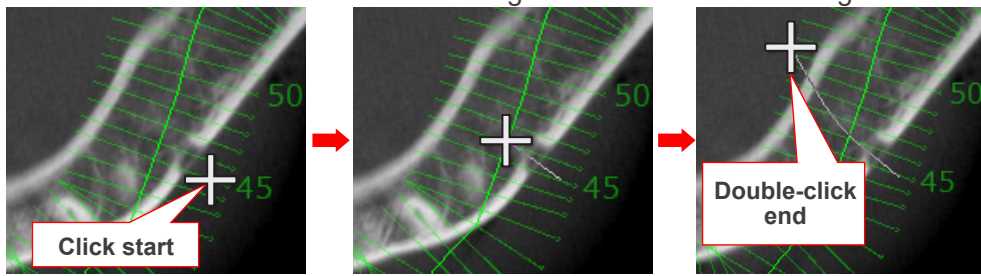

7. The second set of panoramic and cross section images will appear on the right.

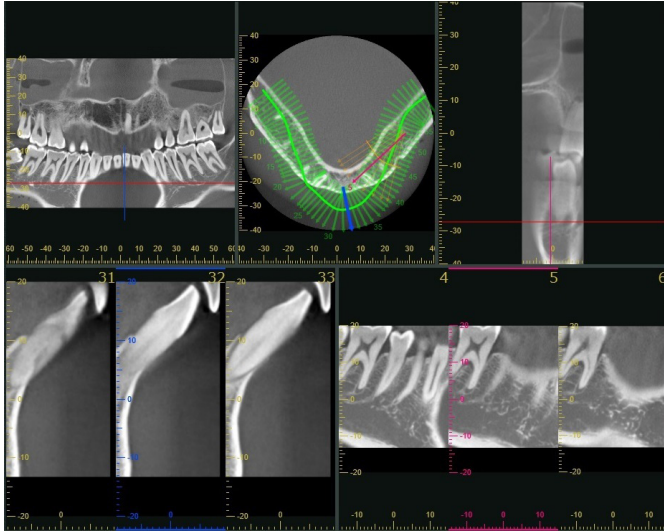

Also short lines crossing the 2nd spline line will appear.

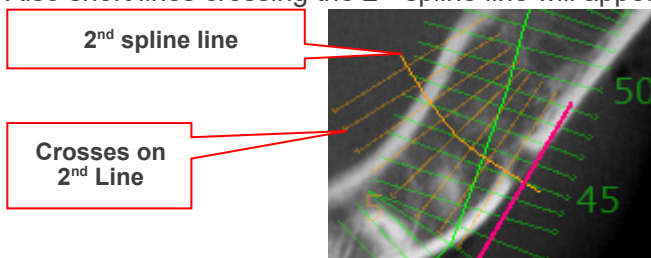

Drag the cursor line to change the display of cross sections.

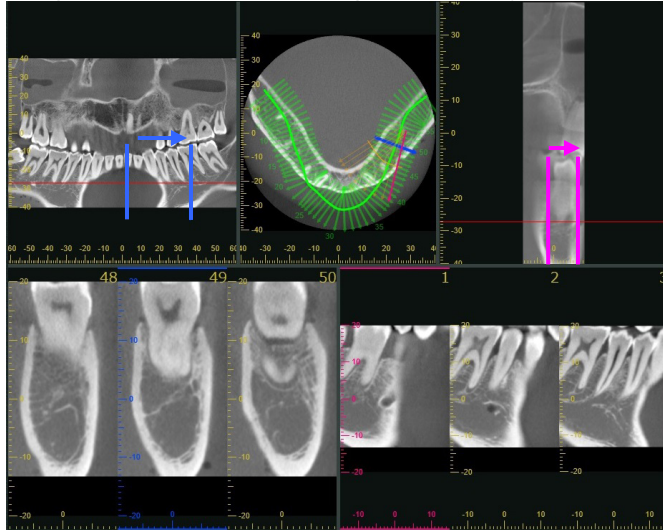

See “Make panoramic and cross section images” (p. 128) for the significance of the lines crossing the spline line.

As explained in “Displaying Z Slice Images” (p. 130) , the display of the Z slice can be switched.

As explained on “Displaying Cross Section Images” (p. 131) , “Change Width of Cross Sections” (p. 131), the cross sections display can be adjust and the width of the cross sections can be changed.

As explained in “Specify Panorama Mid-sagittal Line” (p. 132) , the mid-sagittal line of the panoramic image can be specified.

As explained in “Change the Shape of cMPR Spline Line” (p. 134) , the shape of the cMPR spline line can be changed.

As explained in “Draw cMPR Spline Line Automatically” (p. 137) , the cMPR spline line can be drawn automatically.

Pop-up Menu after Drawing 2 Pairs of cMPR Spline Lines

Right-click either of the cMPR spline lines to display the pop-up menu.

See “Pop-up Menu When a cMPR Spline Line Is Drawn” (p. 139) for more information.

Pop-Up Menu after Generating 2 Pairs of Panoramic Images and Cross Section Images

Right-click the axial image to display the pop-up menu described on “• Axial image” (p. 141).

Right-click either of the panoramic images to display the pop-up menu described on “• Panoramic image” (p. 141).

Right-click either of the cross section image to display the pop-up menu described on “• Cross section image” (p. 141).

See “Pop-Up Menu for Generated Panoramic Image and Cross Section Images” (p. 141) for more information.

CT Slice Image Quality Adjustment

Click the Grayscale button (**Grayscale**) to bring up the display shown below.

Adjust the image quality by watching the histogram as you tilt the contrast curve and adjust the WW (window width), WL (window level) and brightness level.

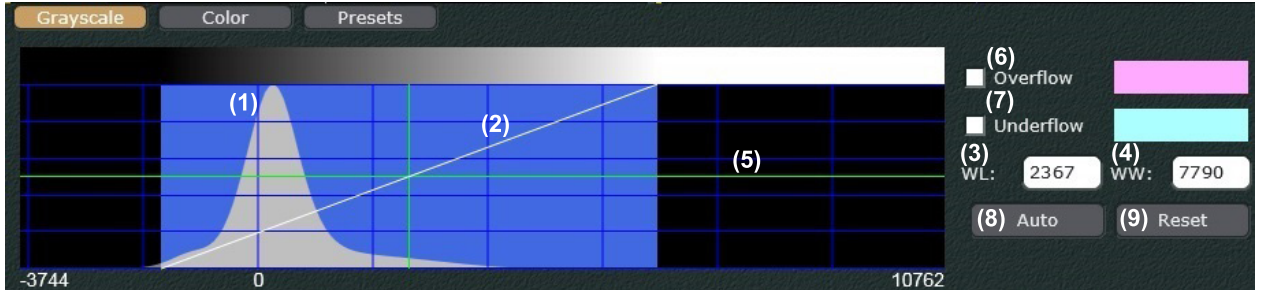

- (1) Voxel value histogram
This displays the pixel value distribution for the CT volume data.
The histogram will show how much tooth, bone and other elements are in the volume data.
- (2) Contrast Curve
Tilting this adjusts the contrast.
WW (window width) is linked to this and will also change when it is tilted.
- (3) WL (window level)
Setting the WL will set the voxel value for the center of the WW.
You can enter the number directly or move the vertical line in the histogram to the right or left.
- (4) WW (window width)
The range of the voxel values will change along with the contrast curve.
You can enter the number directly or tilt the contrast curve
- (5) Brightness Level
Move the horizontal line in the histogram up or down to adjust the brightness.
- (6) Overflow
Set the color for voxels that have larger values than the WW range.
- (7) Underflow
Set the color for voxels that have smaller values than the WW range.
- (8) Auto
WL (window level), WW (window width), and Brightness Level will be set automatically.
- (9) Reset
WL (window level), WW (window width), and Brightness Level will be reset as shown in the image on the lower right.

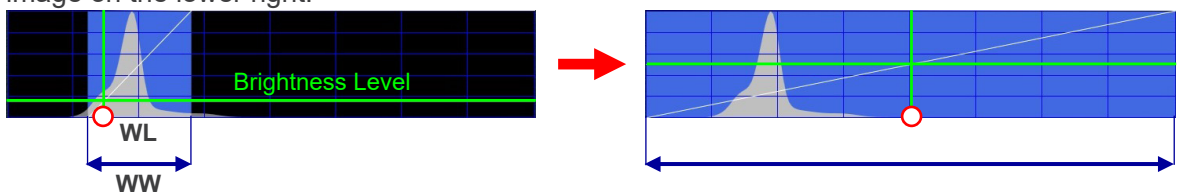

Example: Adjust Contrast and Brightness

1. Drag the intersection of the WL (window level) and brightness level to adjust WL and brightness.

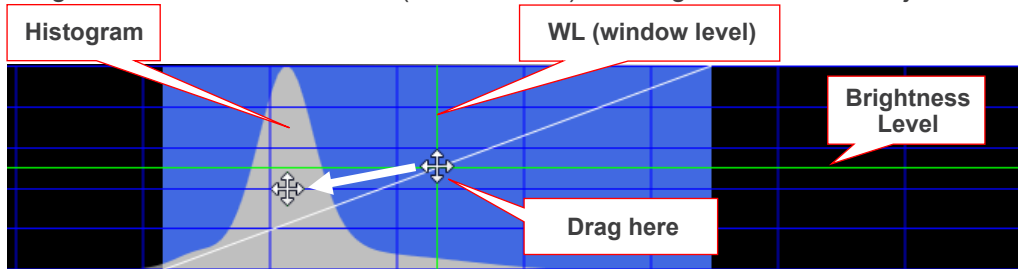

2. Drag contrast curve to adjust contrast

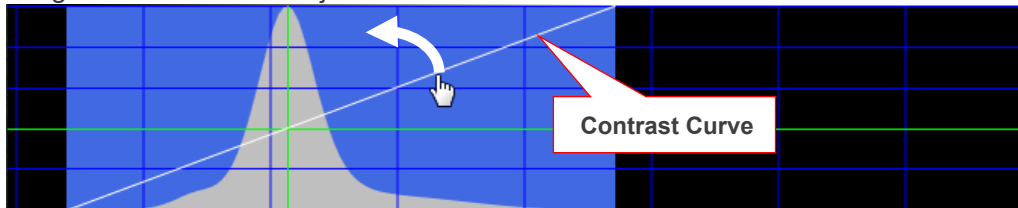

3. The CT Slice will be displayed as adjusted.

The example below shows how image quality has been adjusted by lining up the WL (window level) with the peak of the histogram, setting the brightness level at the second step, and tilting the contrast curve considerably.

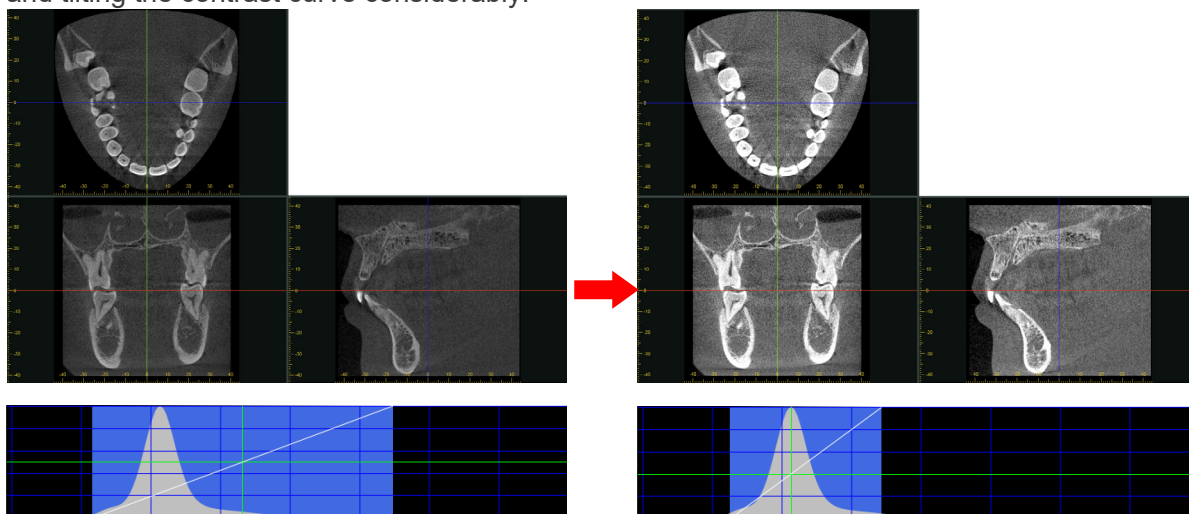

Adjust the Volume of Interest for Volume Rendered Images

Click the Color button (**Color**) to change the display as shown below.
 Watch the histogram and move the opacity curve to display teeth, bone, etc. as the volume of interest.

The opacity curve can be changed by selecting its type and tilt, and by adjusting the WW (window width), WL (window level), and the opacity level.

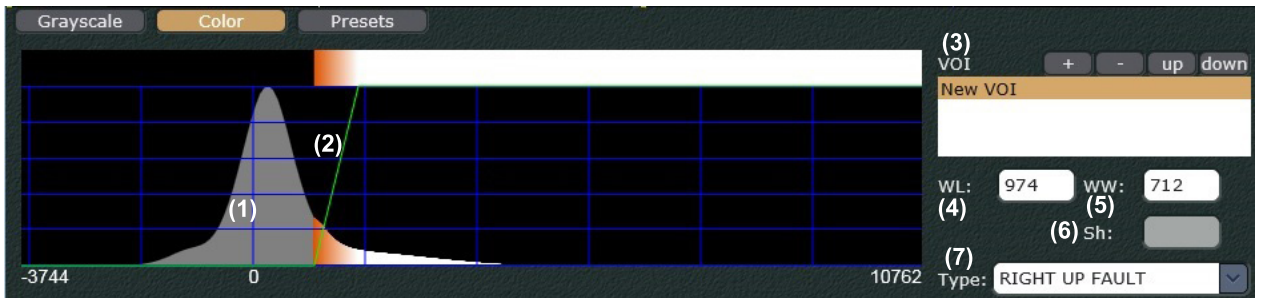

* "Sh" is enabled only when the trapezoid opacity curve is selected.

- (1) Voxel Value
 This shows the distribution of voxel values in the CT volume data.
 The histogram shows the amount of hard tissue (teeth, bones, etc.) voxels and the amount of soft tissue (gums etc.) in the CT volume data.
- (2) Opacity Curve
 Adjust the opacity curve to determine the volume of interest for volume rendered images.
- (3) VOI
 This determines the color of the volume of interest and is used to register or delete it and to hide or show it.
 It also determines the display priority order when there are multiple volumes of interest.
- (4) WL (window level)
 This determines the reference point for the opacity curve.
 The opacity curve's reference point depends on the type of opacity curve selected.

"LEFT UP FAULT"

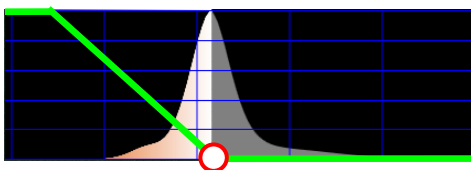

"LEFT UP TRIANGLE"

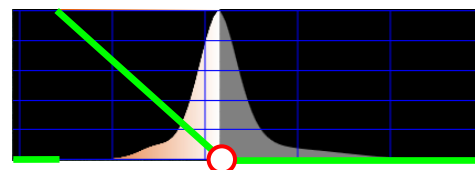

"TRAPEZOID"

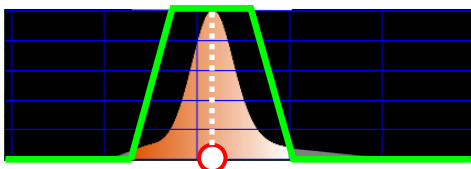

○ : WL

"RIGHT UP FAULT"

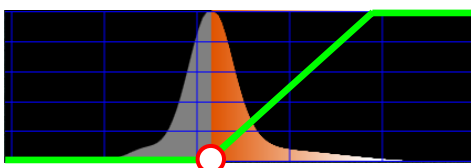

"RIGHT UP TRIANGLE"

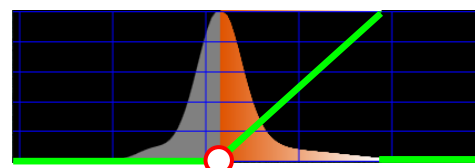

(5) WW (window width)
This is the range of voxel values as determined by the opacity curve.
The value can be entered directly or by changing the opacity curve.

(6) Sh
This is enabled only when the trapezoid opacity curve is selected.
The “Sh” corresponds to the shape of the trapezoid.
If “Sh” is 0, the opacity curve will be an isosceles triangle. If it is 1, it will be a rectangle.

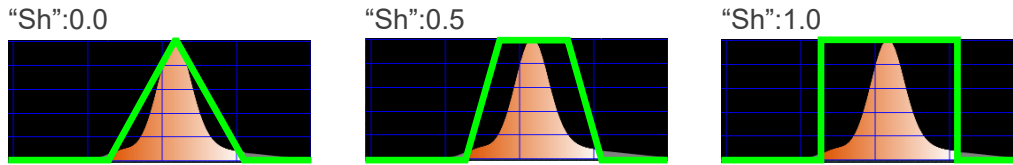

The “Sh” value can be entered directly or by changing the opacity curve.

(7) Type
Basic types of opacity curves may be selected.

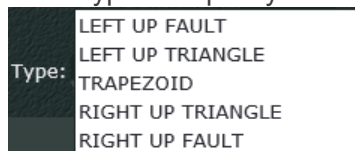

“LEFT UP FAULT” and “LEFT UP TRIANGLE” are effective for eliminating voxels with very small values such as air.

“TRAPEZOID” is effective for displaying multiple tissues.

“RIGHT UP FAULT” and “RIGHT UP TRIANGLE” are effective for eliminating voxels with large values such as teeth and bone.

* For examples of basic opacity curves see “(4) WL (window level)” (p. 149).

Example: Narrow down the volume of interest to teeth

Opacity is adjusted by dragging the upper and lower horizontal lines of the opacity curve. Lowering the opacity will narrow the volume of interest down to the teeth.

Below is a volume rendered image using the "RIGHT UP FAULT" opacity curve. Dragging the upper line down lowers the opacity. The volume of interest is narrowed down to the teeth.

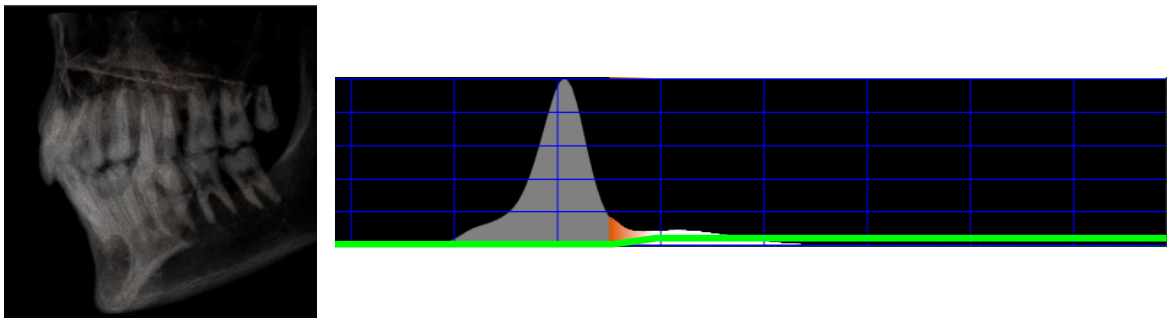
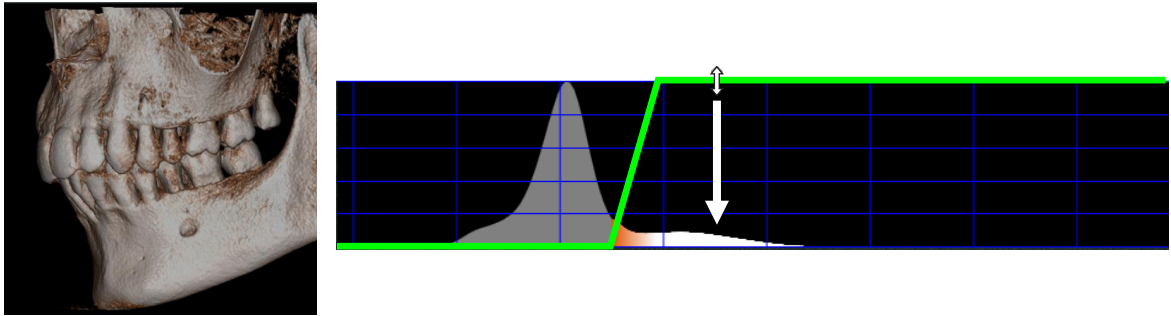

Example: Multiple volumes of interest

Volume rendered images can be display for multiple volumes of interest.



The images above can be displayed as explained below.

1. Select 1st volume of interest and register its name and color.

1) Adjust the opacity curve

1-1) Select the "RIGHT UP FAULT" opacity curve.

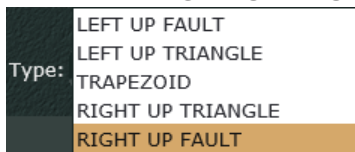

1-2) Drag the opacity curve right to adjust the WL.

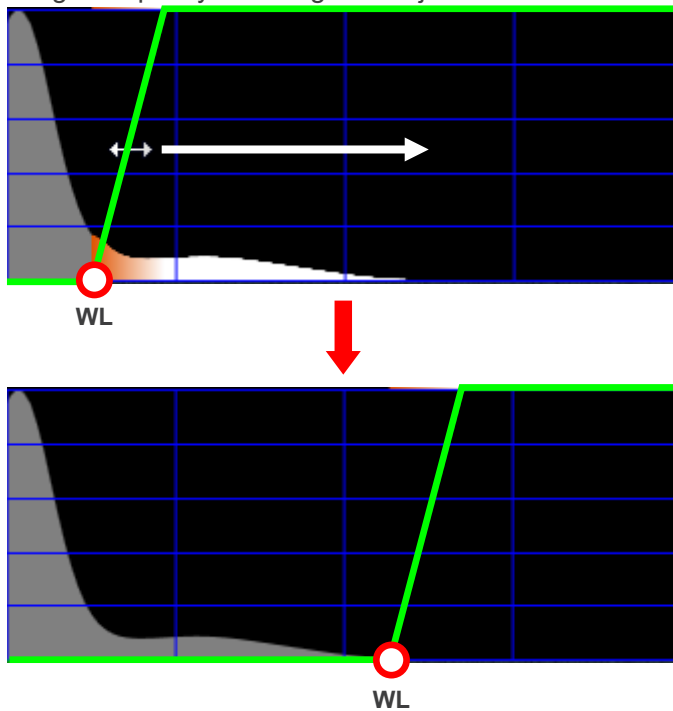

1-3) Drag the left end of the upper line.

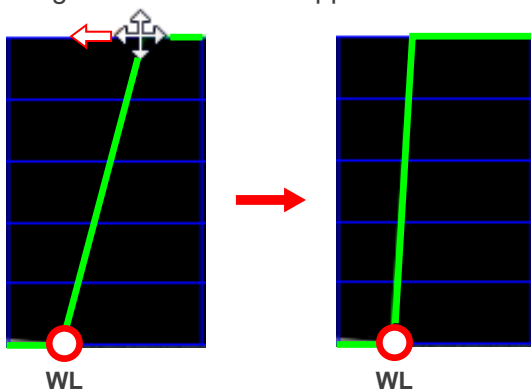

2) Register the name and color of the volume of interest.

2-1) Double-click "New VOI" in the VOI list.



2-2) Enter the VOI (Volume Of Interest) to “Name” in the dialogue box.

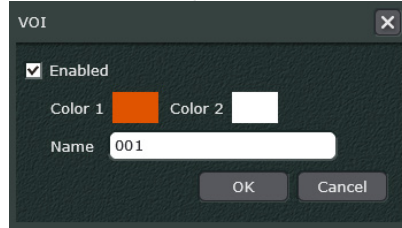

Click the “Color 1” box.
Select the color from the dialogue box and click the OK button.

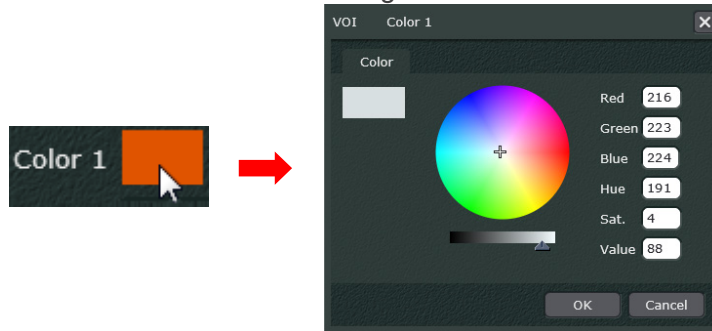

Check the name and color and then click the OK button.

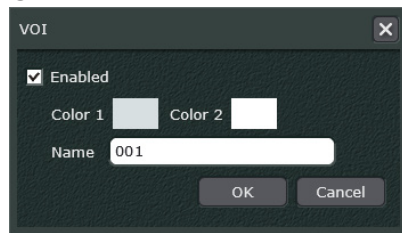

2. The registered volume of interest will be displayed.
The opacity curve will also be displayed.

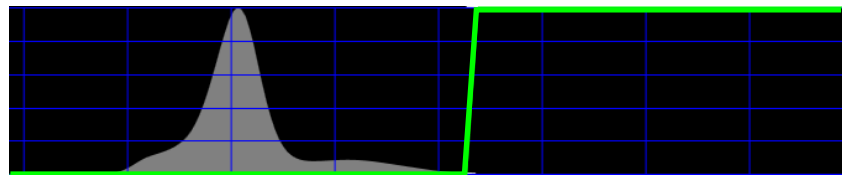

3. To make it easier to make the 2nd volume of interest, hide the first one.
 - 1) Double-click the 1st volume of interest in the “VOI” list.



2) Remove the check from the "Enabled" box and click the OK button.

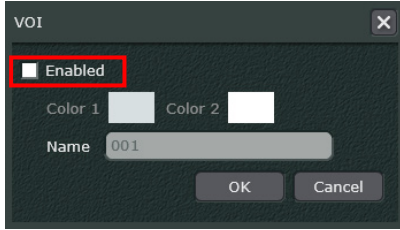

4. Select 2nd volume of interest and register its name and color.

1) Click the Plus button (+) in the "VOI" heading.



2) "New VOI 0" will be added. Select "New VOI 0".



3) Adjust the opacity curve.

3-1) Select the "TRAPEZOID" opacity curve.

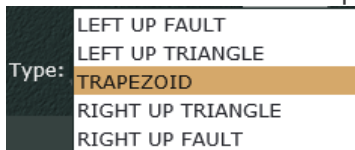

3-2) Drag the bottom of the opacity curve (bottom of the trapezoid) horizontally to adjust the WL.

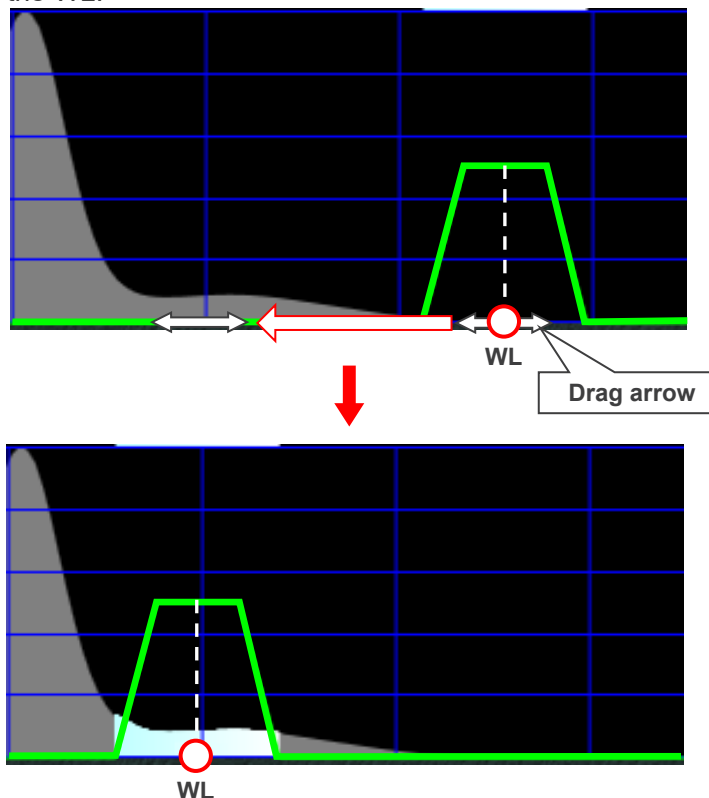

* Arrows appear when you drag the bottom of the opacity curve.

3-3) Drag the end of the top of the opacity curve up or down to adjust the opacity.

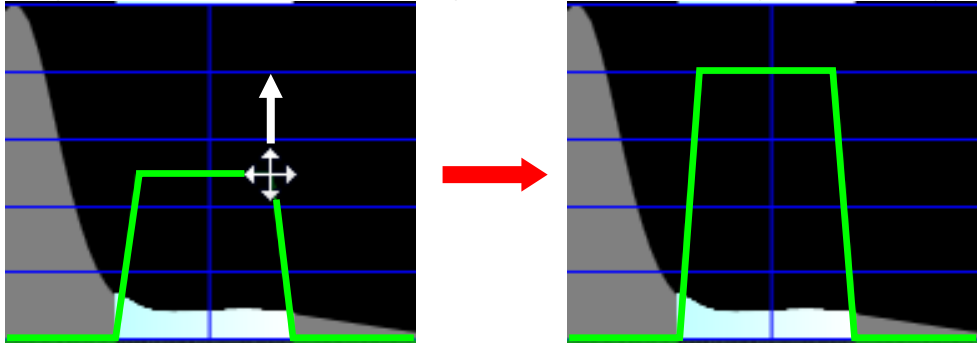

4) Register the name and color of the volume of interest.

4-1) Double-click "New VOI 0" in the "VOI" list.



4-2) Enter the name and color and then click the OK button. Do this is the same way as for the 1st VOI.

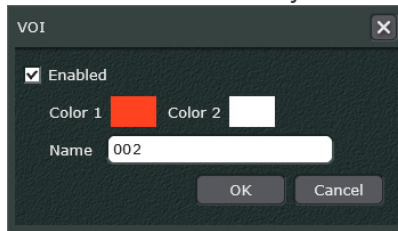

5. The 2nd volume of interest will be displayed. The opacity curve will also be displayed.

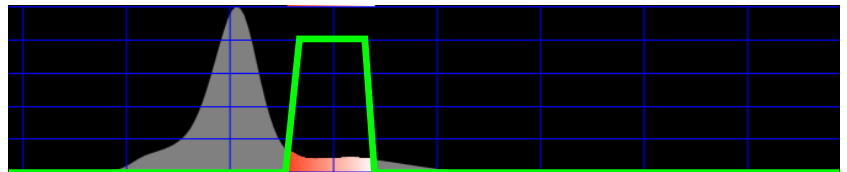
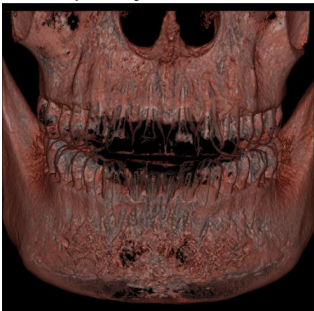

6. Display the 1st volume of interest

1) Double click the name "001" of the 1st VOI. in the VOI list.



2) Put a check in the "Enabled" box and then click the OK button.

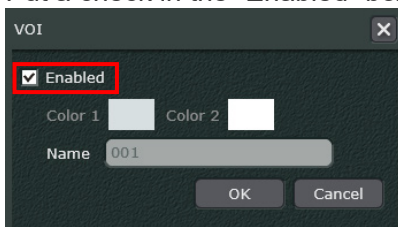

7. Both volumes of interest will be displayed.
Both opacity curves will also be displayed.

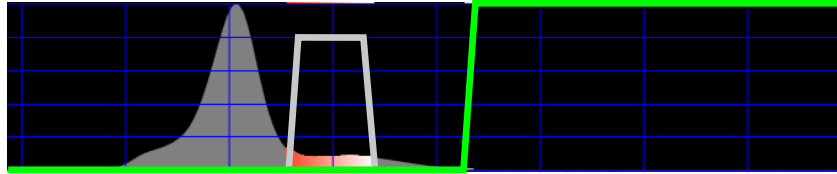

If necessary, set the display priority order.
Select which volume of interest will be on top.



Click the Up button (**up**) to move it up.

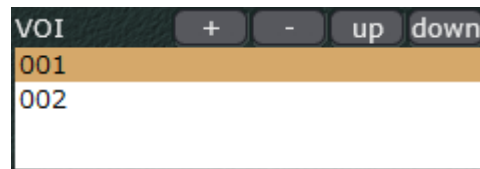
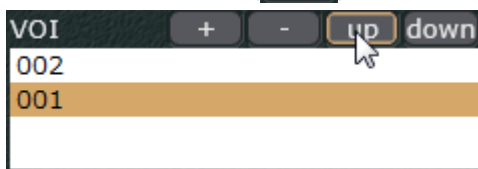

Apply Preset Adjustments, Set Default Adjustments

Click the Presets button () to show the below information.

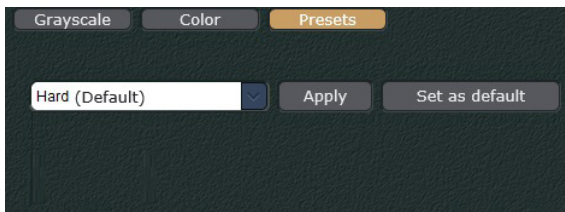

You can apply the preset adjustments for the CT images shown in the 3D Viewer.

1. Select desired preset adjustments from the pull-down menu.

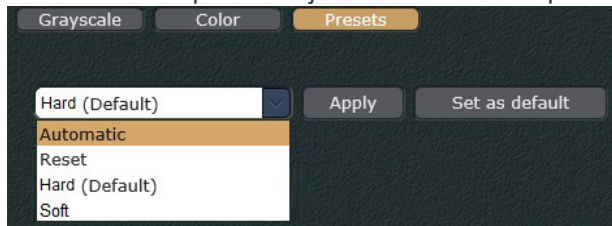

2. Click the Apply button (). The CT images will be adjusted.

Example: Apply the “Automatic” preset adjustment

Before

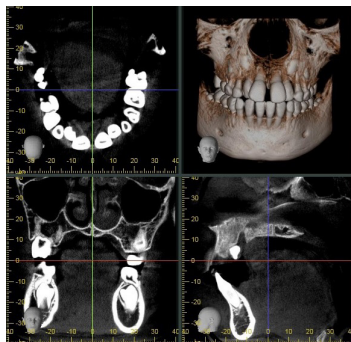

After

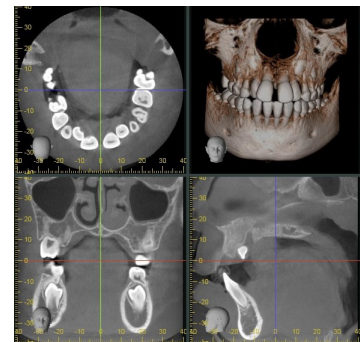

Also, you can select the default preset adjustment for CT images that will be applied automatically when selecting the thumbnail image to display CT images in the 3D Viewer.

1. Select desired preset adjustments from the pull-down menu.

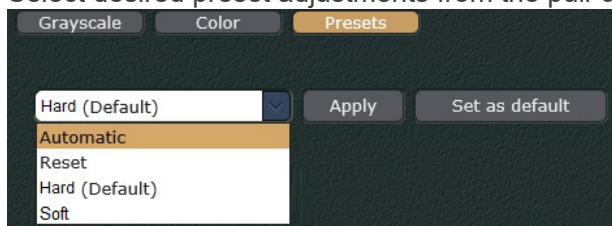

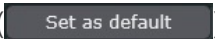
2. Click the Set as default button ().
Check “(Default)” is added next to the desired preset adjustment's name.

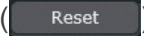

- * Presets registered in the i-Dixel computer will be listed in the pull-down menu.
- * Presets “Automatic” and “Reset” are initially installed on the i-Dixel WEB. Applying “Automatic” will adjust the images with the same adjustments as clicking the Auto button () described on “CT Slice Image Quality Adjustment” (p. 147). As for applying “Reset”, it will adjust the images with the same adjustments as clicking the Reset button () described on the same page and section.

Display X, Y, and Z Planes

Click this button () to display or hide the X, Y, and Z planes on the volume rendered image.

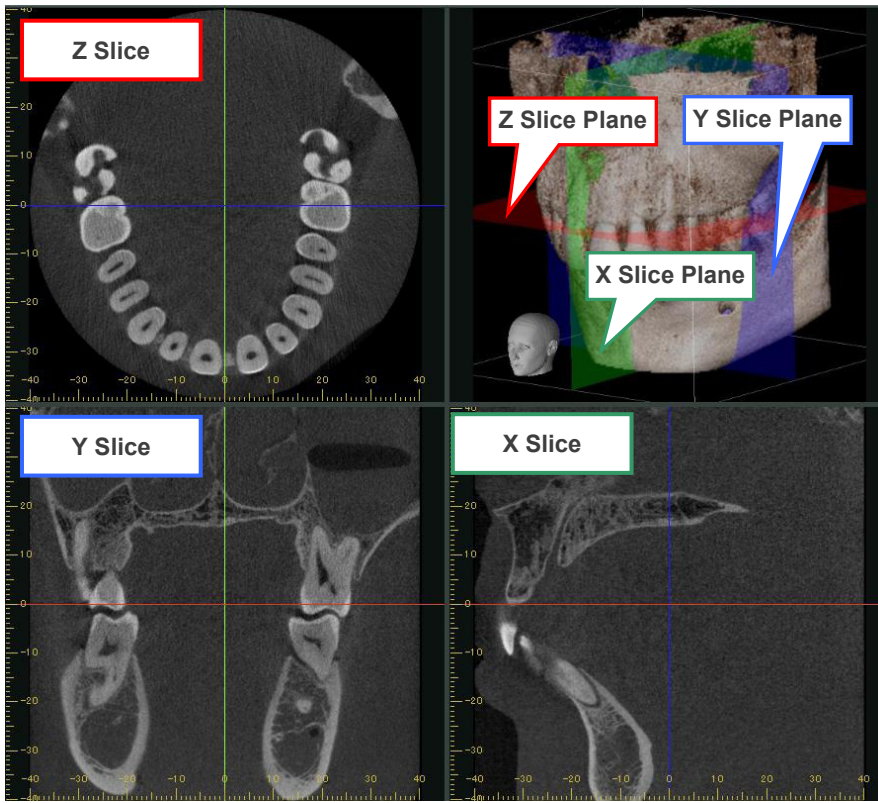

If you drag an X, Y, or Z cursor line, the corresponding plane in the volume rendered image will shift accordingly.

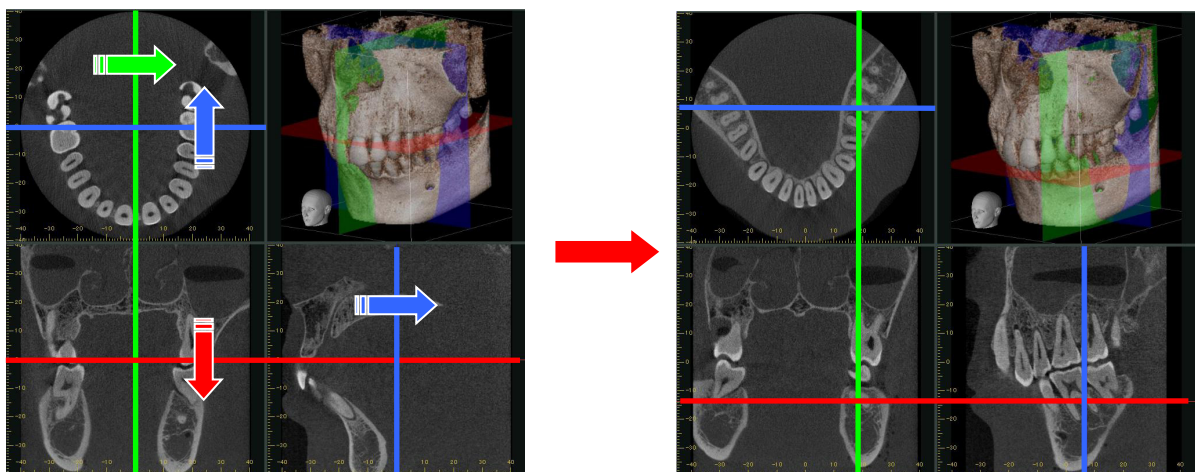

* Rotating and adjusting the magnification of the volume-rendered image may make it easier to see the cursors for the X, Y, and Z planes.

12.1.3. Tools

Use the mouse to adjust image quality.

Click or drag on a CT slice image to move the X, Y, or Z cursor lines.

Draw rectangles or straight lines. Cut images.



Select to finish drawing an object.

Select or move an object after clicking this button.

Select to stop using some other tool.

* No other button can be selected at the same time.



Click this button to adjust the brightness or contrast for CT slice images by dragging the mouse or to adjust the WL (window level) or WW (window width) for volume rendered images.

See “Adjust Brightness and Contrast for CT Slices” (p. 163) and

“Adjust WL and WW for Volume Rendered Images” (p. 164).



When this button is selected, you can click to move the cursor lines.

See “Click to Move Cursor Lines” (p. 166).

Volume rendered images can be moved by dragging; follow the instructions titled “Move a Volume Rendered Image” (p. 122).



If you click this button, you can move cursor lines for slice images by dragging on the image with the mouse.

See “Drag to Move Cursor Lines for CT Slice Images” (p. 167).

Volume rendered images may be enlarged or shrunk by dragging up or down on them; follow the instructions titled “Enlarge or Shrink Volume Rendered Images” (p. 122).



Delete a draw object.



Measure a straight line on CT slices, panoramic images, and cross sections. Make measurements as explained on “Length Measurement” (p. 84). For details on panoramic and cross section images see “Make panoramic and cross section images” (p. 128), “Make a pair of panoramic and cross section images” (p. 143).

⚠ Warning

- ***Note that length measurements will be slightly erroneous due to the principles for X-ray exposures etc. This must be taken into consideration to obtain accurate measurements. For detail see “17.1. Cautionary remarks for distance measurements” (p. 223).***



Measure angles on CT slices, panoramic images, and cross sections. Measurements angles as explained on “Angle Measurement” (p. 87). For details on cross section images see “Make panoramic and cross section images” (p. 128), “Make a pair of panoramic and cross section images” (p. 143).



Enter text.



Cut images. For details see “Cut Images” (p. 168).



Draw rectangle.



Draw polygon.



Draw straight line. Drawing with the Shift key pressed draws a horizontal or vertical line.



Free hand drawing.



Draw oval.



Draw arrows. Drawing with the Shift key pressed draws a horizontal or vertical arrow.



Draw the cMPR spline on the Z slice image to make panoramic and cross section images.
For details see “Make panoramic and cross section images” (p. 128), “Make a pair of panoramic and cross section images” (p. 143).



Draw neural tube.
For details, see “Drawing Neural Tube” (p. 170).



Draw implants.
For details, see “Drawing Implant” (p. 174).



Draw a horizontal or vertical line.

Adjust Brightness and Contrast for CT Slices

Adjust brightness and contrast in the following way.

Brightness

Click this button ().

Drag up to increase brightness and down to decrease it. Repeat, if necessary.

Example: Increase Brightness

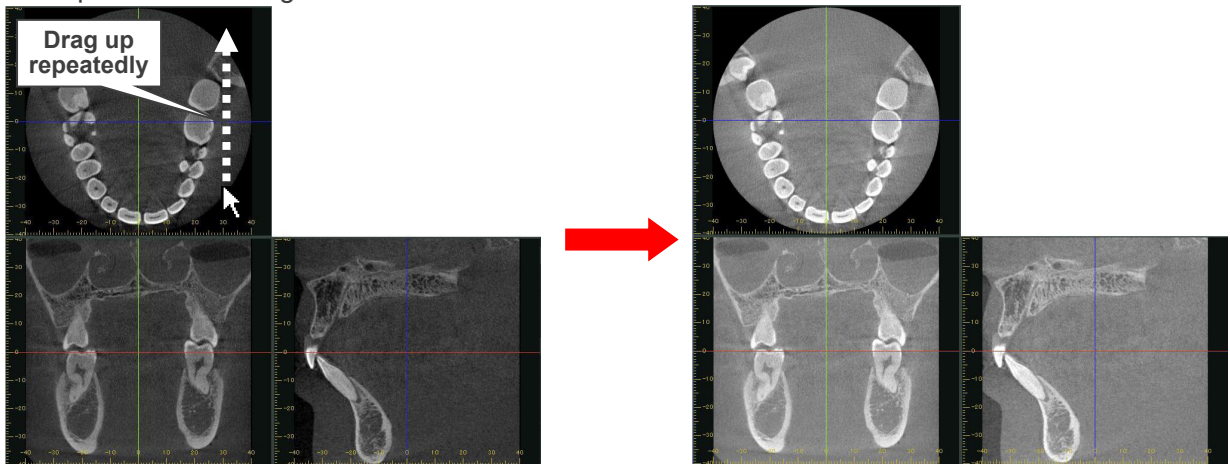



Contrast

Click this button ().

Drag left to decrease contrast and right to increase it. Repeat, if necessary.

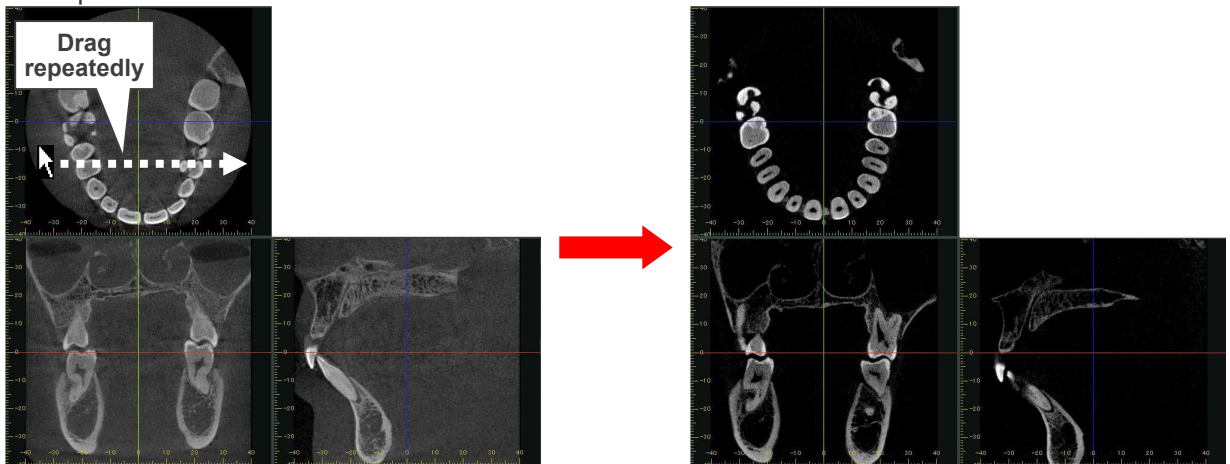
Example: Increase Contrast



* For computers to which the mouse is connected, you can adjust the brightness and contrast for CT slice images by simply dragging up, down, right, or left with the right mouse button held down without click the button ().

Adjust WL and WW for Volume Rendered Images

Adjust the WL (Window Level) or WW (Window Width) for volume rendered images in the following way.

WL (Window Level)

Click this button ().

Dragging up repeatedly on the image will raise the WL (window level) and dragging down will lower it. Repeat, if necessary. For example, increase the WL (Window Level) to display only the dental arch.

Example: Increase WL (Window Level)



WW (Window Width)

Click this button (). Drag right to expand the WW (Window Width) and left to reduce it. Repeat, if necessary.

For example, reduce the WW (Window Width) to get a sharper, clearer image of the dental arch.

Example: Reduce the WW (Window Width)

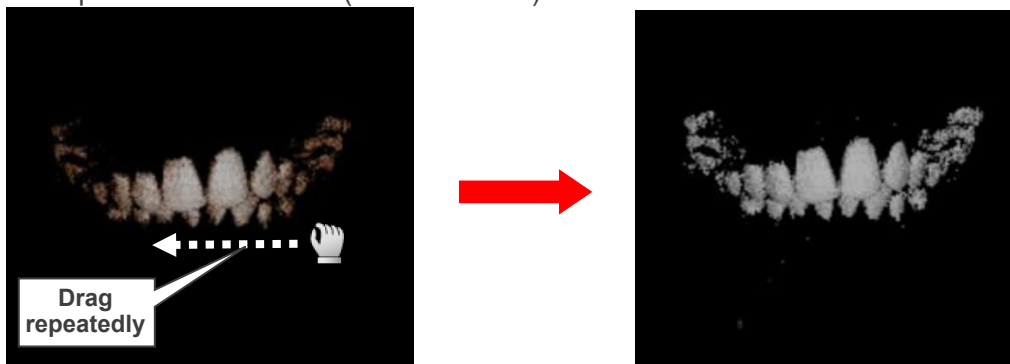

Adjust WL and WW for display of multiple volumes of interest for volume rendered images

See “Example: Multiple volumes of interest” (p. 151) for how to display multiple volumes of interest for volume rendered images.

By setting the display order priority for volumes of interest, multiple volumes of interest can be displayed simultaneously.

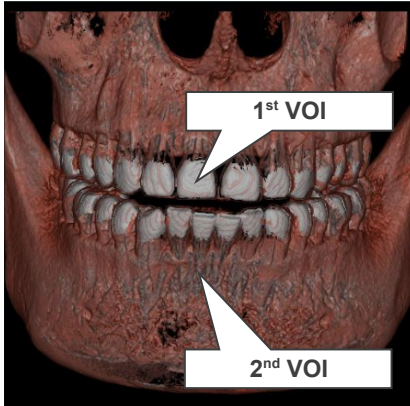

* In the above image, the 1st VOI is on top.

For volume rendered images displaying multiple volumes of interest, the WL and WW can be adjusted only for the one on top.

In the above image, the WL and WW can be adjusted only for the 1st volume of interest.

Click to Move Cursor Lines

Click this button () and you can now move the cursor lines by clicking on the image.

Example: Move cursor lines to lower left tooth no. 3.

1. Click this button ().
2. Click on the lower left tooth no. 3.
The cursor lines all line up with the lower left tooth no. 3 and slice images change accordingly.

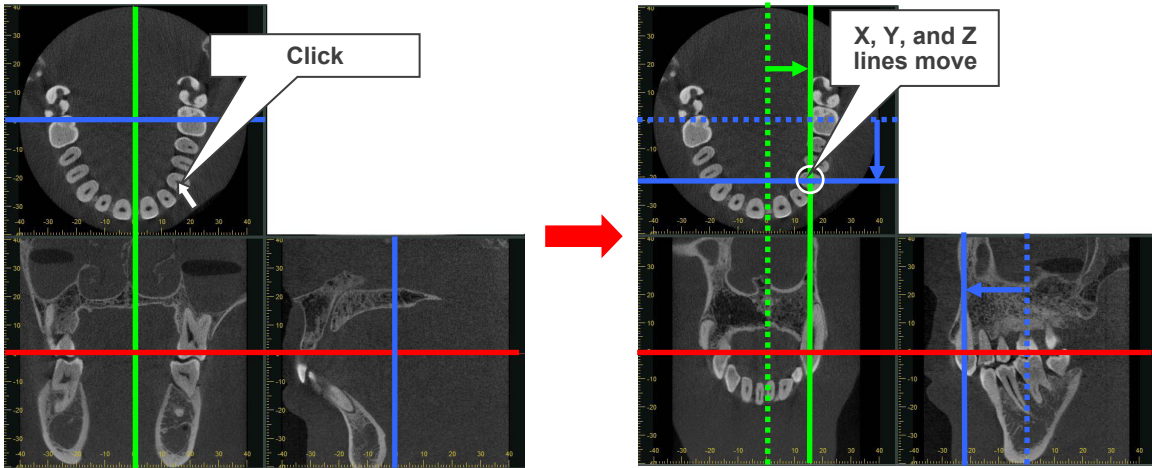

Drag to Move Cursor Lines for CT Slice Images

Click this button () and you can now move the cursor lines in the CT slice images by dragging anywhere on the image.

Example: Move X cursor line (X plane) to the left

1. Click this button ()
2. Drag the mouse cursor on the X slice image. The shape of the mouse cursor will change as shown below.



3. Drag down on the X slice image. In the example below, dragging down moves the X cursor line to the left and the X slice image changes accordingly.

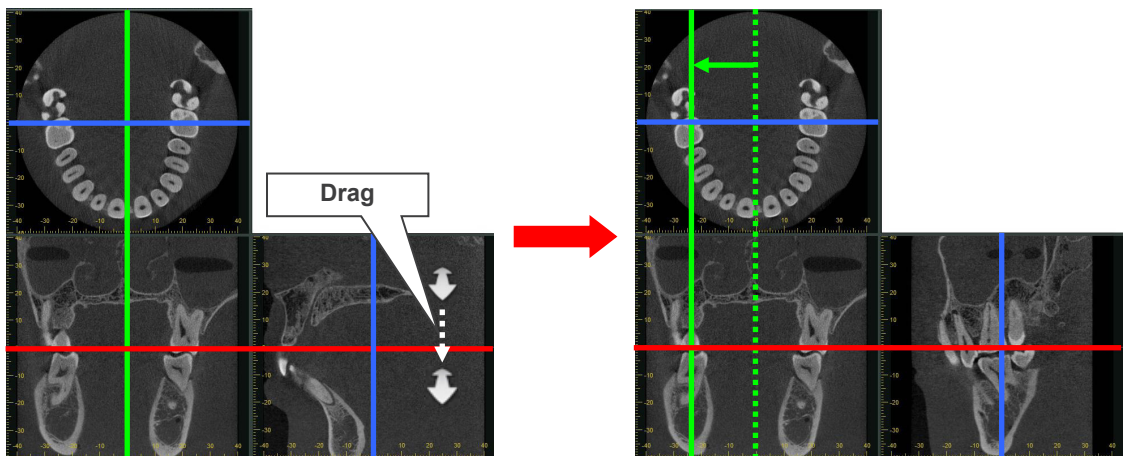

Cut Images

CT slices, panoramic and cross section images made as explained on “Make panoramic and cross section images” (p. 128) and “Make a pair of panoramic and cross section images” (p. 143) and volume rendered images can be cut.

This can be effective for removing artifacts etc.

When an image is cut all the other images in the 3D viewer will be cut simultaneously.

Example: Cut the lower, right tooth 6 in a volume rendered image.

* In this example, to make the lower, right tooth 6 easier to see, the X, Y, and Z cursors were lined up with it, and after cutting along the Z cursor, the image was rotated forwards and down.

1. Click the Cut button ().
2. Place the mouse pointer on the lower, right tooth 6 in the volume rendered image. The mouse point will change into a handpiece symbol.

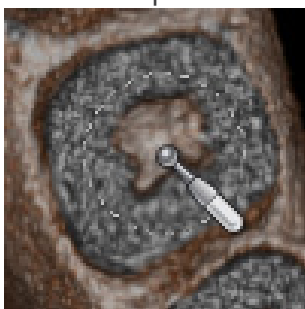

Double-click with the right mouse button to cut the image.

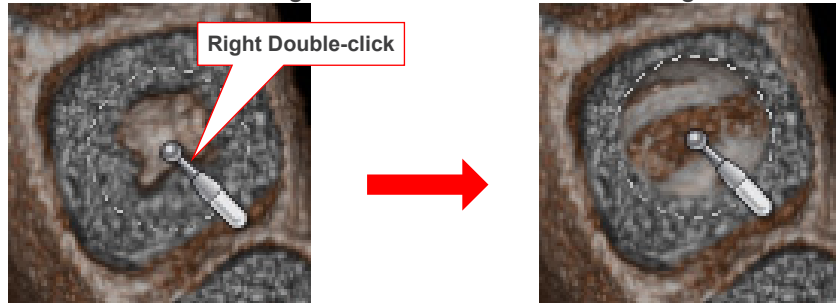

The cut will be immediately shown in the slice images.

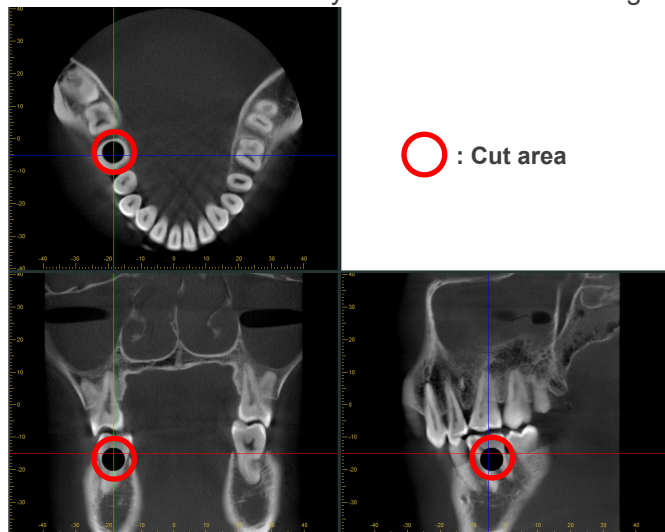

Right double click again to make the cut deeper.

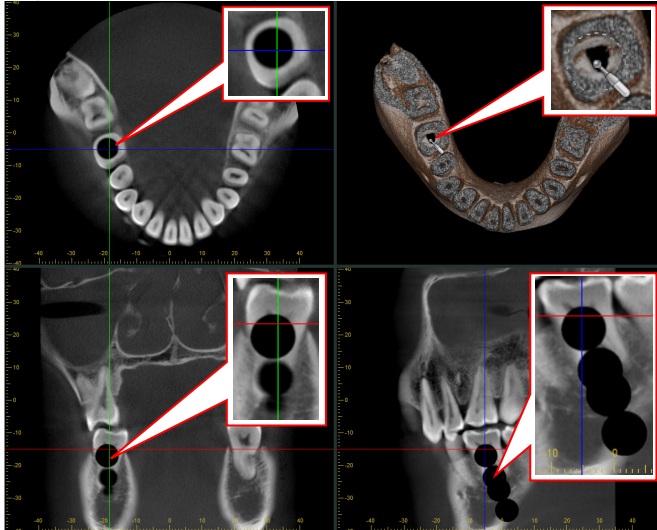

3. Click the Select button () to terminate the cutting function.

Change cutting area

While cutting, you can change the cutting area by holding down the right button and rotating the mouse wheel.

After changing the area, right double-click to continue cutting in the new area.

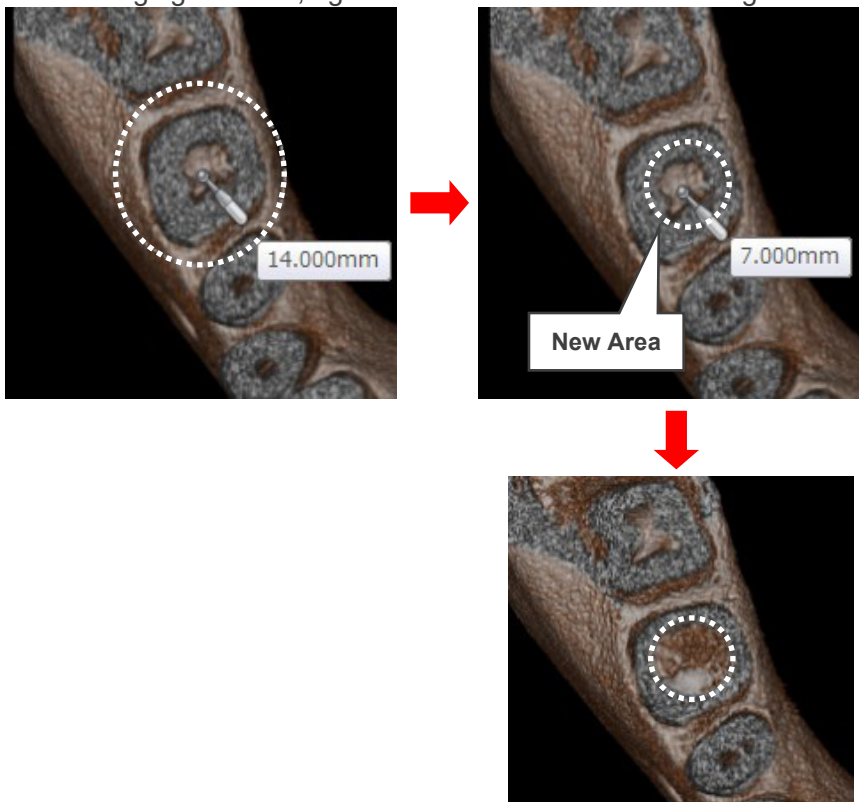

Cancel Cut

While cutting hold down the Ctrl key and right click to cancel the last cut; click again to cancel the one before that etc.

Drawing Neural Tube

You can draw a neural tube in a CT slice image by plotting the points of the neural tube.

- * Neural tubes cannot be drawn in panoramic images, cross section images, and volume rendered images. A neural tube drawn in the CT slice image will be reflected into the volume rendered image.

1. Right-click the CT slice image, and then select “Thickness”. Set the thickness for less than 1.0 mm.

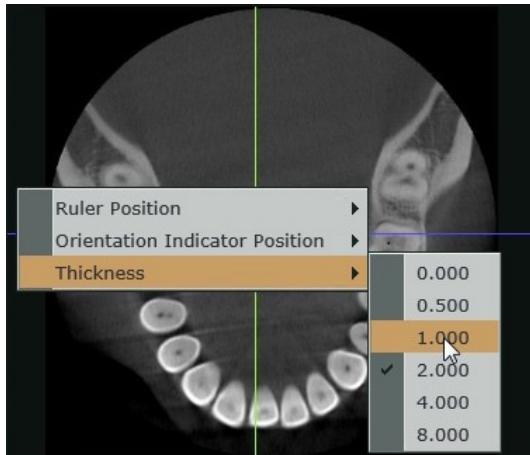

- * If the thickness is over 1.0 mm, a neural tube cannot be drawn.

2. Change the CT slice image to the appropriate one for drawing the neural tube. Adjust the rotation of the CT slice image to an appropriate angle for drawing the neural tube.

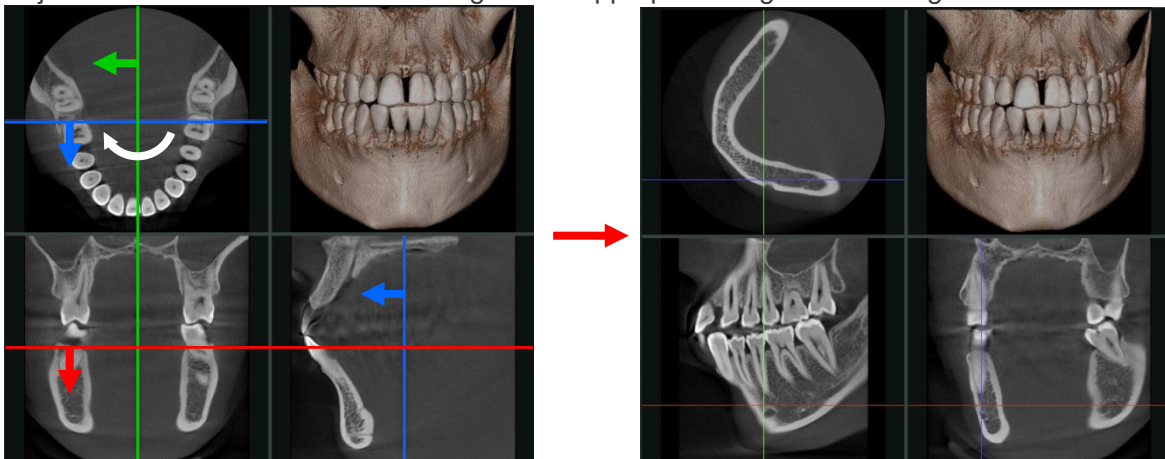

- * You can change the CT slice image. For details, see “Change CT Slice Images” (p. 119). You can adjust the rotation of the CT slice image. For details, see “Rotate CT Slice Images” (p. 119).

3. If necessary, adjust the direction of the volume rendered image so that you can see the neural tube.

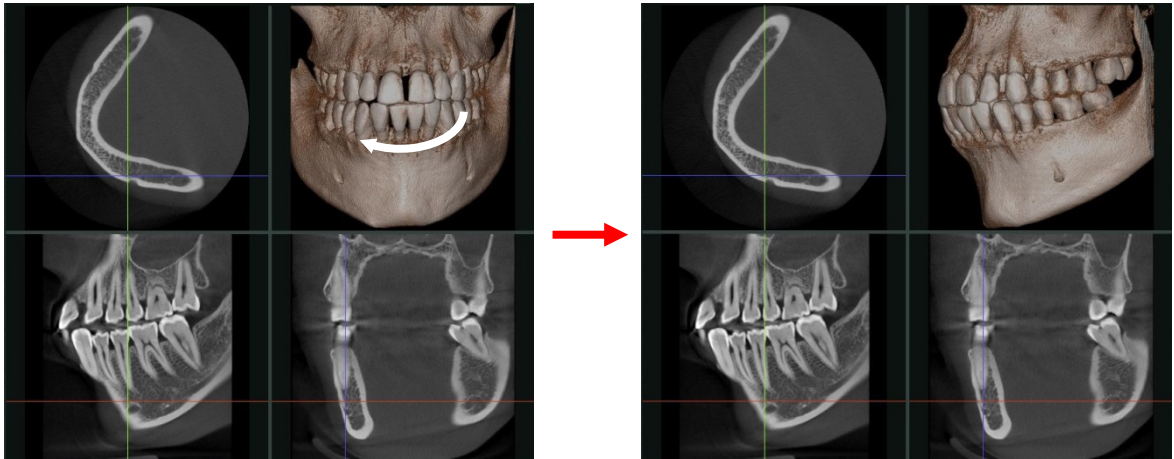

* You can adjust the direction of the volume rendered image. For details, see “Rotate CT Slice Images” (p. 119).

4. Click “Tools” in the toolbox, and then click the Draw Neural Tube button ().

5. Move the mouse pointer to the starting point of the neural tube. Right-click and start plotting.

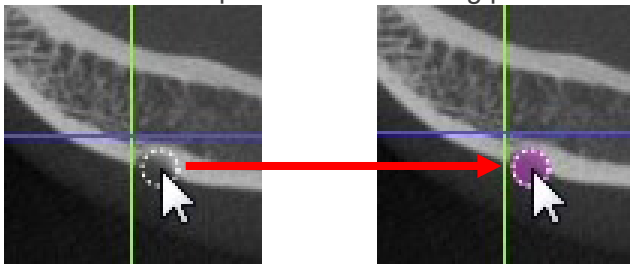

6. Repeat right-clicking until the end of the neural tube. Each time you right-click a point, the neural tube will be plotting and connected to the previous point.

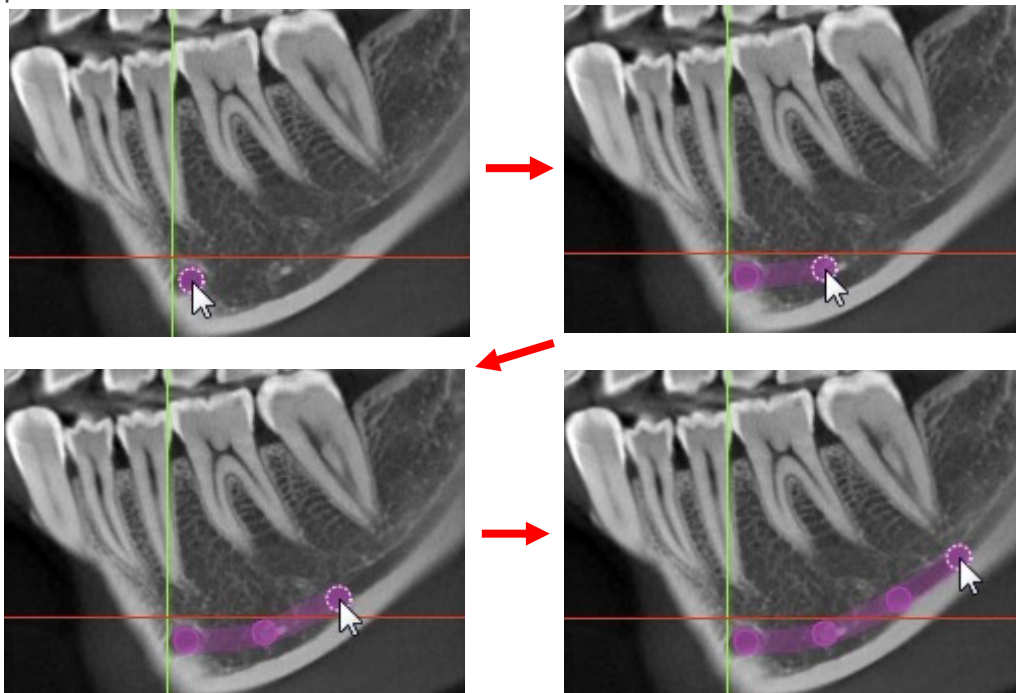

7. Click “Tools” in the toolbox, and then click the Select button () to finish drawing. You can see the neural tube in the axial images and volume rendered image.

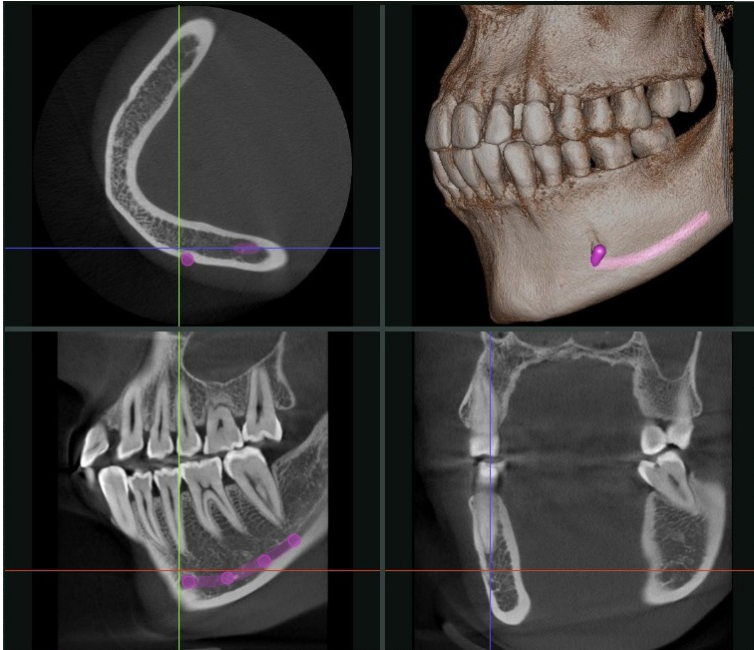

When you finish drawing the neural tube, one item will be added to the annotations list.

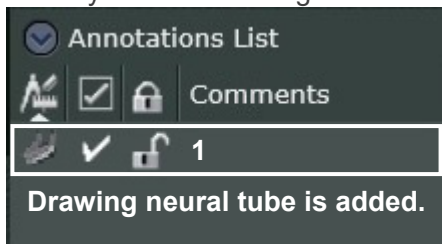

* For details of the annotations list, see “12.1.6. Annotations List” (p. 184).

Supplemental Remarks to Drawing Neural Tube

- Deleting the Neural Tube

To delete the neural tube, right-click any of the drawing points and then select "Erase".

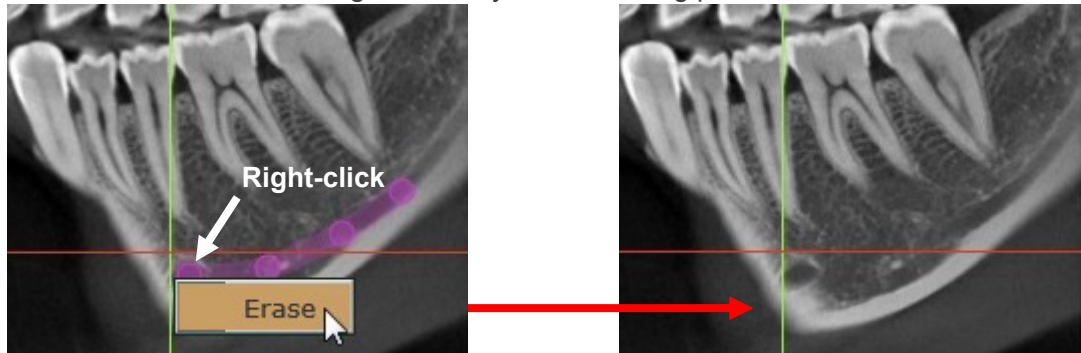

- Redrawing the Neural Tube

You can select any drawing point and drag it to edit the neural tube.

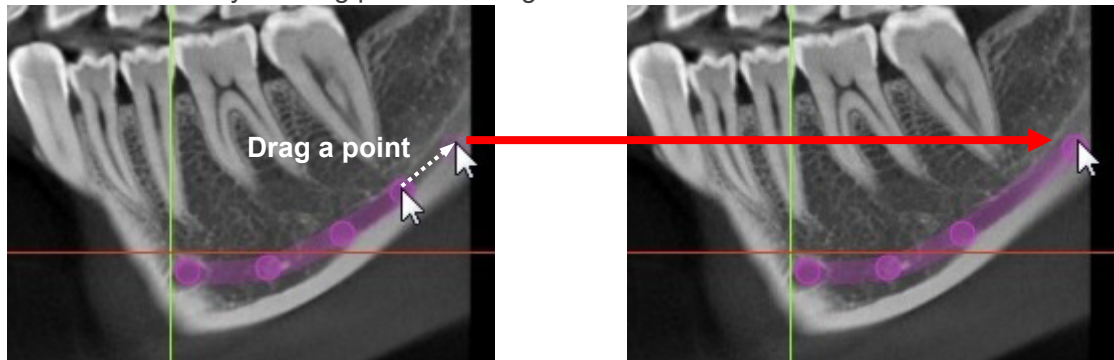

Drawing Implant

You can draw implants in a CT slice image.

- * Implants cannot be drawn in panoramic images, cross section images, and volume rendered images. Implants drawn in the CT slice image will be reflected into volume rendered images

⚠ Warning

- **Drawing implants in the i-Dixel WEB is intended for using in presentation to explain how the implants will be implanted. Designing an operation plan and using it for actual treatment are not intended.**
- **Implant design and shape drawn in the i-Dixel WEB may differ from the actual implant models. Pay adequate attention to this point when you give a presentation.**
- **Implants that not be applied to a specific case or unpurchasable may be drawn in the i-Dixel WEB. Contact your local dealer or implant manufacturer when you actually purchase or apply implants to treatment.**
- **The user (e.g., healthcare facility, clinic, hospital, etc.) is fully responsible for giving a presentation, designing an operation plan, or therapeutic practice, which using drawn implant models in the i-Dixel WEB.**

Drawing Procedures

1. Right-click the CT slice image, and then select “Thickness”. Set the thickness for less than 1.0 mm.

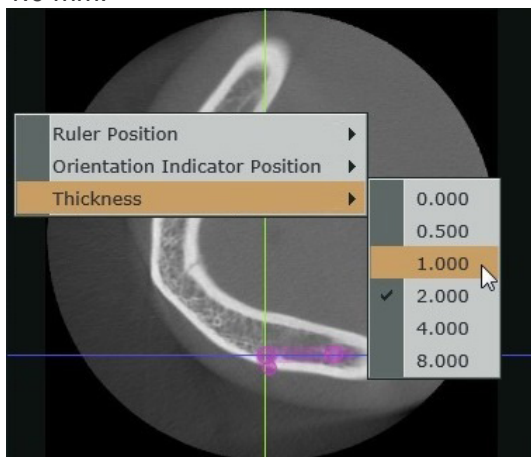

- * If the thickness is over 1.0 mm, implants cannot be drawn.

2. Change the CT slice image to the appropriate one for drawing the implant. Adjust the rotation of the CT slice image into appropriate angle for drawing the implant.

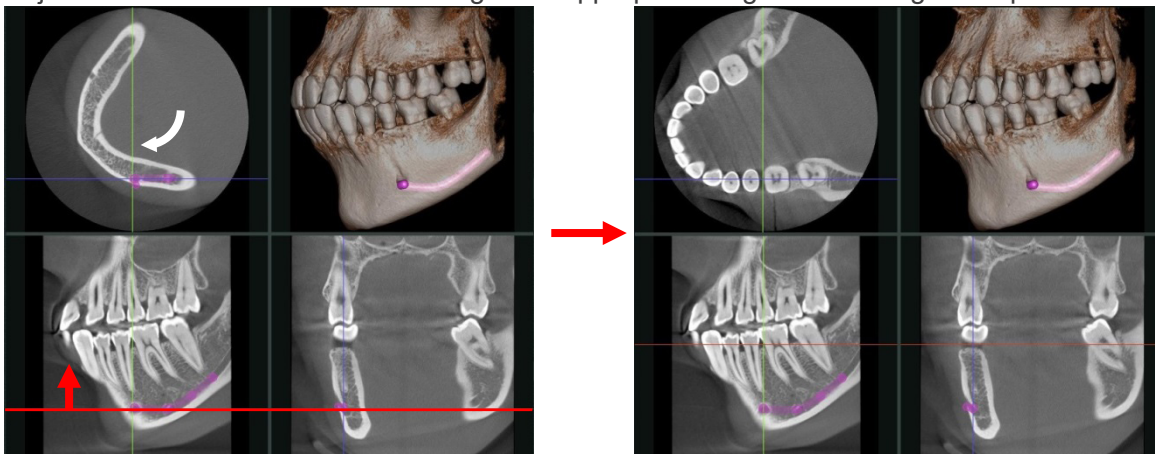

- * You can change the CT slice image. For details, see “Change CT Slice Images” (p. 119). You can adjust the rotation of the CT slice image. For details, see “Rotate CT Slice Images” (p. 119).

- Click "Tools" in the toolbox, and then click the Draw Implant button ().
- The following dialogue will appear.
Select desired implant manufacturer, series, shape, and target jaw, then click the Add button.

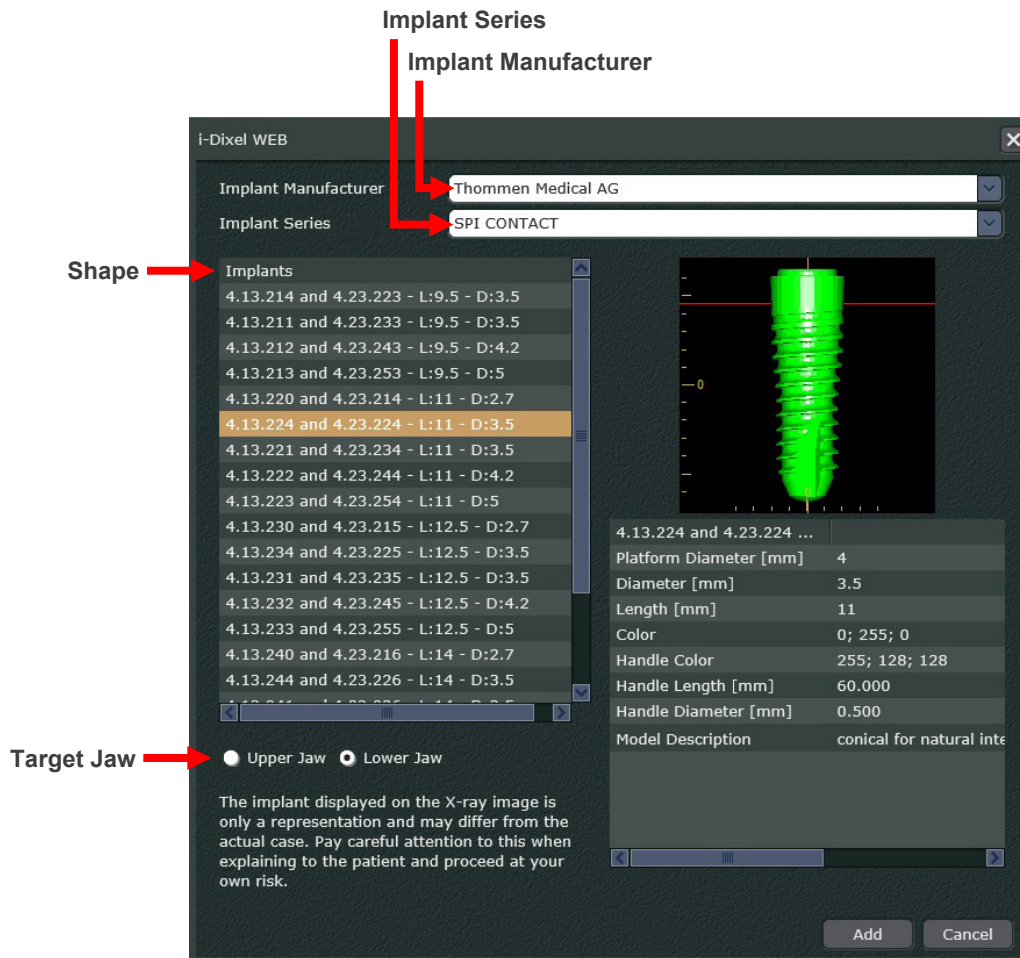

- An implant will appear in the intersection of the cursor lines.
Adjust its position and orientation as necessary.

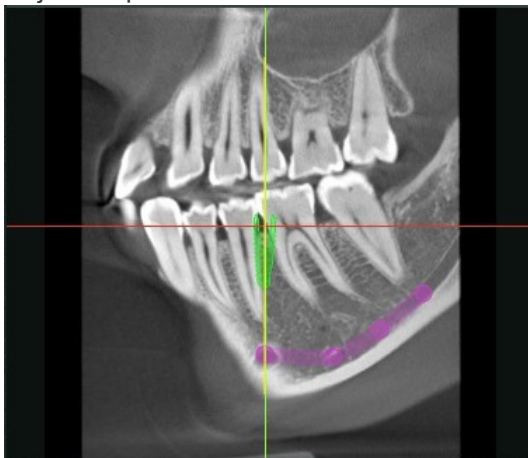

Drag the implant to adjust the position.

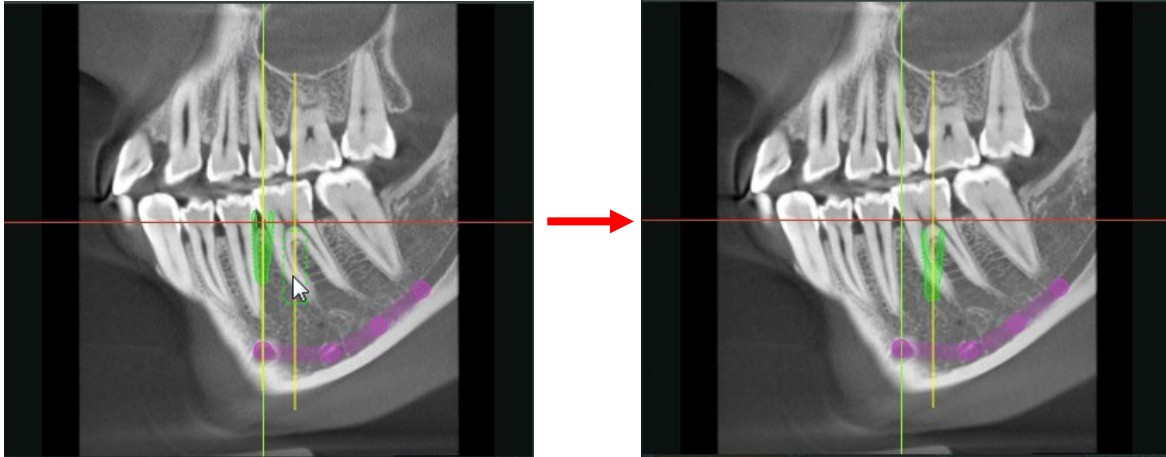

Drag the implant handle to adjust the orientation.

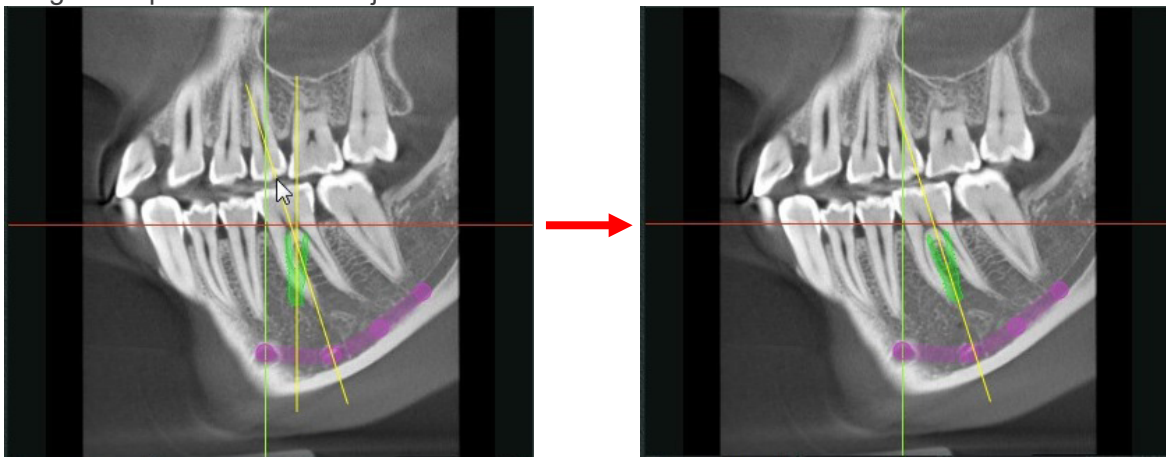

6. Click "Tools" in the toolbox, and then click the Select button () to finish drawing. You can see the implant in the axial images and volume rendered image.

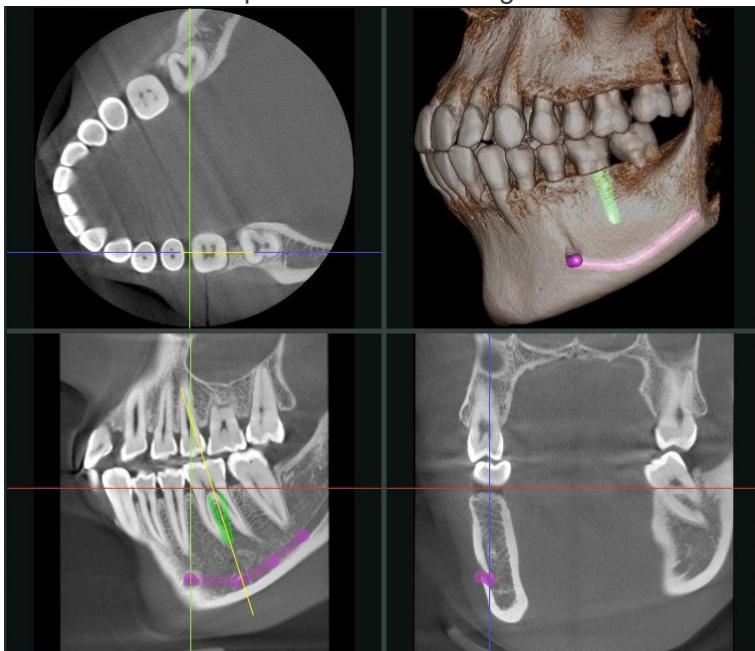

When you finish drawing an implant, one item will be added to the annotations list.

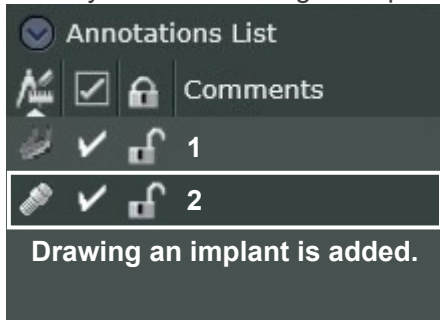

* For details of the annotations list, see “12.1.6. Annotations List” (p. 184).

Customization

You can customize drawing implant in the dialogue as described in “Drawing Procedures” (p. 174).

1. Click “Tools” in the toolbox, and then click the Draw Implant button ().
2. Click the drop-down arrow of the Implant Manufacturer, and then click “<Custom>”.

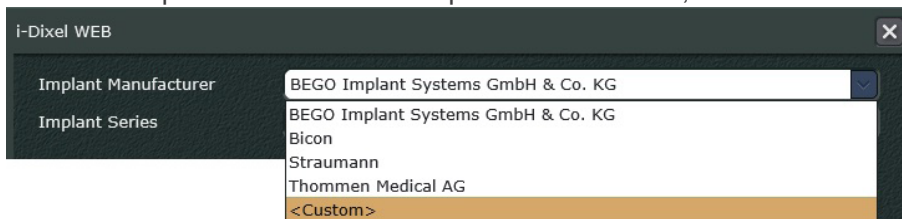

Select “<<New Custom Implant>>” from the list in Implants.

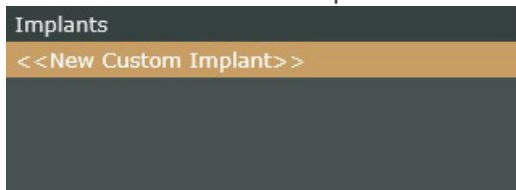

3. Select the target jaw and customize the shape. Customized Implant will be displayed in the preview area based on the input data.

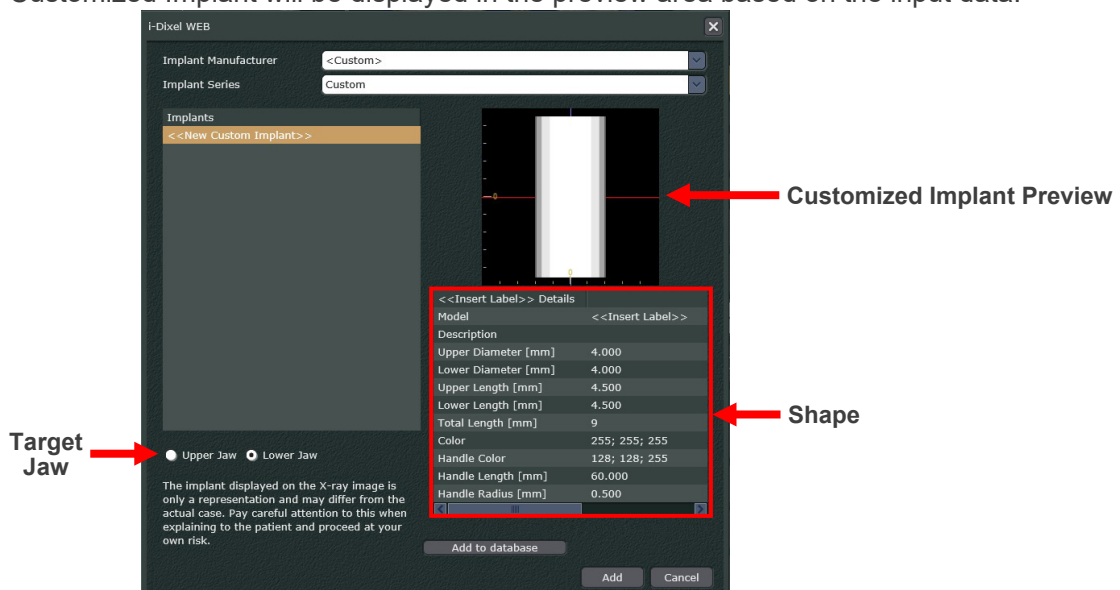

- Target Jaw
Select either “Upper Jaw” or “Lower Jaw”.

- Shape

Input information or data for items (1) through (5).

Model	Custom_001	(1)
Description		(2)
Upper Diameter [mm]	4.000	(3)
Lower Diameter [mm]	1.000	
Upper Length [mm]	6.000	
Lower Length [mm]	5.000	
Total Length [mm]	11	
Color	0; 255; 0	(4)
Handle Color	255; 128; 128	(5)
Handle Length [mm]	60.000	
Handle Radius [mm]	0.500	

(1) Type implant model name.

(2) Type additional information as necessary.

(3) Input dimension of the implant in millimeters.

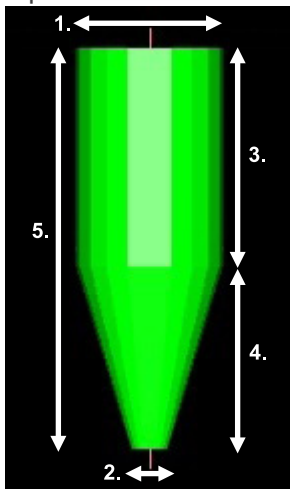

1. Upper Diameter [mm]
2. Lower Diameter [mm]
3. Upper Length [mm]
4. Lower Length [mm]
5. Total Length [mm]

(4) Set implant color in RGB color codes.

(5) Set implant handle color in RGB color codes, and input length and radius in millimeters.

4. Click the Add to database button (**Add to database**).

The customized implant will appear under the “<<New Custom Implant>>” in the list of Implants.

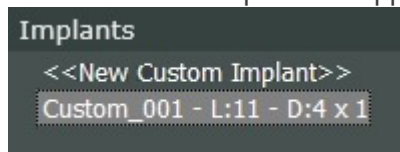

Click the Add button (**Add**) to close the dialogue.

Customized implant can be drawn as described in “Drawing Procedures” (p. 174).

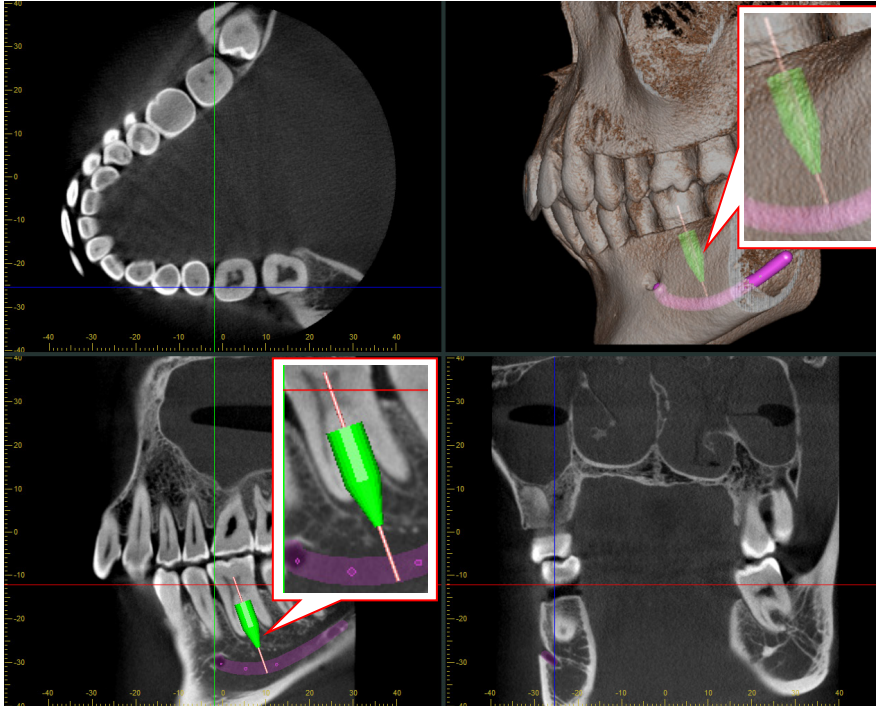

Supplemental Remarks to Drawing Customized Implant

- Deleting Implant
Right-click the implant, and then click “Erase”.

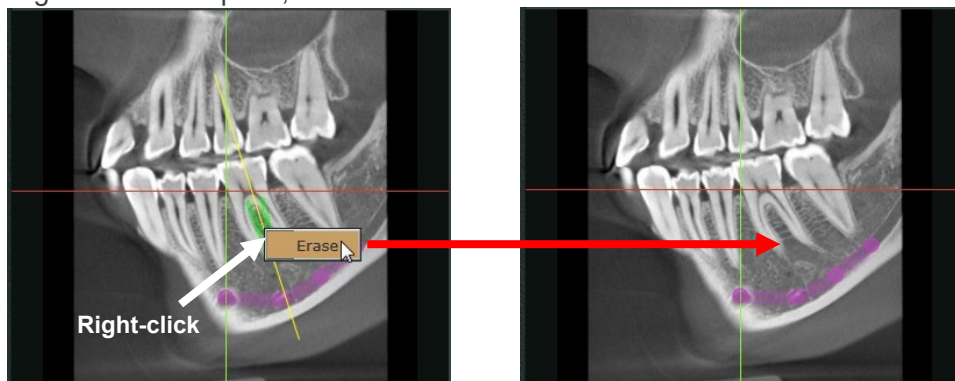

- Realign volume to show implant vertically
Double-click on an implant to automatically rotate the volume to align the implant vertically.

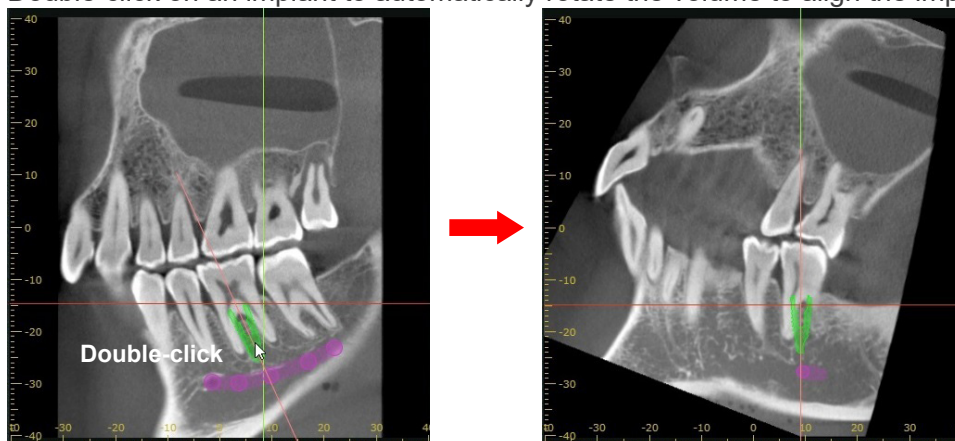

When the volume has been rotated to align the implant vertically, the X, Y, and Z cursor lines will also snap to the center of the implant.

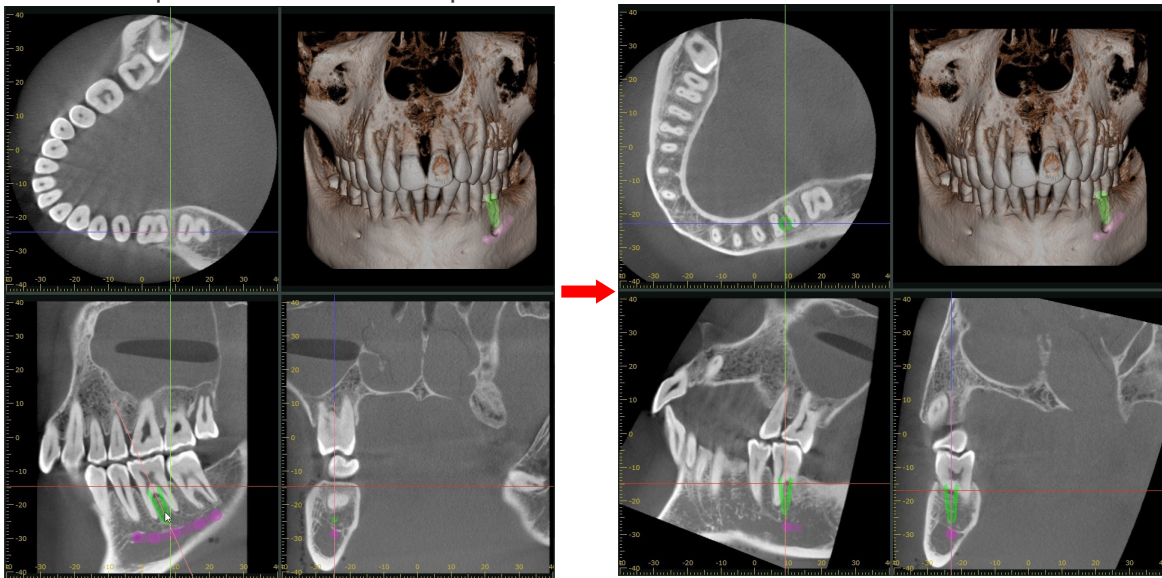

12.1.4. Attitude

The attitude (direction the image is facing) for the volume-rendered image and the slice images can be adjusted. Click any of the buttons to select the corresponding attitude.



Forwards



Backwards



Top



Bottom



90° Left



90° Right



Same direction as when CT exposure was completed



Same direction as when edited information was saved

12.1.5. Volume Cuts

Volume rendered images can be cut along the X, Y, and Z cursor planes. A maximum of 6 types of cuts can be made.

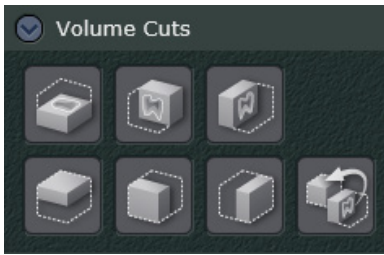

Cut above Z plane.



Cut in front of Y plane.



Cut to the right of X plane.



Cut below Z plane.



Cut behind Y plane.



Cut to the left of X plane.



Undo the cut.

The image below shows cutting off the right side of the X **plane**.

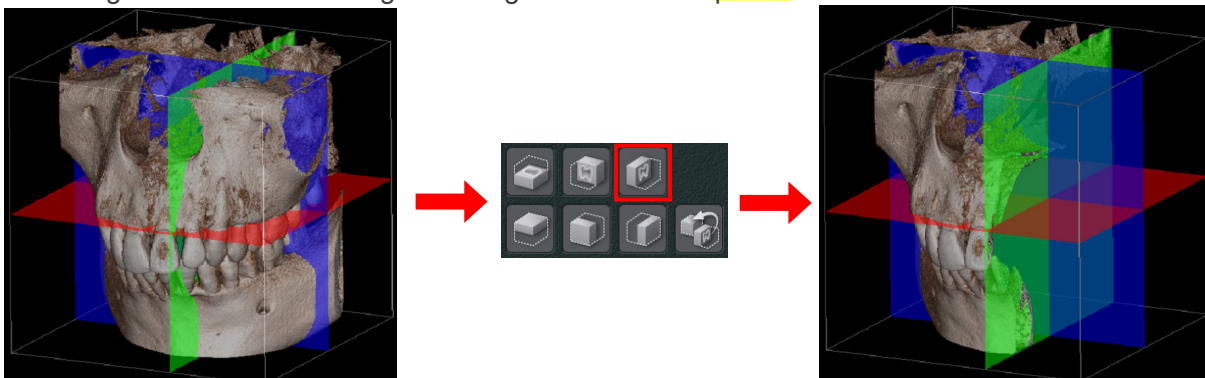

Example: Cut off the right side of the X plane cursor.

1. Line up the X cursor with the plane to be cut.

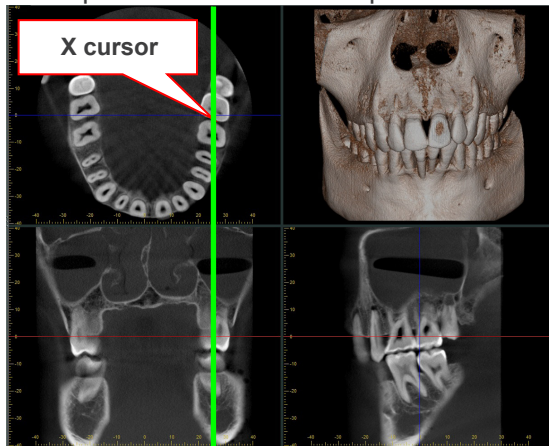

2. Click the Cut button ().

3. The right side of the X plane cursor is cut off.

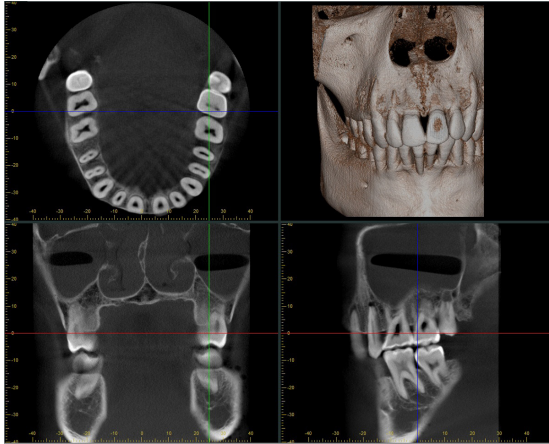

4. Rotate the image to view the cut surface.

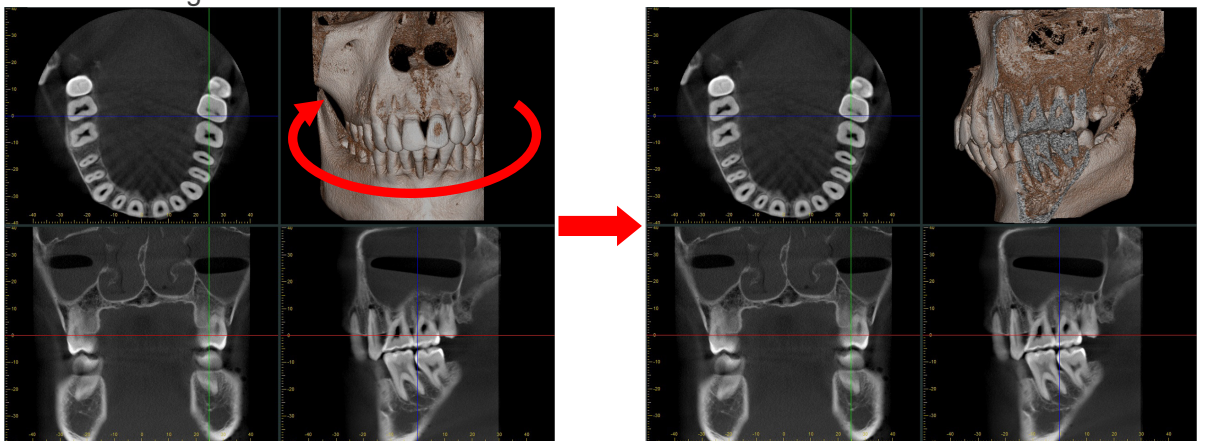

12.1.6. Annotations List

You can review the list of the drawn objects such as rectangles and lines on CT slice images, panoramic images, and cross-sectional images. Right-click on a drawn object in the list and select "Edit" to display the following dialogs.

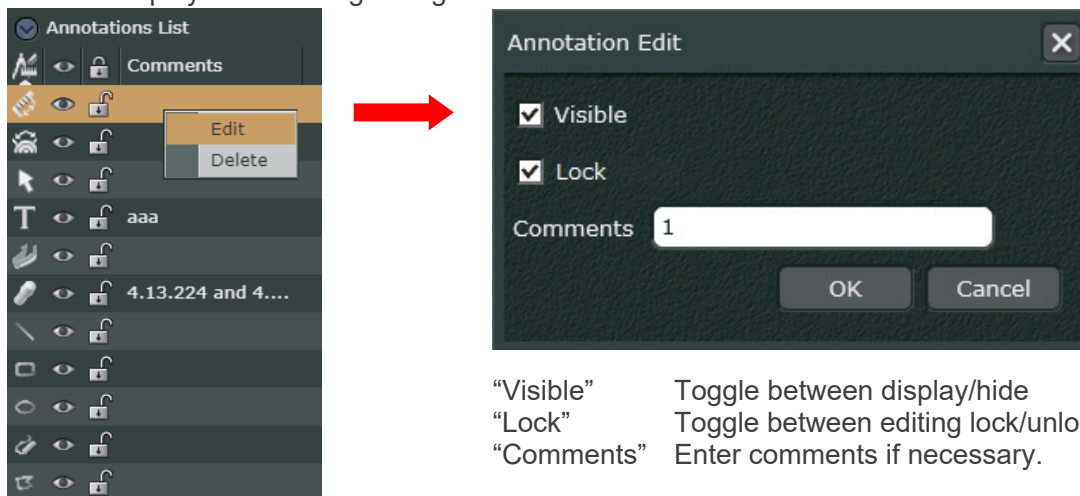

"Visible" Toggle between display/hide
 "Lock" Toggle between editing lock/unlock
 "Comments" Enter comments if necessary.

[Toggle between display/hide all annotations]

You can display or hide all items by clicking on .

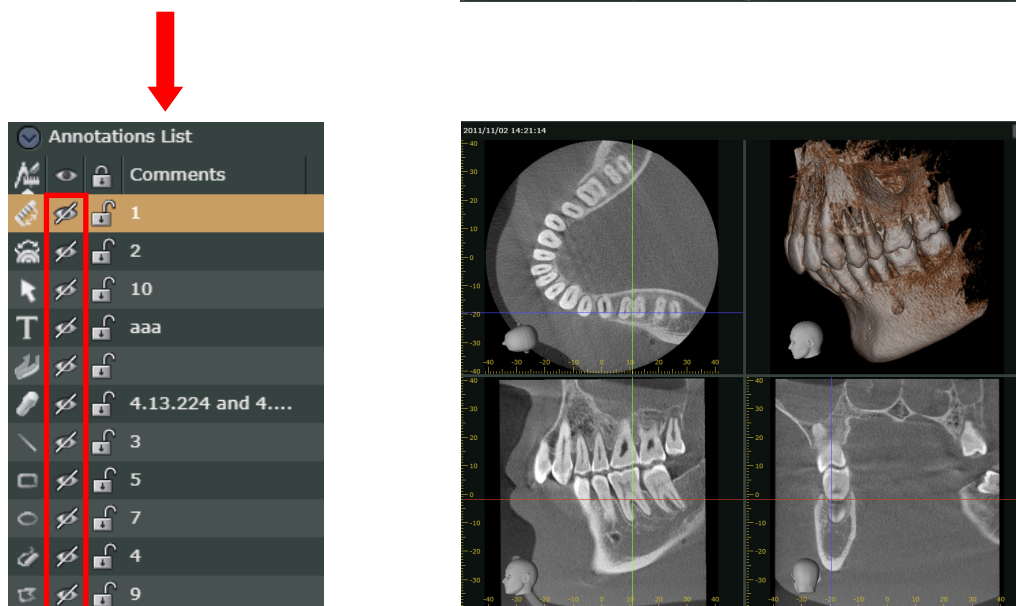
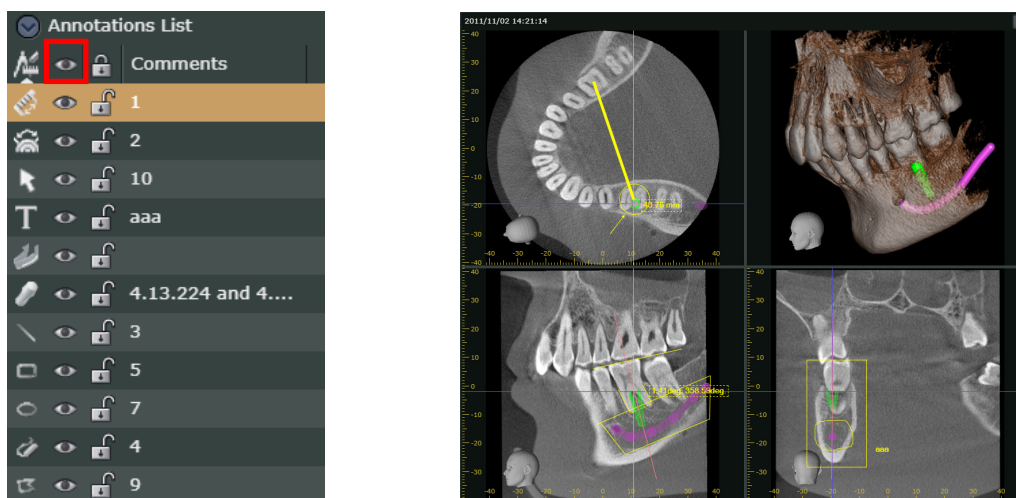

[Sort annotation types]

You can sort the drawn object by category by clicking on  .

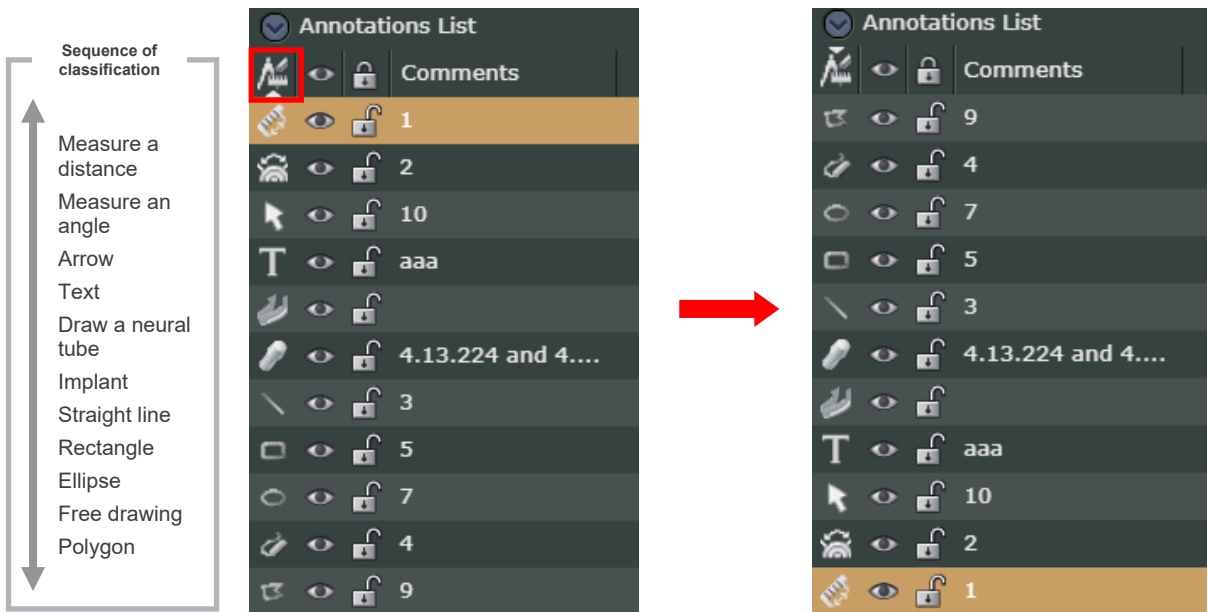

[Display or hide each item]

You can display or hide each item by clicking on  .

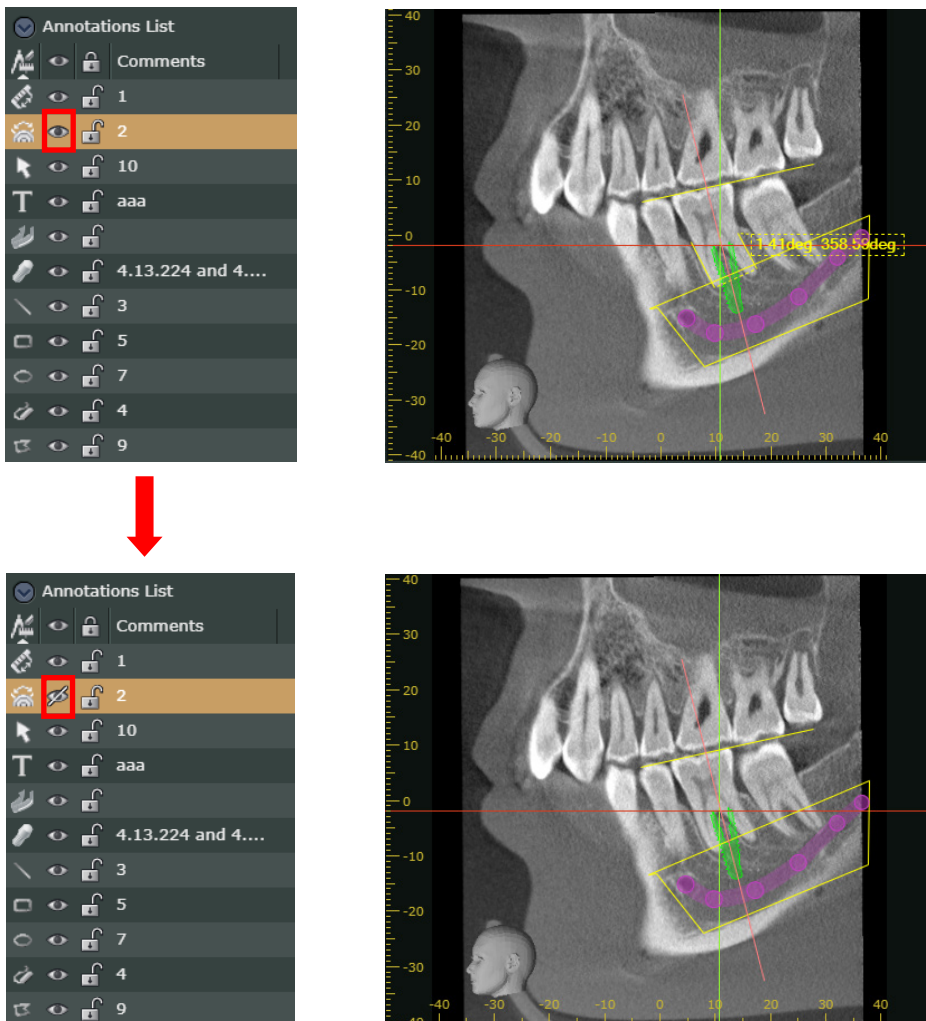

<<Example: Display only the implant annotations>>

1. You can hide all items by clicking on .

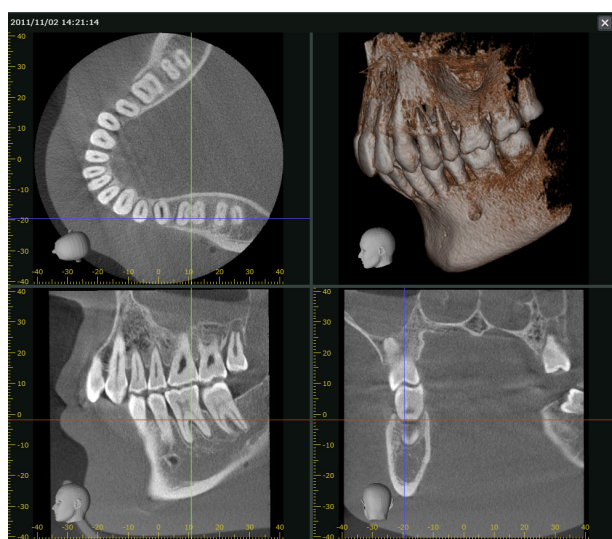
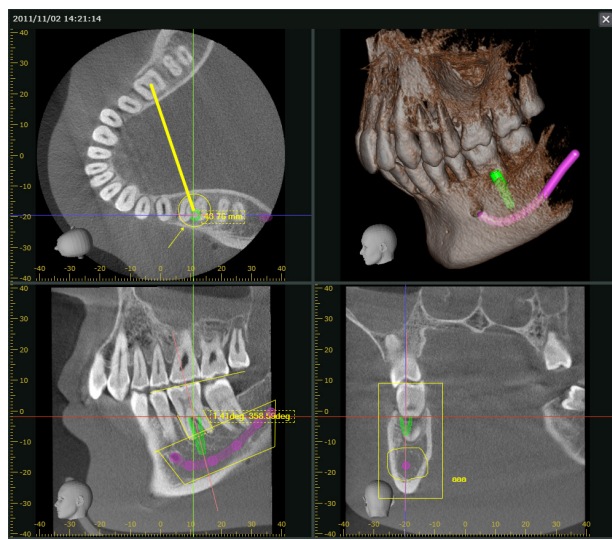

2. Click () next to the implant annotation to display it.

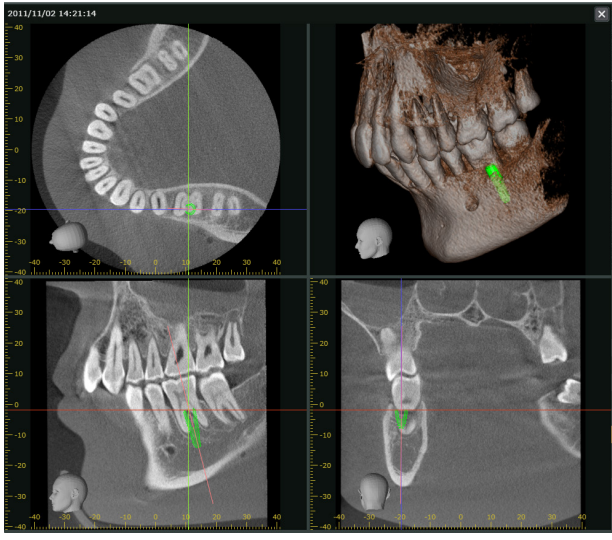
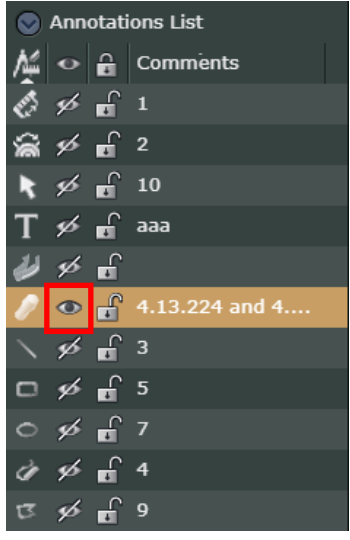

12.2. Data Panel

Check this panel for exposure conditions and reconstruction condition for CT volume data.

12.2.1. Volume Information

Exposure conditions and conditions for CT volume reconstruction are appended. If there is nothing appended, nothing will be displayed. Appended information cannot be edited. Appended information differs somewhat depending on the X-ray unit used for the exposure.

Volume Information	
CT Task ID	1.2.392.00200036.9133.3.1.900 059.3.20120919105818169
Volume ID	0
Voxel Size	0.16;0.16;0.16 mm
FOV	88.16;88.16;80.64 mm
Exp. Date	-
Tube voltage	80.0 kV
Tube current	3.0 mA
CTDIw	1.2 mGy
DAP	-
Part	ARCH
Recon. Filter	G_003+H_205
Projection Angle	-
Comments	-

12.3. Settings Panel

You can configure settings related to volume rendered image, adjust the quality of CT slice images, and panoramic images generated by CurvedMPR, and modify settings related to cross-sectional images.

12.3.1. Volume Rendering Settings

Projections and other conditions for volume rendered images can be made here.

Volume Rendering Settings	
<input checked="" type="checkbox"/>	Specular Reflection
<input type="checkbox"/>	Tomography on Cutting Plane
Sampling Pitch	
	0.5
<input type="checkbox"/>	Light Attenuation
	7
Light Blending Weight	
	0.85
<input type="radio"/>	Perspective
<input checked="" type="radio"/>	Parallel
	50
(FOV deg.)	
XYZ Planes	
	25%
Background Color	

“Specular Reflection”

If you check this box, the reflection effect in the center of the image will be enhanced.

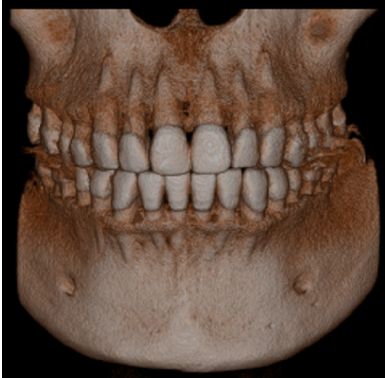

No reflection



Reflection

“Tomography on Cutting Plane”

Check this box to display the surface of a cut plane.

* See “12.1.5. Volume Cuts” (p. 182) for cutting along planes.



No cut surface image

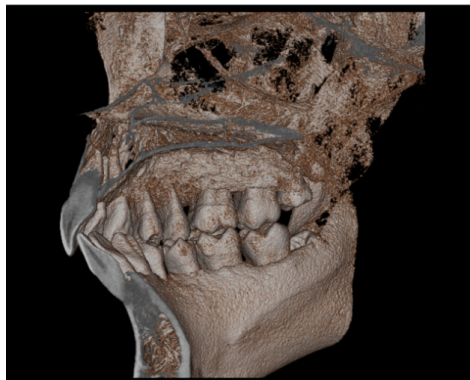

Cut surface image

“Sampling Pitch”

Move the slider to the right to increase the value.

A larger value will increase the speed for rotating images etc., however, this may produce stratified artifacts.

A smaller value will yield better image quality, but image movement will be slower.

“Light Attenuation”

Check this box and move the slider to the right to cut down on the amount of light reflected or scattered by the image.

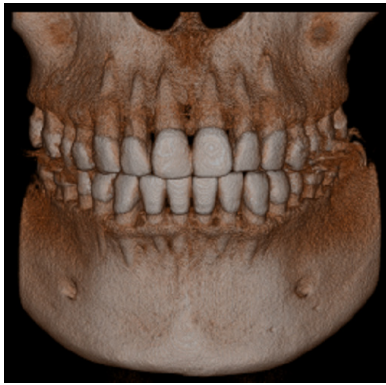

No light attenuation



Light attenuation

“Light Blending Weight”

“Light Blending Weight” refers to the ratio of ambient light and diffuse light. Move the slider to the right to increase the ratio and emphasize concavity and convexity.

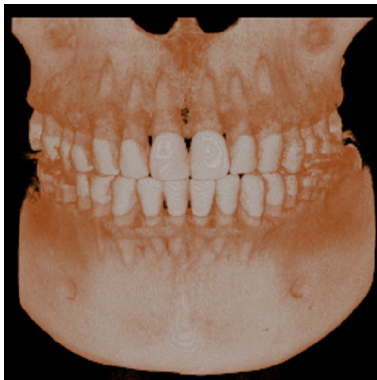

Low ratio

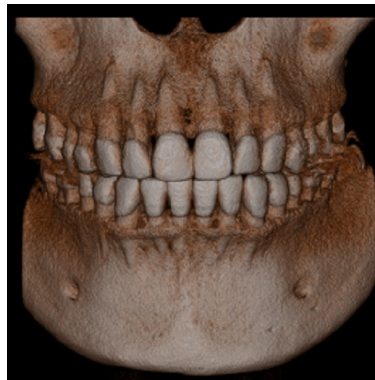

High ratio

“Perspective”, “Parallel”

Select “Perspective” or “Parallel” for the projection and display of volume rendered images. “Perspective” changes the viewing angle and distance. Move the slider to adjust the viewing angle “(FOV deg.)”.



Parallel

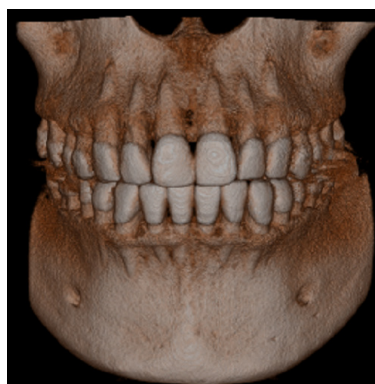

Perspective (10° angle)

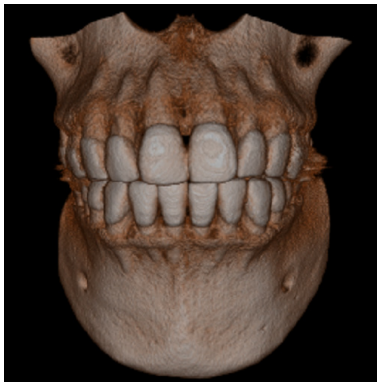

Perspective (50°angle)

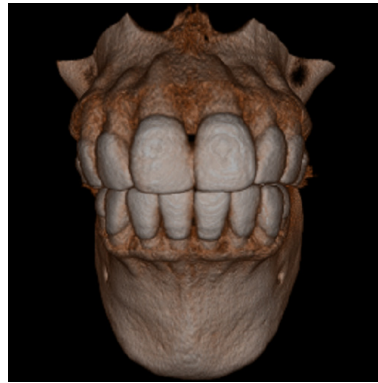

Perspective (90°angle)

“XYZ Planes”

See “Display X, Y, and Z Planes” (p. 159) for how to set the transparency for the XYZ plane cursors in the volume rendered image.

Move the slider to the left to increase the transparency of the “XYZ Planes”.

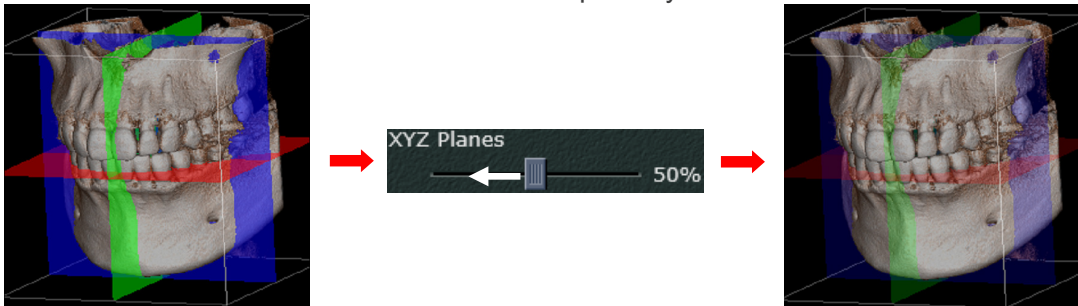

“Background Color”

Select the background color for the images.

Check the “Background Color” box to display the dialogue window and then select a color.

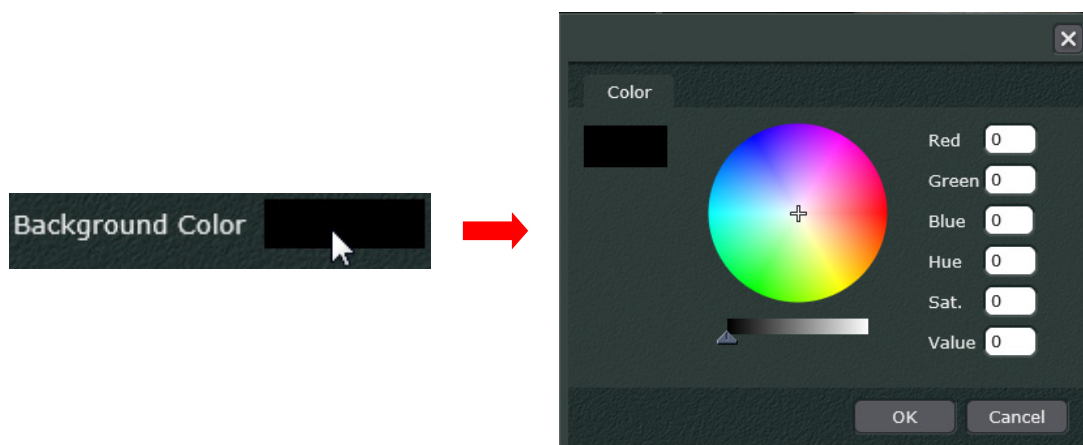

12.3.2. Slice Settings

This sets the CT slice thickness and the ruler position.

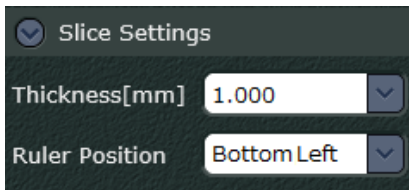

Use the pull-down menu for “Thickness [mm]” to set the thickness. Greater thickness reduces artifacts and noise. Thinner slices will yield greater sharpness. When the thickness is changed the CT slices are re-sliced. Below “Thickness [mm]” is changed from “1.000 mm” to “4.000 mm”.

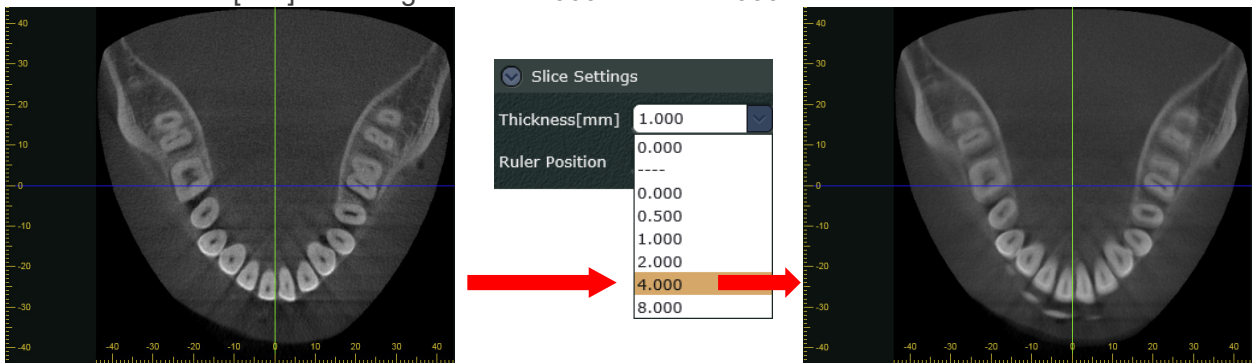

Use the pull-down menu for “Ruler Position” to set the ruler for the slice images.

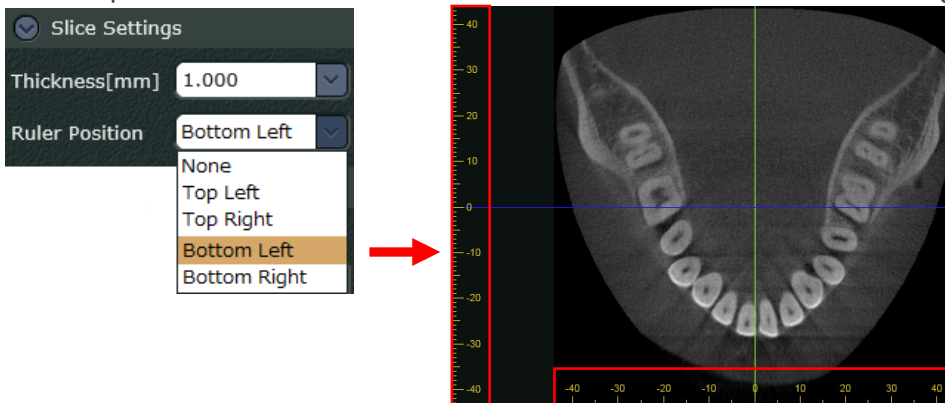

12.3.3. Filter Settings

The “Slice” section below is for CT slices as well as panoramic images and cross section images made according to the methods on “Make panoramic and cross section images” (p. 128) and “Make a pair of panoramic and cross section images” (p. 143) and is used to adjust image quality. The “Volume Rendering” section below is for adjusting volume rendered image quality.

Filter Settings

Slice

Filter Type Median

Median Radius 1

Binning 1

Volume Rendering

Filter Type Mean

Median Radius 1

Binning 2

Apply and Reload volume

Setting categories are “Filter Type”, “Median Radius”, and “Binning”.

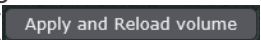
After making a setting, click the Apply and Reload volume button () to display the adjusted image.

“Filter Type”

Select a filter to adjust image quality.

There are two filters: Median and Mean.

- * The mean filter averages out the value of neighboring voxels and produces a smoother image.
- * The median filter compares the values of neighboring voxels and adjusts the middle order value from the low order value. This changes the value of a voxel that stands out for the others and is effective in eliminating fine noise.

“Median Radius”

This can only be used if the “Filter Type” is set for “Median”.

“Median Radius” determines the number of voxels compared by the median filter.

The greater the value, the greater the number of voxels compared so that fine noise is more effectively eliminated.

“Binning”

This is enabled when the voxel size is changed.

Neighboring voxels are combined and processed.

The greater the value, the greater the number of voxels combined and the larger the voxel size becomes.

CAUTION

- **Large settings for “Median Radius” and “Binning” can require more processing time and result in a blurry image.**

12.3.4. Other Settings

This sets the position and color for the orientation indicator for both CT slice and volume rendered images.

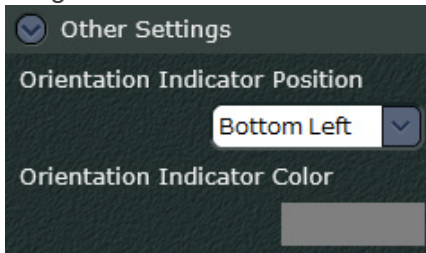

Use the pull-down menu for "Orientation Indicator Position" to select the position for the orientation indicator.

Click the "Orientation Indicator Color" box and then select a color for the orientation indicator.

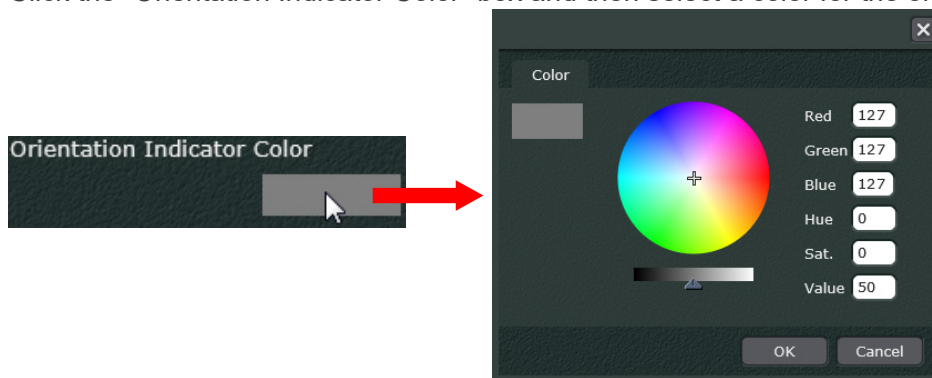

In the image below, the indicator is set for "Bottom Left" and the color is set for ().

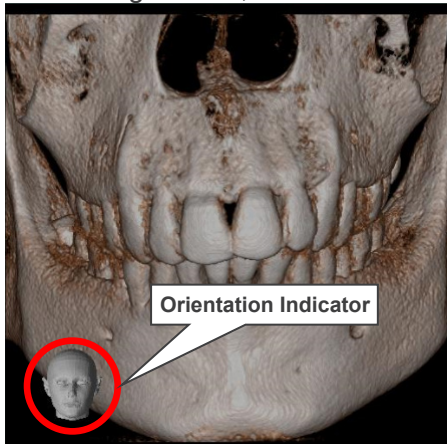

12.3.5. CurvedMPR Settings

When the screen for generating panoramic and cross-sectional images is displayed, click the button () that switches to the control panel settings panel to display the following settings items. You can configure settings related to axial images (Z-slice image), panoramic images, and cross-sectional images.

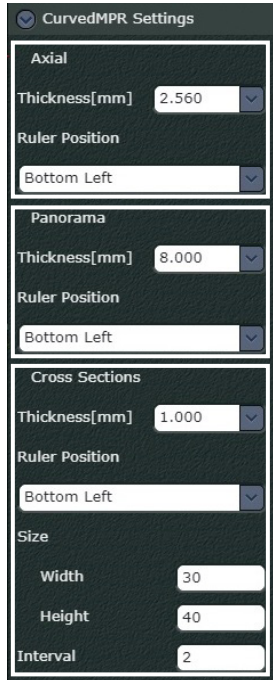

Settings for axial images (Z-slice image)

Settings for panoramic image

Settings for cross-sectional image

“Thickness[mm]”

You can set the thicknesses of the axial image, panoramic image, and cross-sectional images. A lower thickness enables clearer display of edges and contrast differences. A higher thickness reduces artifacts and noise.

Example: Change the thickness of the panoramic images from 1.000 mm to 4.000 mm.

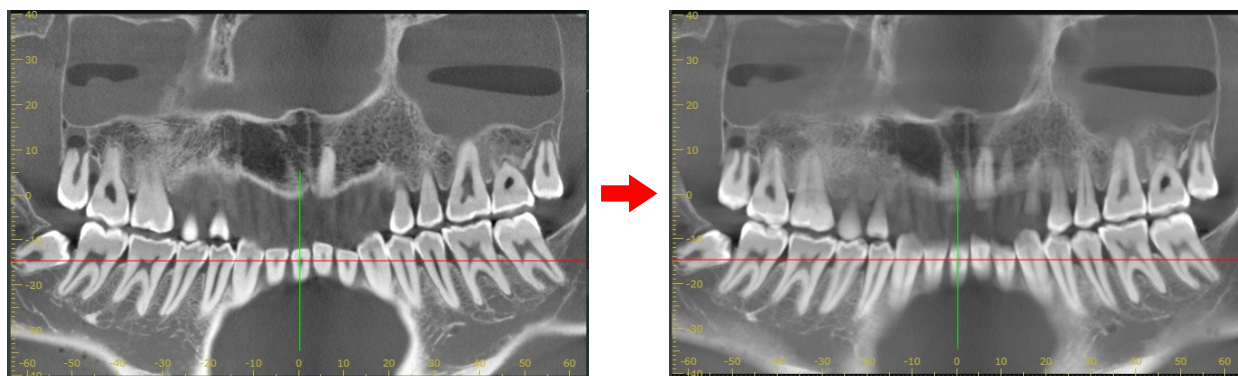
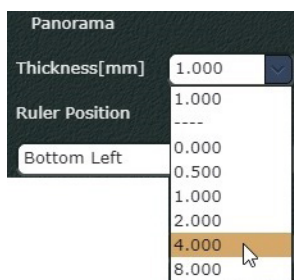

“Ruler Position”

You can set the display position of the ruler for the axial image, panoramic image, and cross-sectional images.

Example: Set the display position of the ruler in the cross-sectional images from the lower left side to the upper left side.

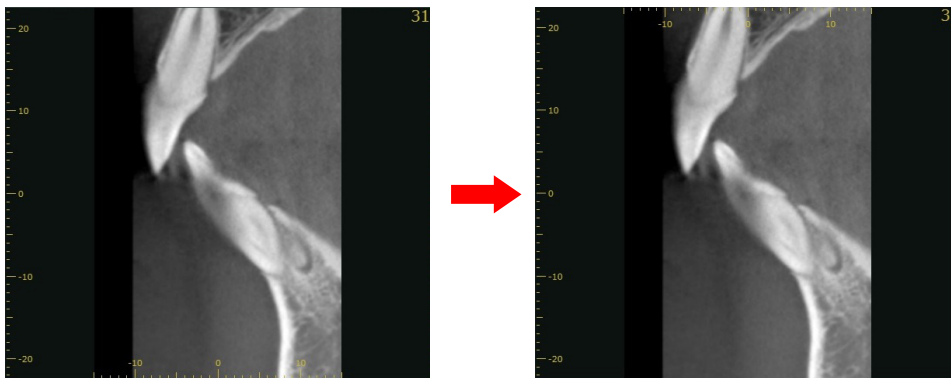

“Size”

You can set the width and the height of the cross-sectional image.

Example: We will change the width from 30mm to 45mm and the height from 45mm to 60mm. Note the effect below.

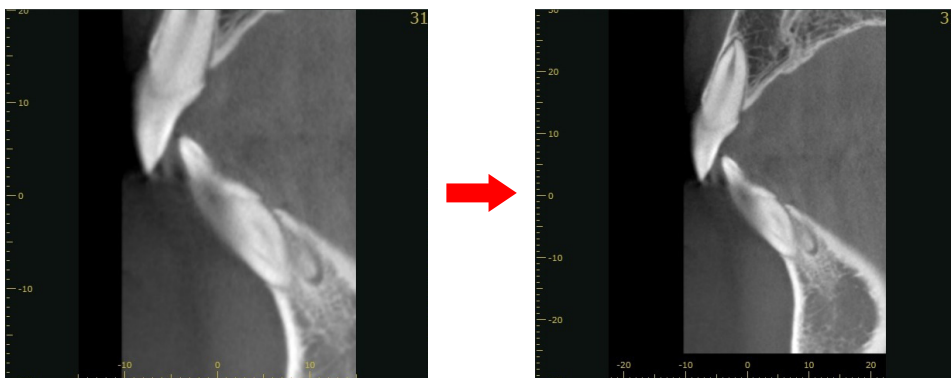

“Interval”

You can set the interval at which cross-sectional images are generated. The longer the interval, the fewer cross-sectional images are generated. You can confirm the position of the cross-sectional image by using the orthogonal lines displayed in the axial image.

Example: Change the interval from 2 mm to 4 mm.

Cross Sections	
Thickness[mm]	1.000
Ruler Position	Bottom Left
Size	
Width	15
Height	45
Interval	4

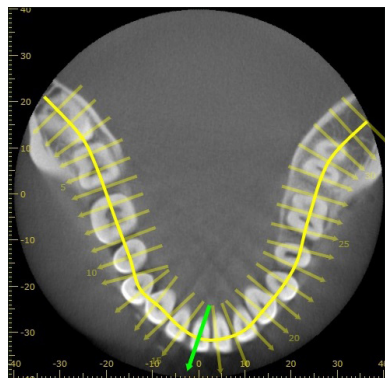
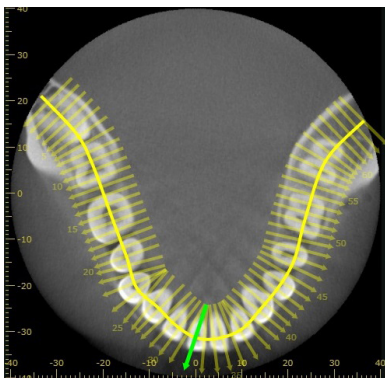

12.3.6. Dual CMPR Settings

When the screen for generating a second set of panoramic and cross-sectional images is displayed, click the button () that switches to the control panel settings panel to display the following settings items.

You can configure settings related to axial images (Z-slice images), panoramic images, and cross-sectional images.



The screenshot shows a control panel titled "Dual CMPR Settings" with five distinct sections, each with its own settings:

- Axial:** Thickness[mm] is set to 2.560. Ruler Position is set to Bottom Left.
- DualCMPR1 Panorama:** Thickness[mm] is set to 8.000. Ruler Position is set to Bottom Left.
- DualCMPR1 Cross Sections:** Thickness[mm] is set to 1.000. Ruler Position is set to Bottom Left. Size settings are Width: 30, Height: 40, and Interval: 2.
- DualCMPR2 Panorama:** Thickness[mm] is set to 8.000. Ruler Position is set to Bottom Left.
- DualCMPR2 Cross Sections:** Thickness[mm] is set to 1.000. Ruler Position is set to Bottom Left. Size settings are Width: 30, Height: 40, and Interval: 2.

Labels to the right of the screenshot identify each section:

- Settings for axial images (Z-slice images)
- Settings for the first panoramic images
- Settings for the first set of cross-sectional images
- Settings for the second set of panoramic image
- Settings for the second set of cross-sectional images

"Thickness[mm]"

You can set the thicknesses for the axial image, as well as for the first and the second sets of panoramic and cross-sectional images.

"Ruler Position"

You can set the display position of the ruler for the axial image, and for the first and the second sets of panoramic and cross-sectional images.

"Size"

You can set the width and the height of the first and the second sets of cross-sectional images.

"Interval"

You can set the interval at which the first and the second sets of cross-sectional images are generated.

* Setting examples are displayed in "12.3.5. CurvedMPR Settings" (p. 194).

12.3.7. Saving the Settings

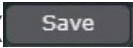
Click the “Save” button () under the “Save As Default Settings” section to save all settings configured in the settings panel to the i-Dixel WEB server.

Values stored on the i-Dixel WEB server are valid for all terminals.

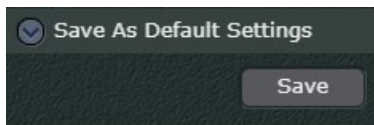

13. MWM Linkage

i-Dixel WEB can be supported by the following DICOM service classes and linked to HIS/RIS and PACS.

- DICOM Modality Worklist Management Service Class(MWM)
- DICOM Storage Service Class
- DICOM Modality Performed Procedure Step Service Class (MPPS)

With this linkage the following services can be used.

- The waiting list (worklist) for exposures can be obtained from the HIS/RIS system, and the next patient for exposure can be selected.
- An exposure can be transmitted to PACS.
- The HIS/RIS system can be notified after the exposure for a patient has been completed.

In this manual, MWM linkage refers to the time from Worklist acquisition until notification of exposure completion.

13.1. Acquisition of the Worklist

Acquire a worklist from HIS/RIS.

1. On the Home page, click the MWM button () on the tool bar to show the MWM display.

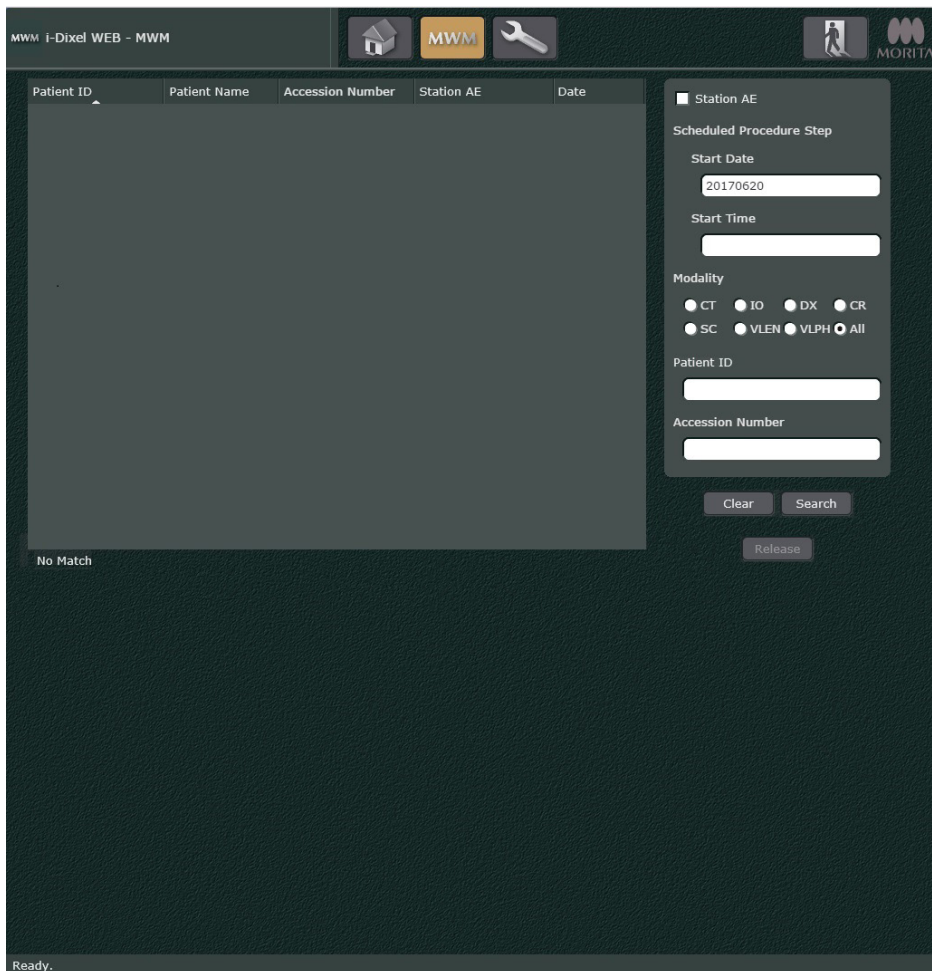

MWM i-Dixel WEB - MWM

Station AE

Scheduled Procedure Step

Start Date: 20170620

Start Time:

Modality

CT IO DX CR

SC VLEN VLPH All

Patient ID:

Accession Number:

Clear Search

Release

No Match

Ready.

- To obtain a worklist from HIS/RIS, click the Search button (**Search**). When the worklist is obtained, the worklist appears.

The screenshot shows the MWM interface with a search results table and a search filter panel. The table displays patient information for three patients: Morita Ichiro, Morita Jiro, and Morita Hanako. The search filter panel includes fields for Patient ID and Accession Number, and buttons for Clear, Search, and Release.

Patient ID	Patient Name	Accession Number	Station AE	Date
0000000001	Morita Ichiro	1	DICOMSRV01	20100906
0000000002	Morita Jiro	2	DICOMSRV01	20100906
0000000006	Morita Hanako	3	DICOMSRV01	20100906

- * If the worklist search conditions are entered and the Search button (**Search**) is clicked, the worklist can be narrowed.
- * The worklist search conditions are: start date (date images were taken), start time (time images were taken), modality (type of image/IOD type), patient ID, and accession number (reservation number).
The start date and start time can be searched by specifying a range.
E.g., Start Date: 20100101-20100930 (From January 1st, 2010 to September 30th, 2010)
Start Time: 090000-140000 (From 9:00:00 to 14:00:00 [2:00:00 p.m.])

The close-up shows the search filter panel with the following fields and options:

- Station AE
- Scheduled Procedure Step
- Start Date:
- Start Time:
- Modality:
 - CT IO DX CR
 - SC VLEN VLPH All
- Patient ID:
- Accession Number:

- * Click the Clear button (**Clear**) to erase the search conditions for the specified worklist.
- * The format of the patient names displayed in the search results follows the setting in the "Name sort order" dialog explained in "Title Bar:" (p. 6) of "2.2. Main Page" .

13.2. Taking Images

Select a patient on the worklist screen and take images of the patient.

1. Double-click to select the next patient for an exposure.

MWM I-Dixel WEB - MWM

Patient ID	Patient Name	Accession Number	Station AE	Date
000000001	Morita Ichiro	1	DICOMSRV01	20100906
000000002	Morita Jiro	2	DICOMSRV01	20100906
000000006	Morita Hanako	3	DICOMSRV01	20100906

Station AE
Scheduled Procedure Step
Start Date

Patient ID	Patient Name	Accession Number	Station AE	Date
000000001	Morita Ichiro	1	DICOMSRV01	20100906
000000002	Morita Jiro	2	DICOMSRV01	20100906
000000006	Morita Hanako	3	DICOMSRV01	20100906

Patient ID
Accession Number
Clear Search
Release

9/6/2010 1:08:56 PM 3matched

Ready.

The Main page for the selected patient will automatically appear.

Morita, Ichiro 000000001

Search Morita, Ichiro 000000001

Modalities

- CT
- IntraOral
- Panorama
- Camera
- XII-Movie
- XII-Still
- Video
- Cephalo
- OtherImage
- CT-Scout
- PanoramaPlus
- All

Image created

Start

End

Study date



Start Search

End

Images

No images found.

Ready.

- * If the patient selected by double-clicking is not in the i-Dixel database, the patient will automatically be registered in the data base and the Main page will appear.
- * To change the patient, click the Release button () on the MWM order list page.
- * If the main page is displayed, click the Home button () on the main tool bar and go back to the home page, and then click the MWM button () to retrieve the order list.

2. Take the patient's images.
The images taken are saved in the i-Dixel database.

13.3. Transfer of an Image to a PACS

Transfer an image to a PACS.

1. Display the image for transfer to PACS in the 2D viewer.

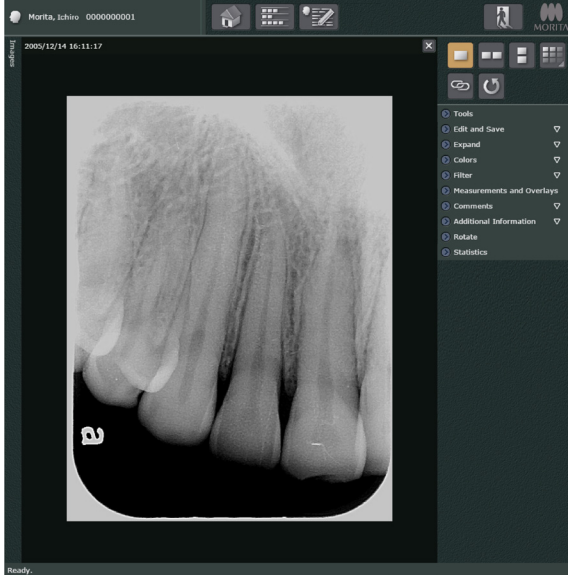

2. Click the Tools button () and select “Transfer to PACS”.

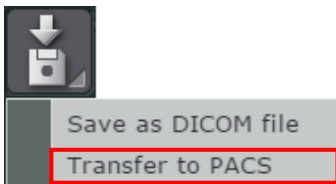

To transfer CT slice images, click “Transfer to PACS” then click a desired image type in the submenu.

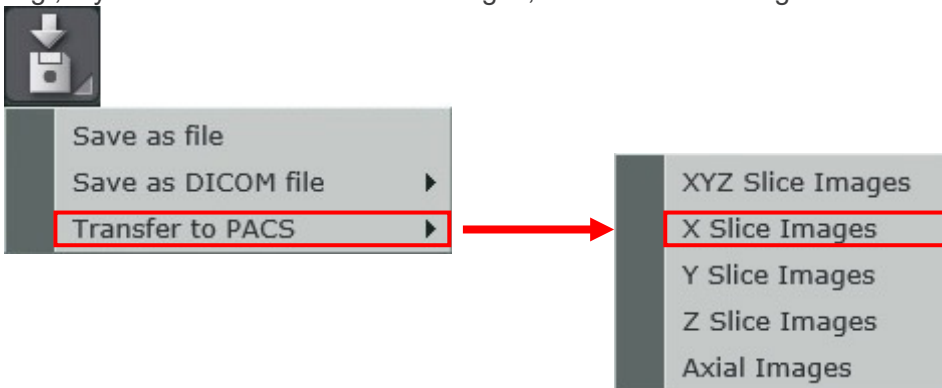

E.g., If you want to transfer X slice images, select “X Slice Images” in the submenu.



- * When transferring an image to a PACS, the IOD type, patient orientation, part and accession number (reservation number) may be required.
- * Select “PACS DICOM file Axial Image” to transfer the axial images a PACS according to the section “Transport CT Slice Images in DICOM Format” (p. 111).

13.4. Notification that Image-exposure has been completed

Notify HIS/RIS that image-taking has completed.

1. After sending an image to PACS, click the Home button () on the main tool bar to go back to the Home page.
Click the MWM button () to go to the MWM display.

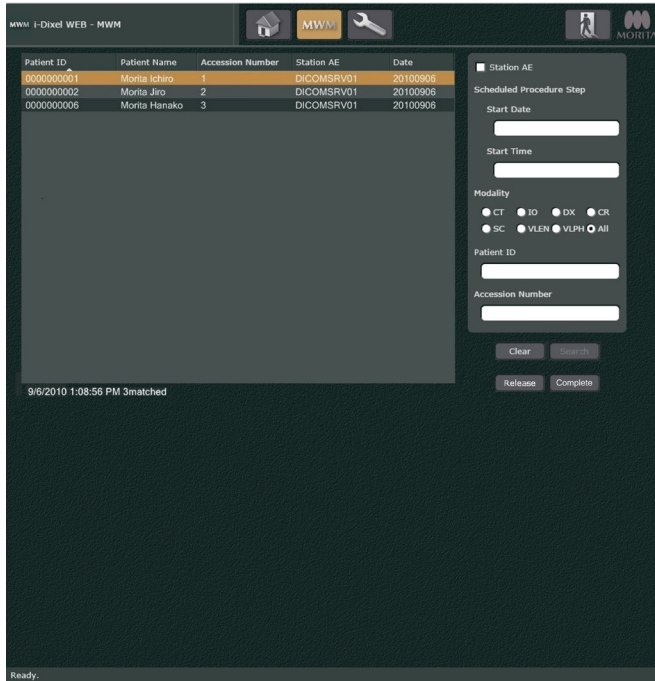

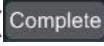
2. Click the Complete button () to notify HIS/RIS that image taking is complete.



* Before notifying the HIS/RIS system of exposure completion, you may change the selected patient by clicking the Release button ().

14. Image Export and PACS Transfer with LinkTo

LinkTo allows you to export images in DICOM format and launch applications to view and edit the exported images.

You can also forward DICOM images to PACS using LinkTo.

DICOM images that can be exported or transferred to PACS with LinkTo are the 2D images and CT slice images (X, Y, Z slice images, Axial images).

In order to utilize the LinkTo feature, it is necessary to enable displaying the LinkTo button on the navigation bar by following “15.3.2. LinkTo Settings” (p. 212).

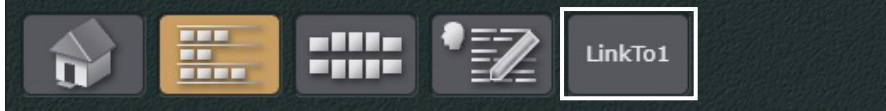

The LinkTo feature is explained below using example cases.

Example 1: Exporting a 2D image and launching an application.

1. Select a 2D image on the image list screen or display the 2D image in the 2D Viewer.
2. Click the LinkTo button on the navigation bar.
The actions taken when clicking the LinkTo button depend on the settings for that button and include the optional export folder path and application to launch.

Example 2: PACS transfer of the X, Y, Z slice images.

1. Select the CT slice image from the image list screen, or display the CT slice image in the 2D Viewer or 3D Viewer.
 2. Click the LinkTo button on the navigation bar.
The actions taken when clicking the LinkTo button depend on the settings for that button and include the optional export folder path and application to launch.
- * If you click the LinkTo button, you may be required to specify the PACS to which the image will be transferred, set the Accession Number, set the IOD type, set the patient direction when taking an image, and set the dentition/region.

15. Settings

You may use the below dialogue to change background color etc.

Click the Settings button () on the Home page.
The below dialogue will appear.
Click a tab to change the setting items.

* For details see “2.1. Home Page” (p. 2).

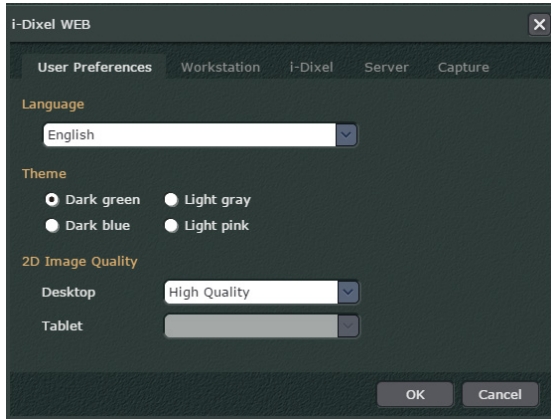

15.1. User Preferences

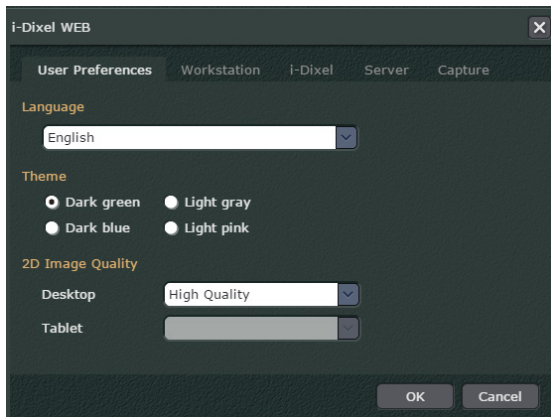

“Language”

Select the language for the i-Dixel WEB. After the setting is made, i-Dixel WEB will be re-loaded to enable it. Separate settings can be made for different users (IDs).

However, the first time i-Dixel WEB is used (before a language preference settings has been made) the display language will be according to the web browser language preference setting.

- **Microsoft Edge**

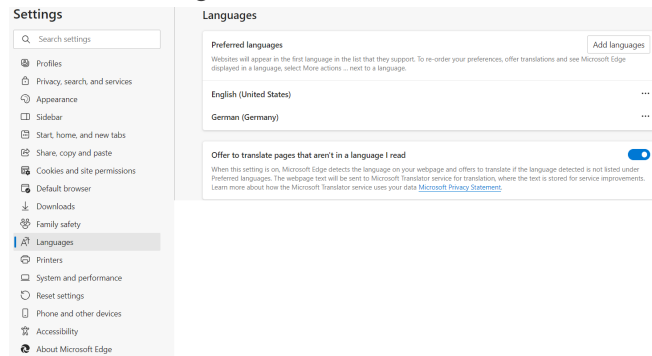

- **Safari**

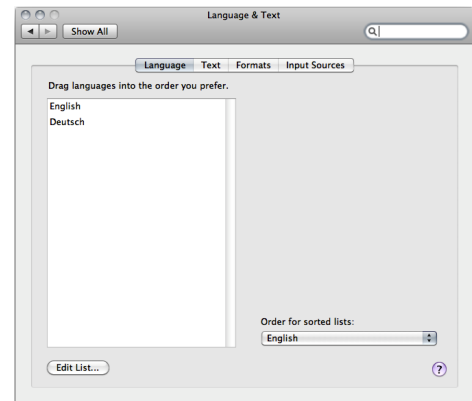

“Theme”

Select the background color.

“2D Image Quality”

Set image quality for the 2D viewer.
There are 2 image quality settings:

“High Quality”

2D viewer display uses less image compression.
Better image quality than “High Performance”

“High Performance”

2D viewer display uses more image compression.
Display speed is faster than “High Quality”

Use “Desktop” to set the image quality for computers other than tablet terminals.
Use “Tablet” to set the image quality for tablet terminals.

15.2. Workstation

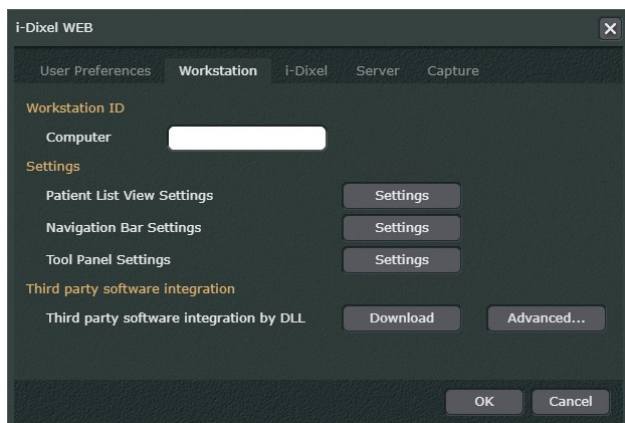

15.2.1. PatientList View Settings

Click the “Settings” button under "PatinetList View Settings" to display the following dialog. You can set items to be displayed or hidden in the patient list.

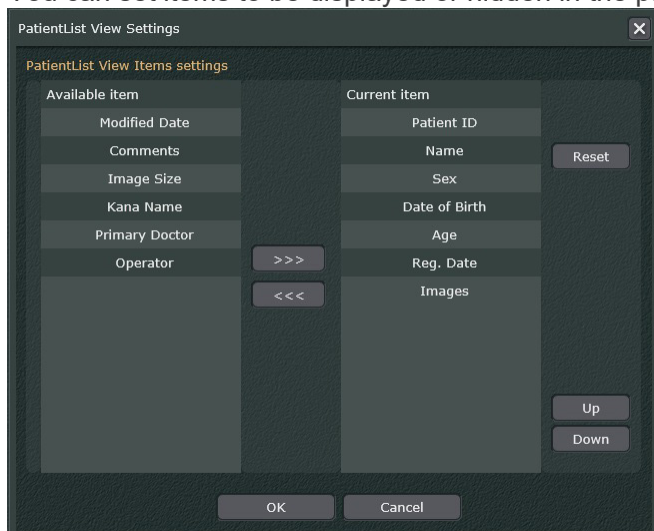

For visible items in the patient list, select a desired item in the “Available item” list and click the Move to Right button (**>>>**).

To delete items from the patient list, select a desired item in the “Current item” and click the Move to Left button (**<<<**).

The order in which items are displayed in the patient list are the same as the order in the “Current item” list. You can change the order by selecting an item in the “Current item” list and clicking the Up or Down button.

Items in the “Current item” list are displayed in the shortcut menu as described in **“Change Display Parameters”** (p. 31).

To restore the default settings, click the Reset button.

* The set values are only valid for the terminal on which the settings were modified.

15.2.2. Navigation Bar Settings

Click the “Settings” button under “Navigation Bar Settings” to display the following dialog. You can set the buttons to be displayed in the navigation bar.

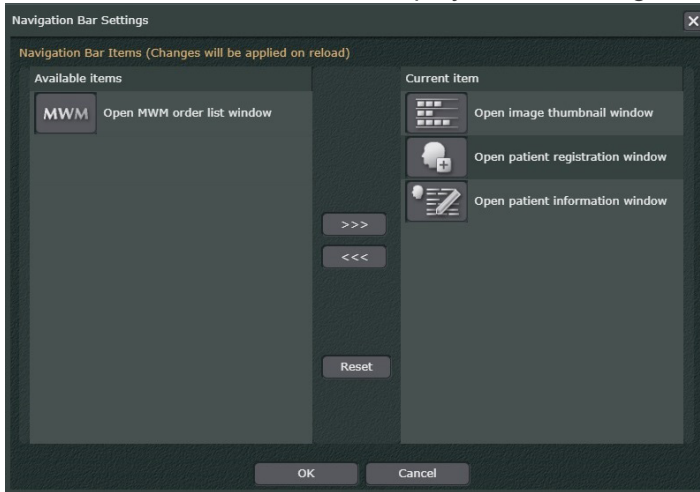



Buttons listed in the “Available Items” list are the buttons that are not displayed in the navigation bar. Buttons listed in the “Current Items” list are buttons that are displayed in the navigation bar.

To display a button, select the it from the “Available Items” list and click on the button () to move the selected button to the “Current Items” list.

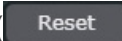
To hide a button, select it from the “Current Items” list and click on the button () to move the selected button to the “Available Items” list.

Click the “Reset” button () to return to the default settings.

- * The order in which the buttons are displayed cannot be changed.
- * It is not possible to modify display settings for the LinkTo button, the home screen button (), or the settings button ().
- * The set values are only valid for the terminal on which the settings were modified.

15.2.3. Tool Panel Settings

Click the “Settings” button under “Tool Panel Settings” to display the following dialog. You can set the items to be displayed in the tool panel of the 2D viewer.

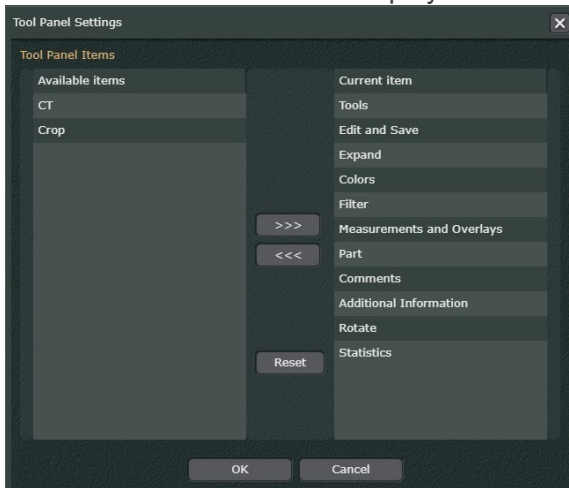

Items listed in the “Available Items” list are items that are not displayed in the 2D viewer.
Items listed in the “Current Items” list are items that are displayed in the 2D viewer.

To display an item, select it from the “Available Items” list and click on the button () to move the selected item to the “Current Items” list.

To hide an item, select it from the “Current Items” list and click on the button () to move the selected item to the “Available Items” list.

Click the “Reset” button () to return to the default settings.

- * The order in which the items are displayed cannot be changed.
- * The set values are only valid for the terminal on which the settings were modified.

15.3. i-Dixel

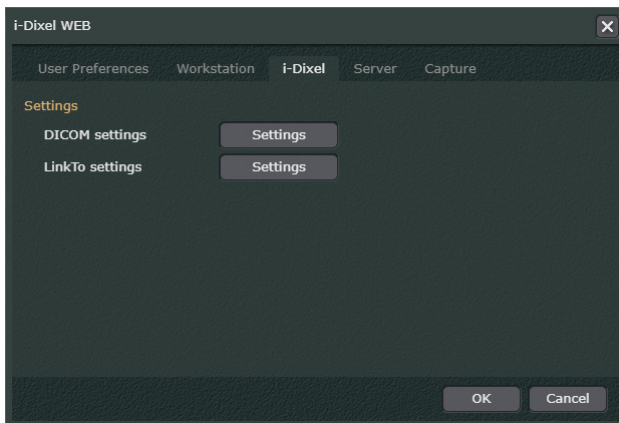

15.3.1. DICOM Settings

Click the “DICOM settings” button () to display the following dialog. This is the setting page for connecting to HIS/RIS, PACS and DICOM. If i-Dixel is connected to DICOM, the setting items will be displayed.

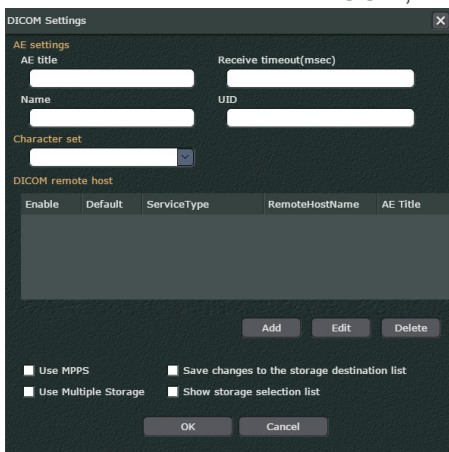

The “AE settings”, “Character set” on the upper part of the page are used to set the AE title, character set etc. for the i-Dixel WEB or i-Dixel.

Click the Add button () to display the page shown below and then make the setting for the AE title of the HIS/RIS, PACS etc.

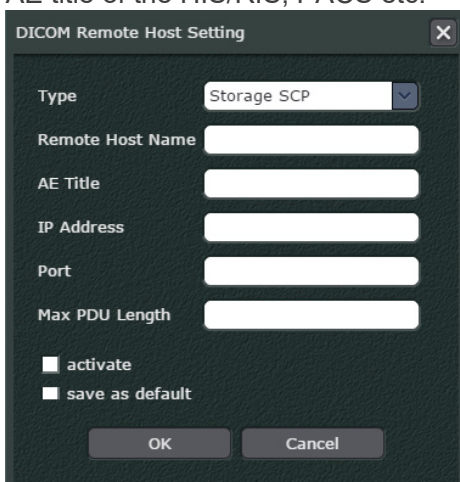

After the setting is made, it will be used for i-Dixel.

15.3.2. LinkTo Settings

Click the “LinkTo settings” button (**Settings**) to display the following dialog. You can add, modify, enable, disable, or delete LinkTo buttons.

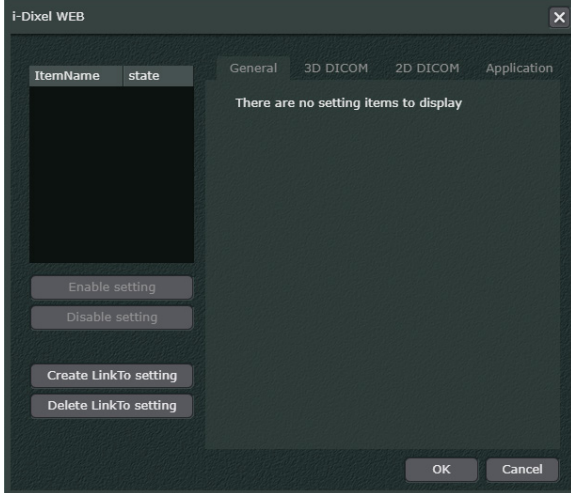

[Add Button]

1. Click the “Create LinkTo setting” button (**Create LinkTo setting**). The LinkTo button will be created and displayed in the list.

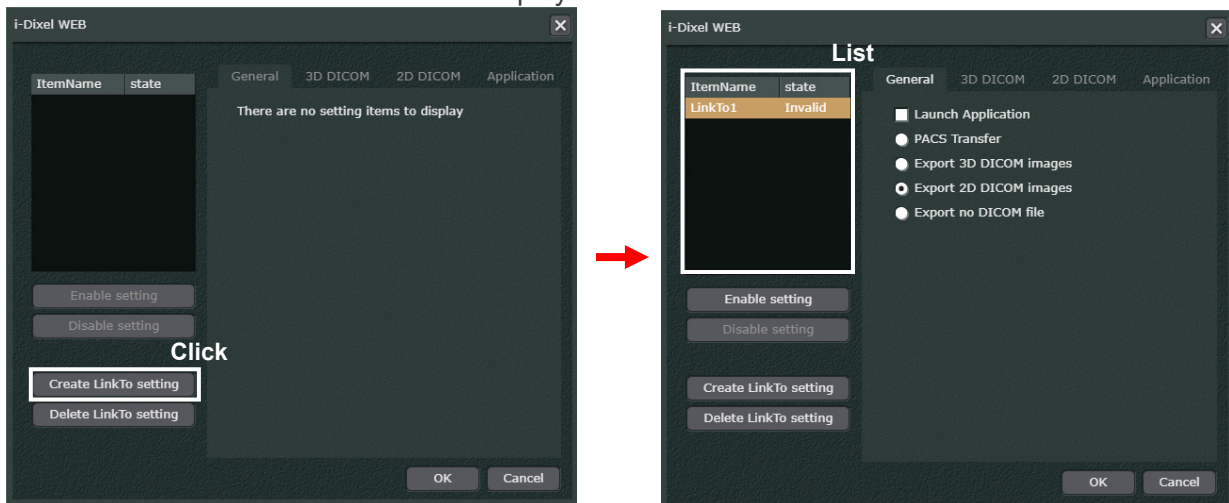

* You can add up to a maximum of 5 LinkTo buttons. The number of buttons includes buttons added by i-Dixel.

ItemName	state
LinkTo1	Enable
LinkTo2	Enable
LinkTo3	Enable
LinkTo4	Enable
LinkTo5	Enable

- Apply the following settings for the LinkTo button to be added.

“General”

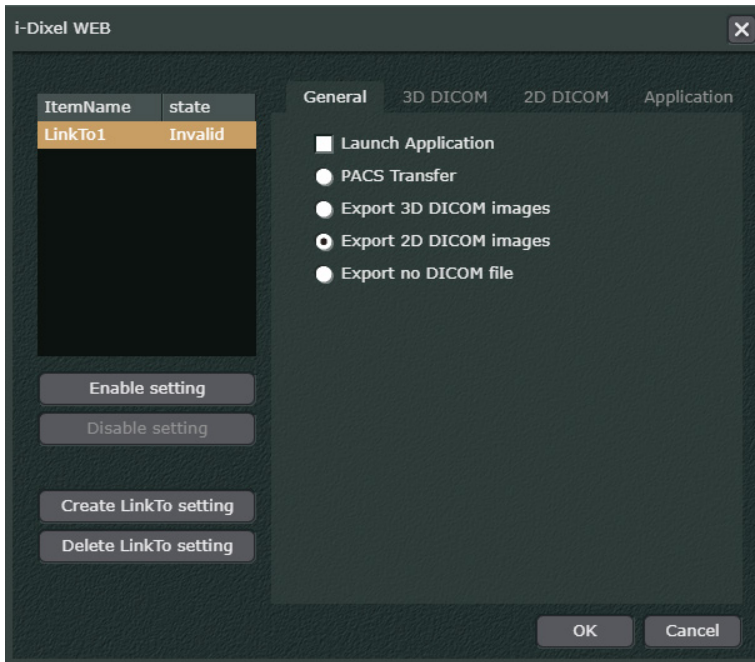

“Launch Application”

When selected, you can set an application to be launched. For more details see **“Application”** (p. 216).

- * If “PACS Transfer” is selected, then “Launch application” is grayed out. If “Export no DICOM file” is selected, then “Launch application” is grayed out with the checkbox selected. If “PACS Transfer” is selected, then axial and CT images can be transferred to a PACS, but the application used to automatically read the transferred images cannot be launched. If “Export no DICOM file” is selected, then the application is launched without exporting 2D or 3D data.

“PACS Transfer” Selected

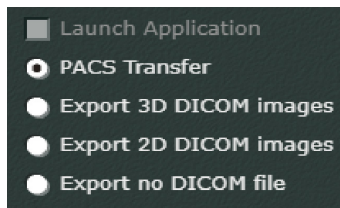

“Export no DICOM file” Selected



“PACS Transfer” or “Export 3D DICOM Images” or “Export 2D DICOM Images” or “Export no DICOM file”

To export CT slice or 2D images to PACS, select “PACS Transfer”.

To export CT slice images, select “Export 3D DICOM images”.

To export a 2D image, select “Export 2D DICOM images”.

- * Multiple selection is not supported.
- * If you want to start the application described in **“Application”** (p. 216) without exporting an image, select “Export no DICOM file”.

“3D DICOM”

The following settings are only enabled when transferring CT slice images to a PACS.

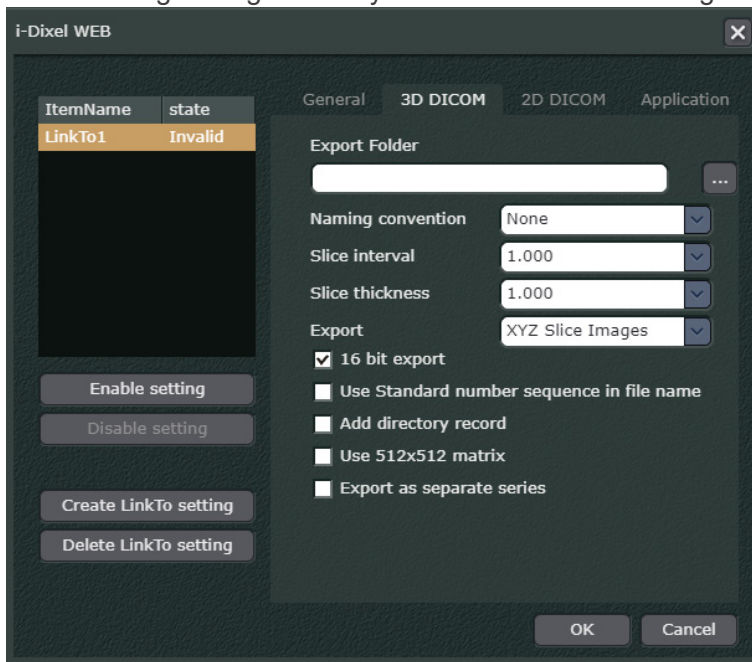

“Export Folder”

Set the path and folder name for the export destination.

- * When “PACS Transfer” or “Export no DICOM file” is set in “**General**” (p. 213), the setting becomes invalid.

“Naming convention”

You can set the naming conventions for the DICOM file name to be exported.

- None: A standard i-Dixel file name is assigned. The file name includes a “.dcm” file extension.
- DicomStandard: Files are named in accordance with DICOM rules, which restrict names to 37 types of characters (upper case alphanumeric characters or an underscore character). File names do not include a file extension.
- WithExtension: Files are named according to the same naming convention as “DicomStandard”. Unlike “DicomStandard” rules, the file names include a “.dcm” file extension.

- * Specify settings for converting names as specified for the device or software used to read the exported images.
- * To transfer images based on standard specifications specified by DICOM rules, select “DicomStandard” and select the “Add directory record” checkbox.

“Slice interval, Slice thickness”

Depending of the settings for slice interval and slice thickness, the CT volume data can be re-sliced and the resulting CT slice image exported.

- * This is only possible if the “16 bit export” box is checked.
- * This is only possible if the CT slice data is linked to the CT volume data.
- * The re-sliced CT slice data will not be saved in the i-Dixel database.

“Export”

Select either axial images or X, Y, or Z slice images as the images to export.

“16 bit export”

If this box is checked “Slice interval, Slice thickness” will be set according to “Use 512×512 matrix” and the CT slice image will be exported.

The pixel value for exporting CT slices is set for 16bit.

“Use standard number sequence in file name”

The file names for exported CT slices can be set for numerical order starting at 0. However, this is only if “Naming convention” is set for “None”.

“Add directory record”

Set this to make a DICOM directory record.

“Use 512×512 matrix”

This sets the size of the exported CT slice at 512×512 pixels. This is only possible if the box for “16 bit export” is checked.

“Export as separate series”

This allows specifying the method used to export X, Y, or Z slice images.

When selected, a series ID can be assigned to each X, Y, Z slice series individually when exported.

If not selected, each X, Y, Z slice series with share the same series ID.

However, the setting is only enabled if “XYZ Slice Images” is selected in “Export” field.

“2D DICOM”

The following settings are effective only when exporting a 2D image in DICOM format.

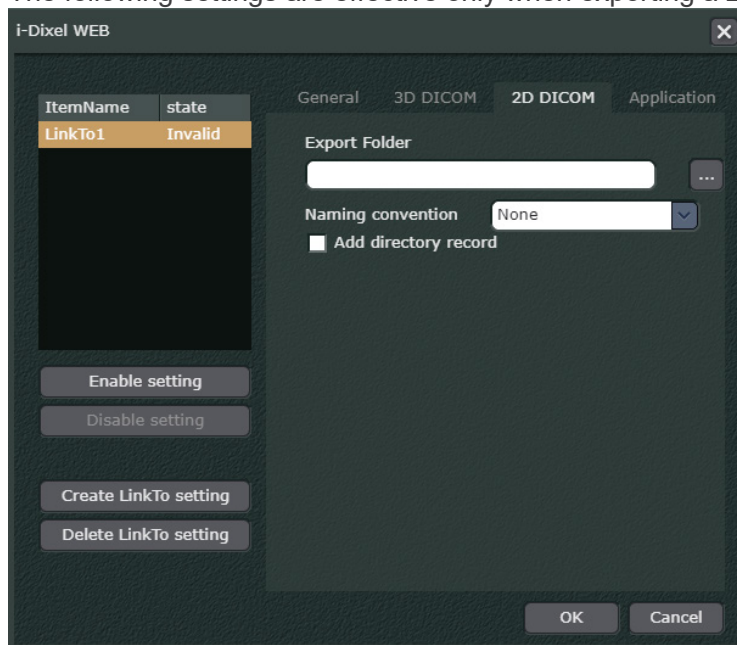

“Export Folder”

Set the path and folder name for the export destination.

* When “PACS Transfer” or “Export no DICOM file” is set in “**General**” (p. 213), the setting becomes invalid.

“Naming convention”

You can set the naming conventions for the DICOM file name to be exported.

None: A standard i-Dixel file name is assigned. The file name includes a “.dcm” file extension.

DicomStandard: Files are named in accordance with DICOM rules, which restrict names to 37 types of characters (upper case alphanumeric characters or an underscore character). File names do not include a file extension.

WithExtension: Files are named according to the same naming convention as “DicomStandard”. Unlike “DicomStandard” rules, the file names include a “.dcm” file extension.

* Specify settings for converting names as specified for the device or software used to read the exported images.

* To transfer images based on standard specifications specified by DICOM rules, select “DicomStandard” and select the “Add directory record” checkbox.

“Add directory record”

Set this to make a DICOM directory record.

“Application”

The following settings are valid when “Launch Application” is set in “General” (p. 213).

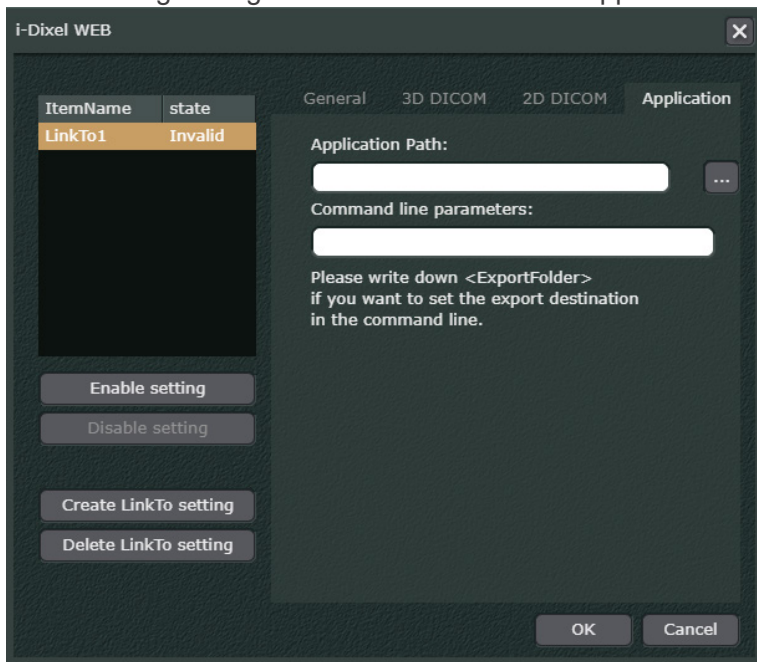

“Application path”

Set the start-up file name and start-up path for the application used to automatically download CT slices or a 2D image from the export destination.

“Command line parameters”

Set the command line parameters used when the application starts up. To include the export destination set in “Export Folder” in “3D DICOM” (p. 214) or “2D DICOM” (p. 215) as a command line argument, enter <ExportFolder> in the text box.

3. Make sure that “state” is switched to “Enable”.

ItemName	state
LinkTo1	Enable

- * If the setting in Step 2 is insufficient, the “state” becomes “Invalid”.
- * If the “state” is not set to “Enable”, the LinkTo button will not appear in the navigation bar.

4. Click “OK” to close the settings dialog.

[Change Button]

Select the LinkTo button from the list to change the settings.

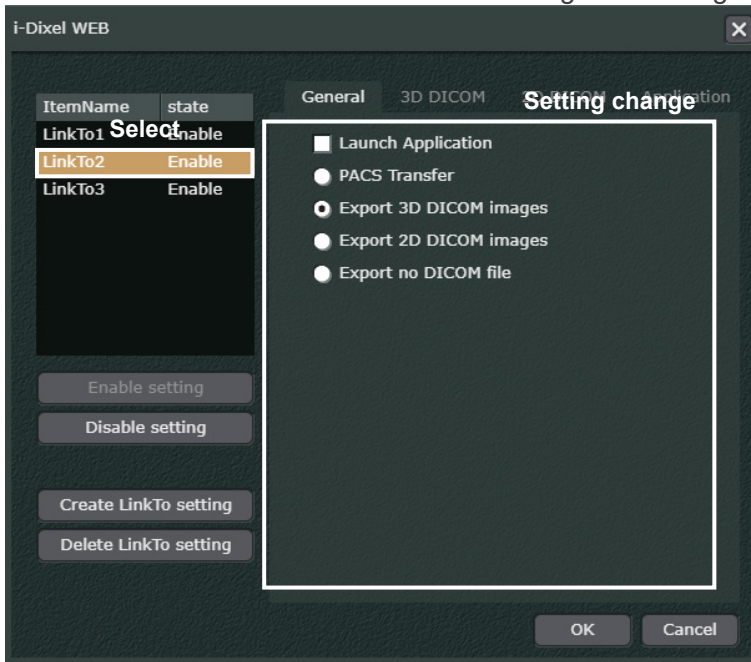

* If the changed settings are insufficient, the “State” becomes “Invalid”. When the settings are corrected, the “state” switches to “Enable”.

[Enable/Disable Button]

You can show or hide the LinkTo button displayed on the navigation bar.

Select the LinkTo button from the list.

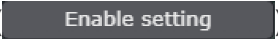
Click the “Enable setting” button () to switch the “state” to “Enable” and display the LinkTo button on the navigation bar.

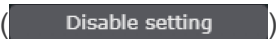
Click the “Disable setting” button () to switch the “state” to “Disable” and hide the LinkTo button on the navigation bar.



[Delete Button]

Select the LinkTo button you want to delete from the list and click the “Delete LinkTo setting” button (Delete LinkTo setting). You can delete no matter the button's current “state”. You can also delete buttons added by i-Dixel.

ItemName	state
LinkTo1	Enable
LinkTo2	Enable
LinkTo3	Enable

Enable setting

Disable setting

Create LinkTo setting

Delete LinkTo setting

ItemName	state
LinkTo1	Enable
LinkTo3	Enable

Enable setting

Disable setting

Create LinkTo setting

Delete LinkTo setting

15.4. Server

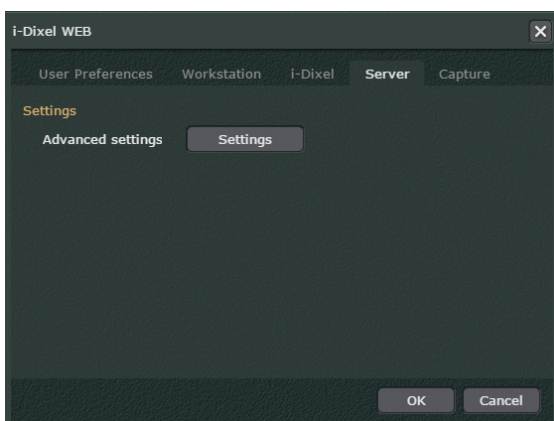

Click the Settings button () to display the dialogue box below.

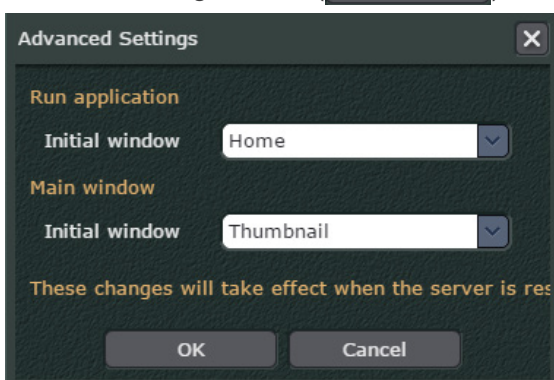

"Run application"

Set the initial window when i-Dixel WEB starts up.
Set it for the Home page or the MWM display.

"Main Window"

After selecting a patient, set the initial window display for the Main page.
If "Thumbnail" is selected, the image list will be displayed.

* "Thumbnail" is the only selection possible.

16. Error Messages

Error messages will appear if the connection to the i-Dixel WEB server is lost or if the connection is interrupted or unstable.

16.1. Connection Lost during Use

The connection to the i-Dixel server will be cut off, and the error messages shown below will appear for these reasons:

- Transmission failure for Wi-Fi connection
- The i-Dixel WEB has been executed beyond a day
- Computer has gone to sleep

Login timeout expired. Please refresh your browser.

Connection lost. Please refresh your browser.

Application Error occurred. Please refresh your browser.

If one of these error messages appears, see “Refresh Web Page” (p. III), refresh the web page and login again to re-establish the connection to the i-Dixel WEB server. For login details, see “3.1. Login” (p. 26).

16.2. Other i-Dixel WEB Server Connection Problems

The error message shown below will appear in the following cases:

- The i-Dixel WEB server has been turned off.
- The i-Dixel WEB application on the server is not working normally.
- The server connection has been lost due to a network problem such as a disconnected LAN cable or poorly operating wireless LAN device.
- The URL to access the i-Dixel WEB application is not rightly entered.

This page can't be displayed

- Make sure the web address <http://172.28.10.31> is correct.
- Look for the page with your search engine.
- Refresh the page in a few minutes.

[Fix connection problems](#)

If the above error message appears, check the following items to restore normal connections and operation.

1. Make sure the i-Dixel WEB server is running.
Start it up if it is not.
2. Make sure the i-Dixel WEB application is running.
If the web application on the server is not running, start it up.
3. Check all LAN cable connections.
Fix any faulty connections.
4. Check for defective LAN cables
Replace any defective cables.
5. Check LAN settings.
If the LAN settings on the computer you are using are not right, refer to the computer's user manual and make the correct settings.
6. Check the router
If the router for the LAN network is not working properly, refer to the user manual for the router and correct any operational problems.
7. Check wireless LAN settings
If the wireless LAN settings for the iPad and similar computers are not right, refer to the user manual for the computer and correct the settings.
8. Check the access point or wireless LAN router
If the access point or wireless LAN router is not working properly, refer to the device's user manual and set it up for normal operation.

If the network problems noted in items 3 to 8 above are corrected or did not exist in the first place, and the connection with the i-Dixel WEB server is still unavailable, re-start both the server and the i-Dixel WEB application on the server.

CAUTION

- ***Take great care in dealing with LAN or wireless LAN connection settings etc. Failing to properly correct settings for LAN or wireless LAN networks can lead to additional connection impediments. We recommend that you consult with the network administrator or Morita technical experts and take great care when correcting these types of problems or else have the network administrator or a Morita technical expert correct them for you.***

16.3. i-Dixel WEB Access Trouble

If you try to use the application using a web browser that does not support i-Dixel WEB access, or access using Safari's private browse mode, an error message will be displayed at the time of access.

Incompatible Browser

The message below will appear if i-Dixel WEB access is attempted with an incompatible browser.

This web browser or version is not supported by i-Dixel Web. Please try again with a supported browser.

Safari Private Browser Mode

If the Safari private browser mode is turned on, the error message shown below will appear when attempting to access i-Dixel WEB.

Please turn off private browsing mode. This web browser or version does not support WebStorage.

In this case turn off the Safari private browser mode to access i-Dixel WEB.

Accessing i-Dixel WEB using the InPrivate browse mode of Microsoft Edge is not supported. However, an error message will not appear.

Even if access is acquired, the i-Dixel WEB may not work properly.

Be sure to disable InPrivate browse mode of Microsoft Edge before accessing i-Dixel WEB.

In addition, use a web browser that meets the system requirements for Web browser to access i-Dixel WEB.

17. Cautionary Remarks

Cautionary remarks for using i-Dixel.

17.1. Cautionary remarks for distance measurements

There may be some difference between actual distances and measured distances due to computation, exposure principles etc. This is explained below.

17.1-(1) Computational errors for distance measurements

Distance measurements are made by clicking two pixels in the image.

The distance is calculated using the coordinates of the two pixels, the magnification ratio, and the pixel size (resolution). The formula used is shown below:

$$\text{Distance} = \text{Pixel Size} \times \frac{\sqrt{(X_2 - X_1)^2 + (Y_2 - Y_1)^2}}{\text{Magnification Ratio}}$$

- * X_1 and Y_1 are the coordinates for the first pixel clicked.
- X_2 and Y_2 are the coordinates for the second one.

The following is an example of the calculation and how an error occurs.

Calculation error 1

In the following calculation, the error is the pixel size is multiplied by $\sqrt{2}$ (approx. 1.41)

- Magnification Ratio: 1.0
- Pixel size (resolution): 0.1 mm
- Coordinates for first pixel clicked: $(X_1, Y_1) = (2, 2)$
- Coordinates for second pixel: $(X_2, Y_2) = (5, 5)$

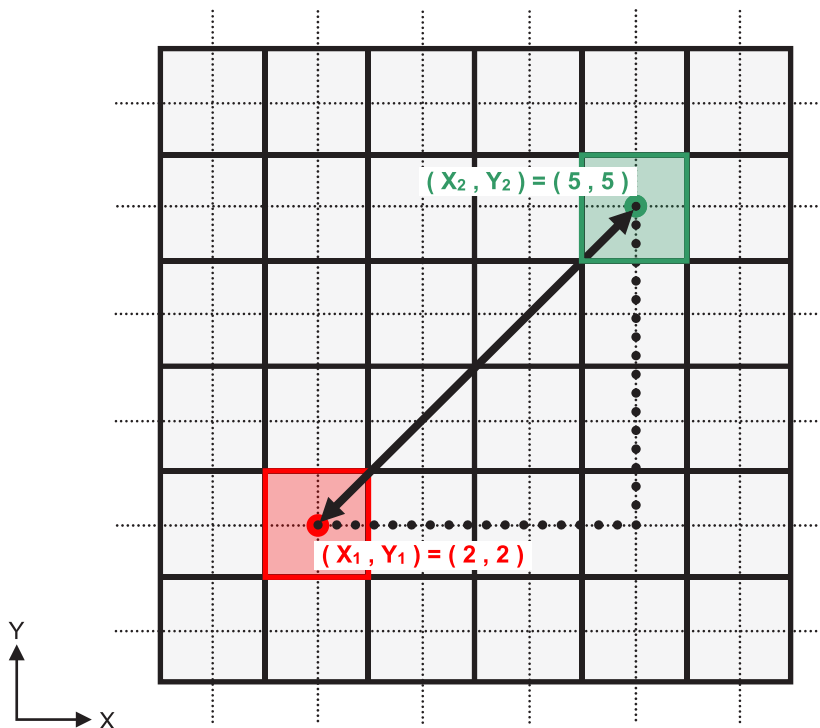

- * The dotted lines “.....” indicate the coordinate axis of the pixel’s position.
- The large heavy bordered squares (□) are pixels.
- The red frame indicates the first pixel clicked.
- The red dot indicates the coordinate position of the first pixel.
- The pixel with the green frame is the second pixel.
- The green dot indicates the coordinate position of the second pixel.

The length of the black line is calculated as follows:

$$\text{Length} = 0.1 \times \frac{\sqrt{(5 - 2)^2 + (5 - 2)^2}}{1.0} = 0.3 \sqrt{2} \doteq 0.42 \text{ (mm)}$$

Since the calculation depends on the coordinates of the pixels, the measurement error is shown below.

The calculated distance is show by the blue line in the diagram below and, compared to the true distance shown by the black line, it is longer by a factor of the pixel size times $\sqrt{2}$ (approx. 1.41) .

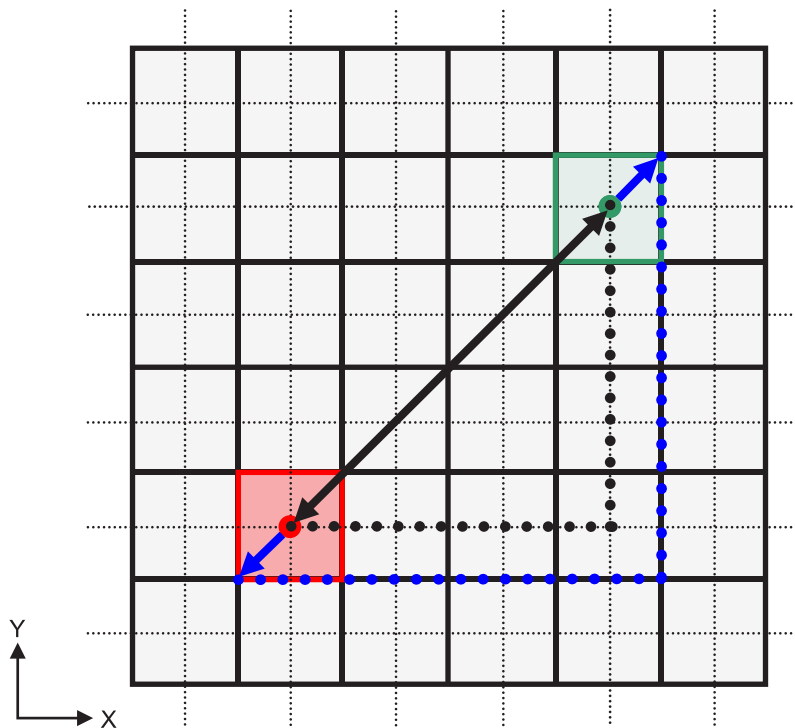

Calculation error 2

In the following calculation, the error is the size of one pixel.

- Magnification Ratio: 1.0
- Pixel size (resolution): 0.1 mm
- Coordinates for first pixel clicked: $(X_1, Y_1) = (2, 4)$
- Coordinates for second pixel: $(X_2, Y_2) = (5, 4)$

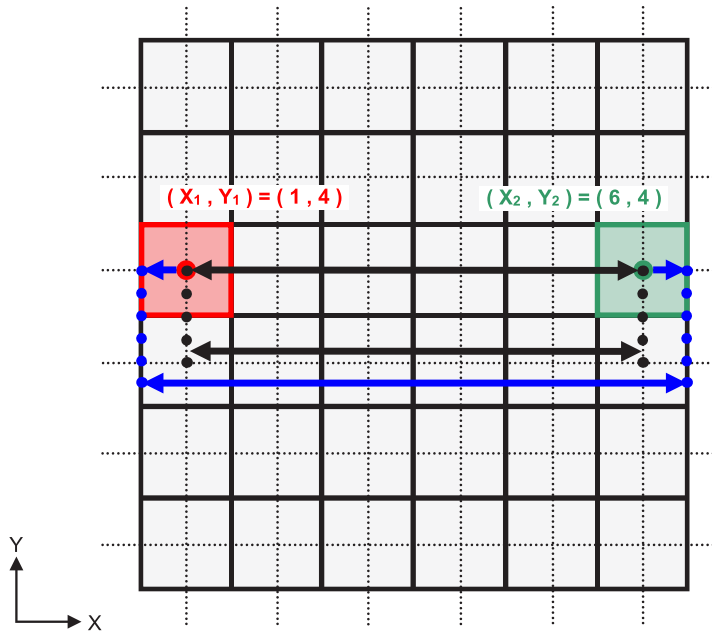

The length of the black line is calculated as follows:

$$\text{Length} = 0.1 \times \frac{\sqrt{(6 - 1)^2 + (4 - 4)^2}}{1.0} = 0.5 \text{ (mm)}$$

Since the calculation depends on the coordinates of the pixels, the measurement error is shown above. The calculated distance is shown by the blue line in the diagram above and, compared to the true distance shown by the black line, it is longer by one pixel.

17.1-(2) Measurement errors due to exposure principles

There is some distortion in images due to the principles of exposure technique. This distortion must be taken into consideration to make an accurate measurement.

Also, the magnification ratio may be other than specified if the patient is not properly positioned. In this case, an accurate measurement cannot be made.

Below are some examples of image distortion for intra oral X-rays, panorama X-rays and CT slice images.

(1) Intra oral X-ray

Maxillary incisor X-ray using the bifurcation method.

If the bifurcation line (the line that bifurcates the angle between the tooth axis and the image plate) is not 90 degrees to the X-ray beam, there will be some difference between the actual length and the exposure length.

The diagram below is for a maxillary incisor.

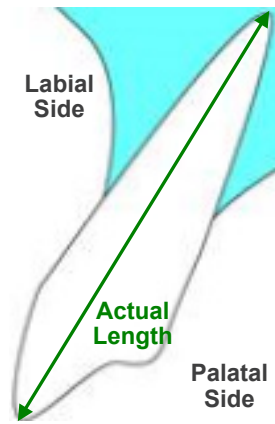

For 90 degrees

Exposure length equals actual length.

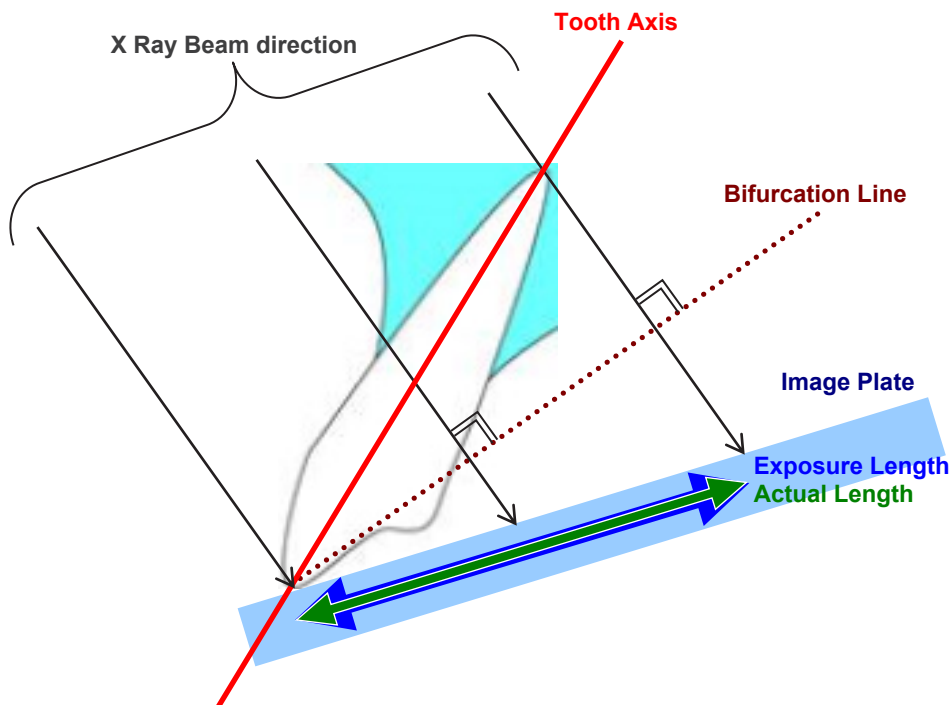

For less than 90 degrees

Exposure length is shorter than actual length.

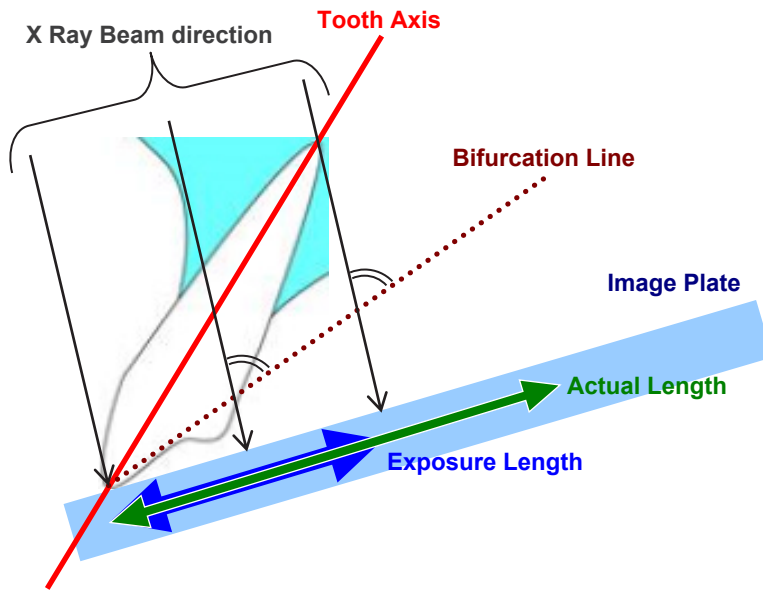

For more than 90 degrees

Exposure length is longer.

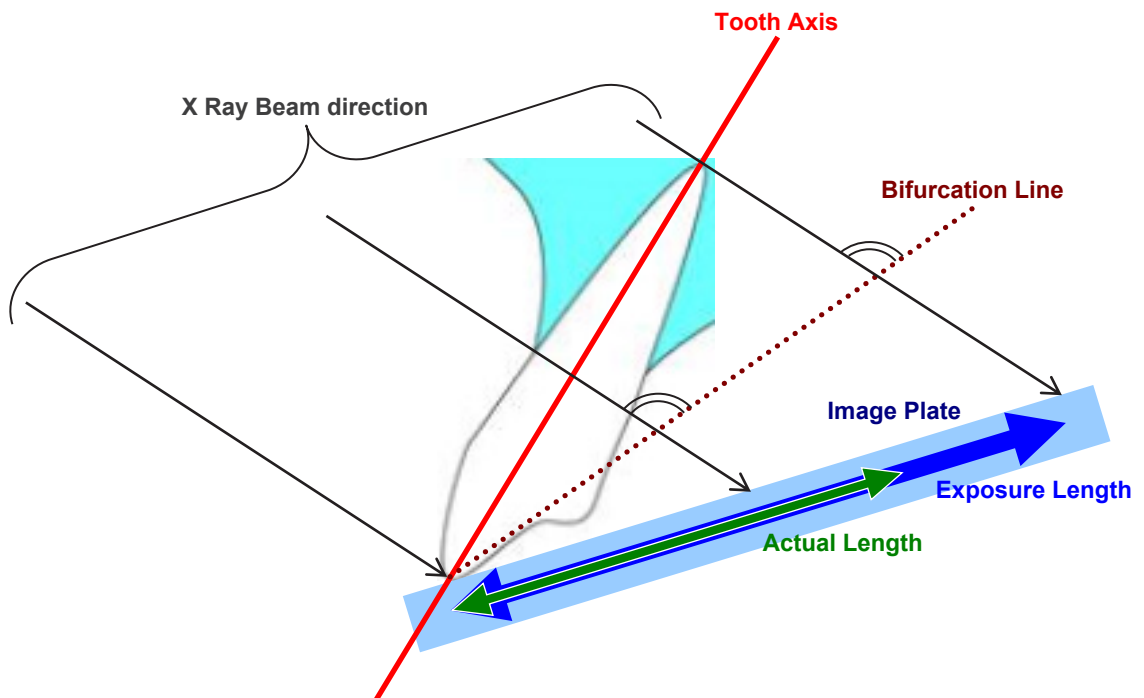

Maxillary molar X-ray using the bifurcation method.
Depending on the angle of the tooth axis, there will be some difference between the actual length and the exposure length.

The diagram below is for a maxillary molar.

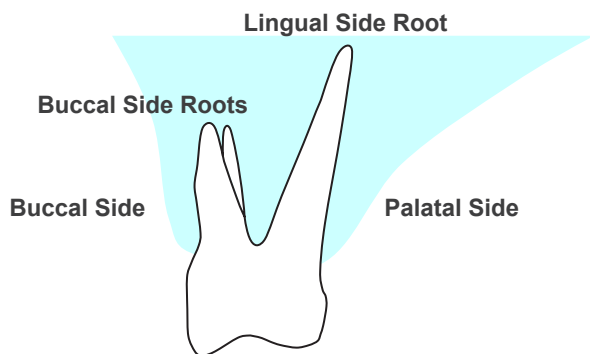

Positioned with the center of the molar as the tooth axis

The buccal side roots appear shorter and the lingual side root appears longer.

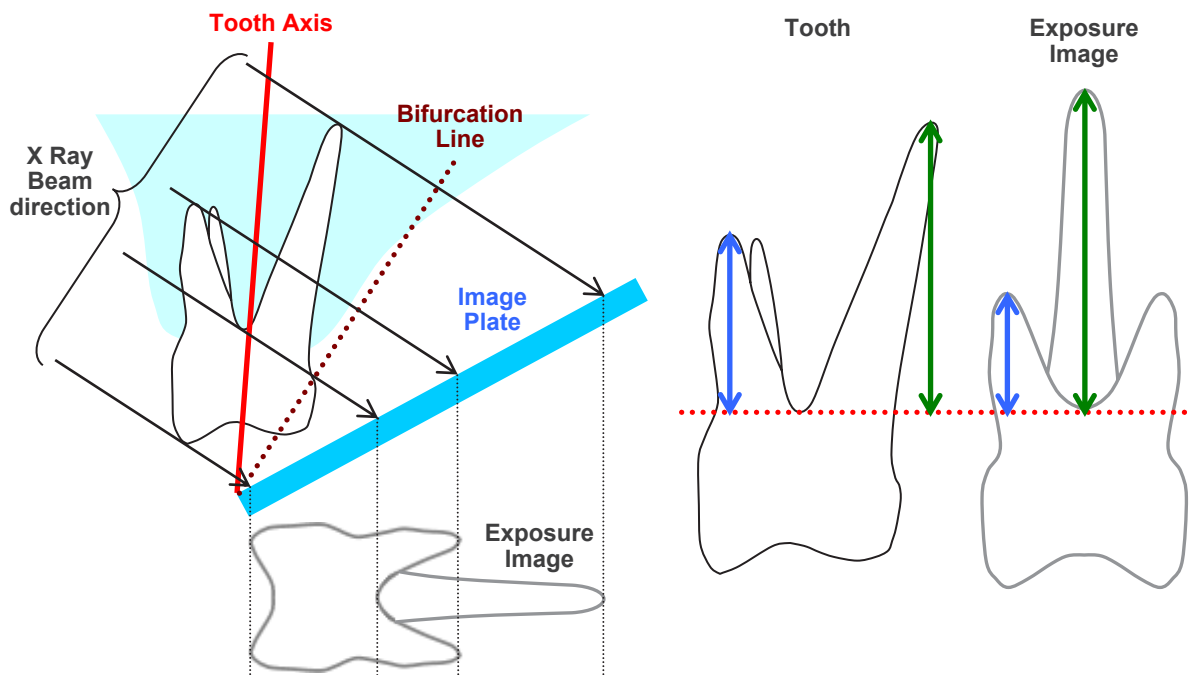

Positioned with the buccal side as the tooth axis

The lingual side root appears longer.

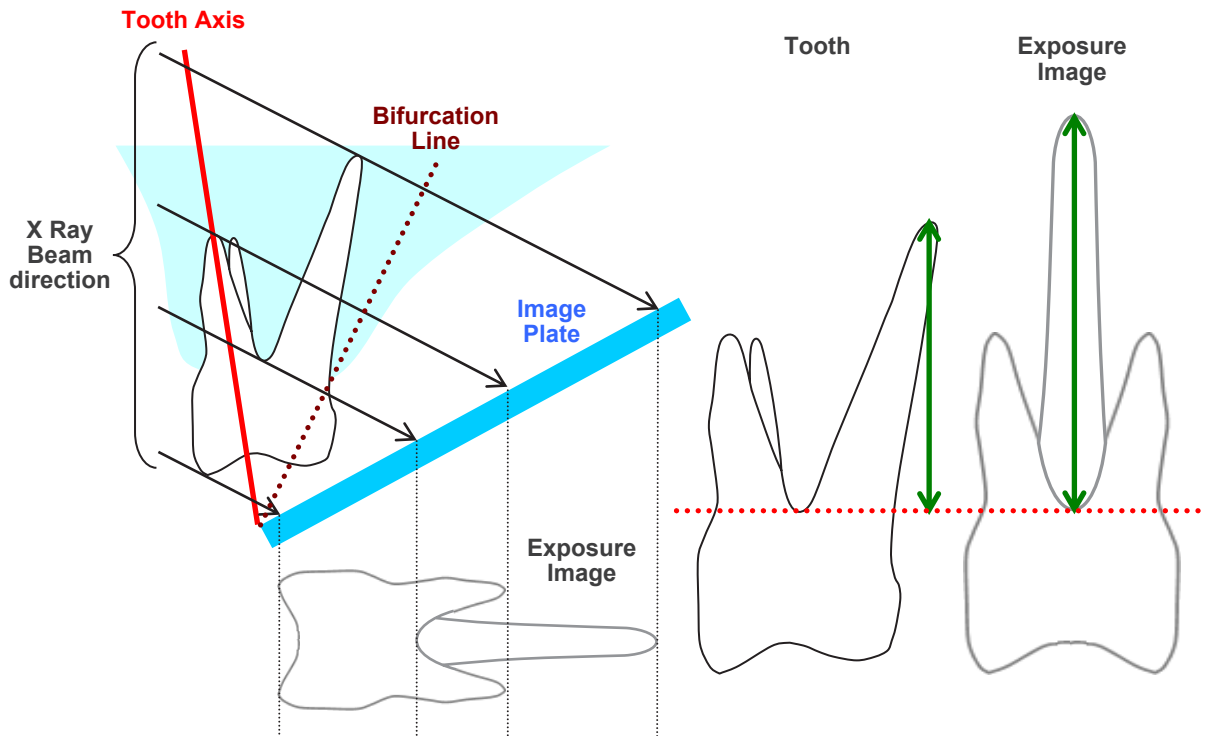

Positioned with the lingual side as the tooth axis

The buccal side roots appear longer.

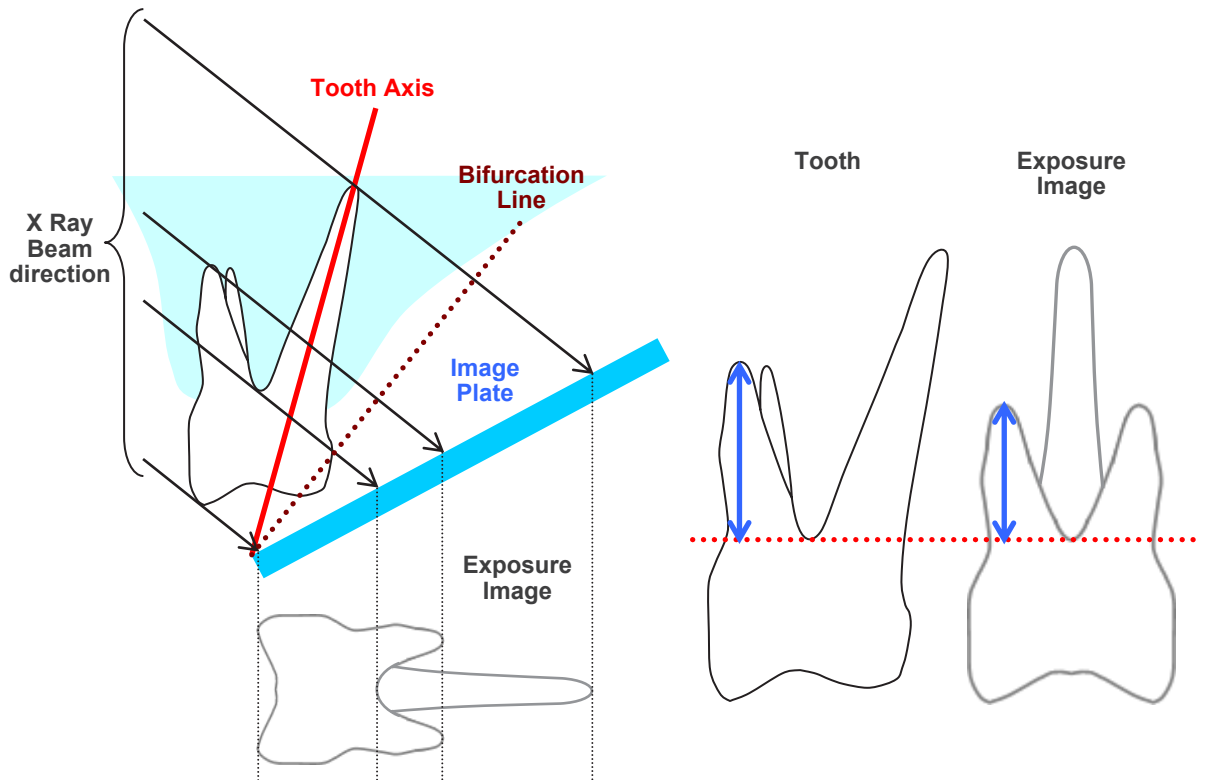

(2) Panorama X Ray Image

In the diagram below, the red region is the image layer and the gray region is the dental arch. In this case the magnification ratio will be as specified.

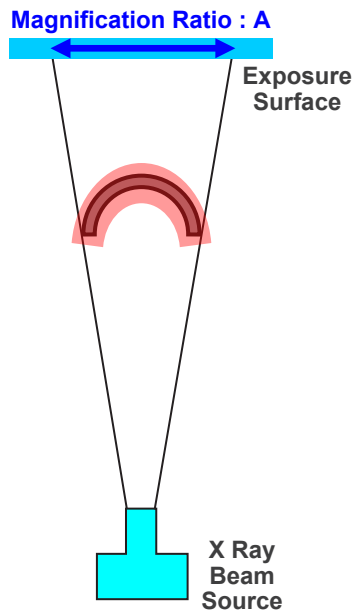

If the image layer is not positioned as shown in the diagram above, the magnification ratio of the image will be larger or smaller.

If dental arch is closer to the exposure surface

The magnification ratio will be smaller.

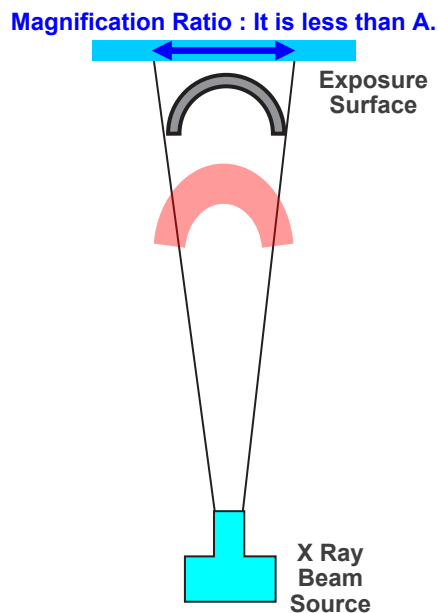
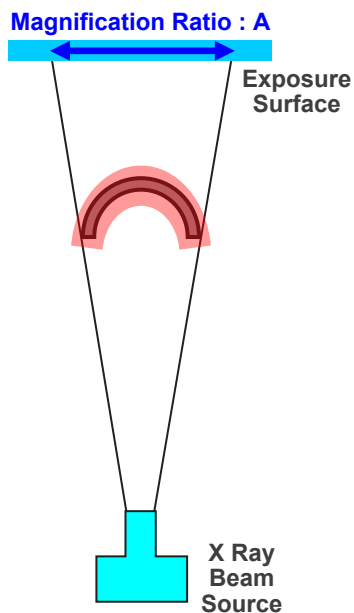

If dental arch is closer to the X-ray beam source

The magnification ratio will be larger.

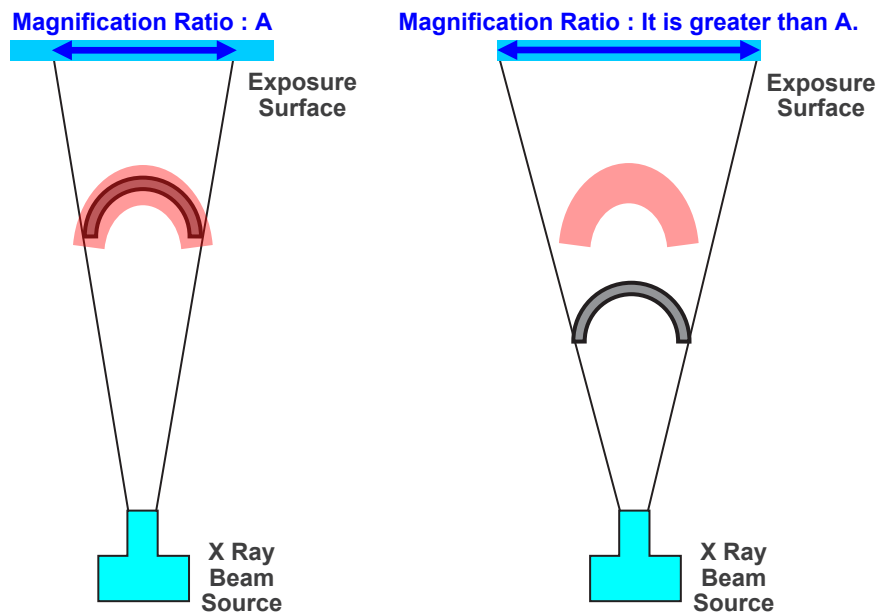

Also if the tooth axis is not perpendicular to the X-ray beam, the tooth will appear shorter than it really is.

Then there will be a difference between the measured length and the actual length of the tooth, and an accurate measurement cannot be made.

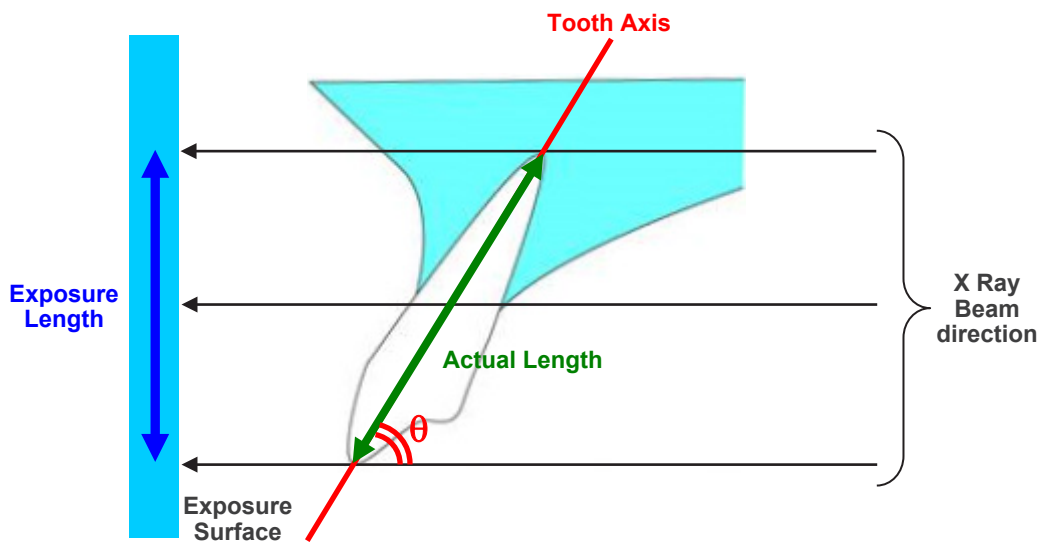

(3) CT Slice Images

CT slices may be distorted depending on the slice thickness and exposure artifacts. This is explained below.

Thickness of Slice Data

CT volume data is generated after the exposure. Then slices are made using the volume data. The slice images have a certain thickness.

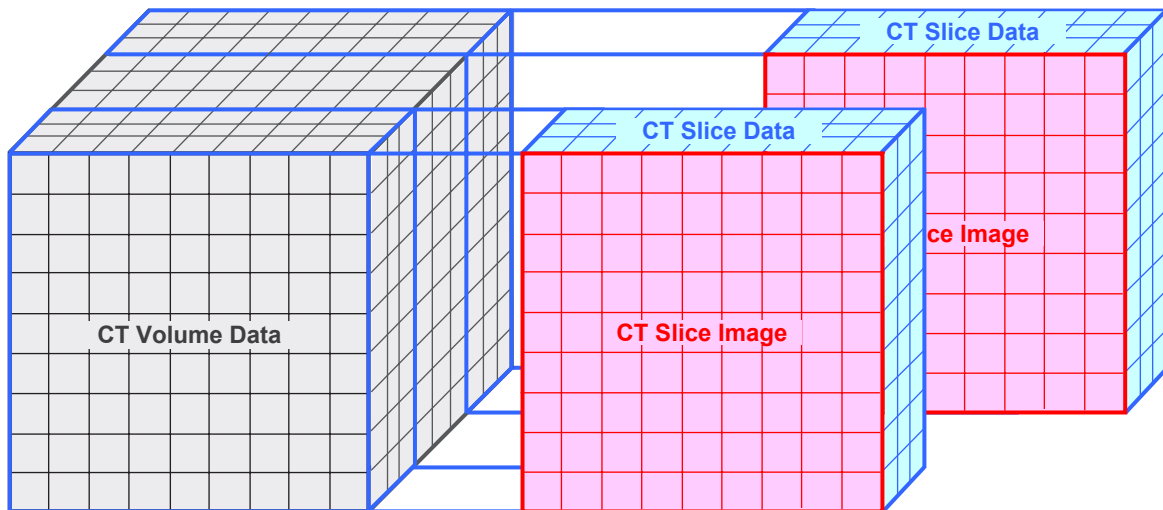

The thickness of the slices creates some distortion in the three dimensional quality of the CT slice data, and this is reflected in the slice image.

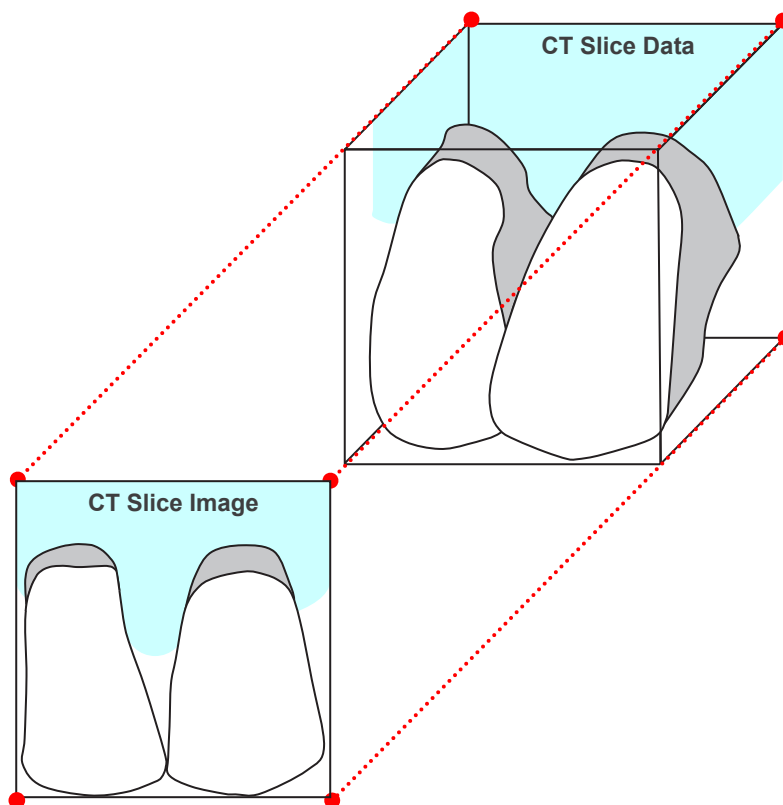

When measuring the target on a CT slice image which has been distorted by the thickness of the slice, the measurement error is only in the vertical direction.

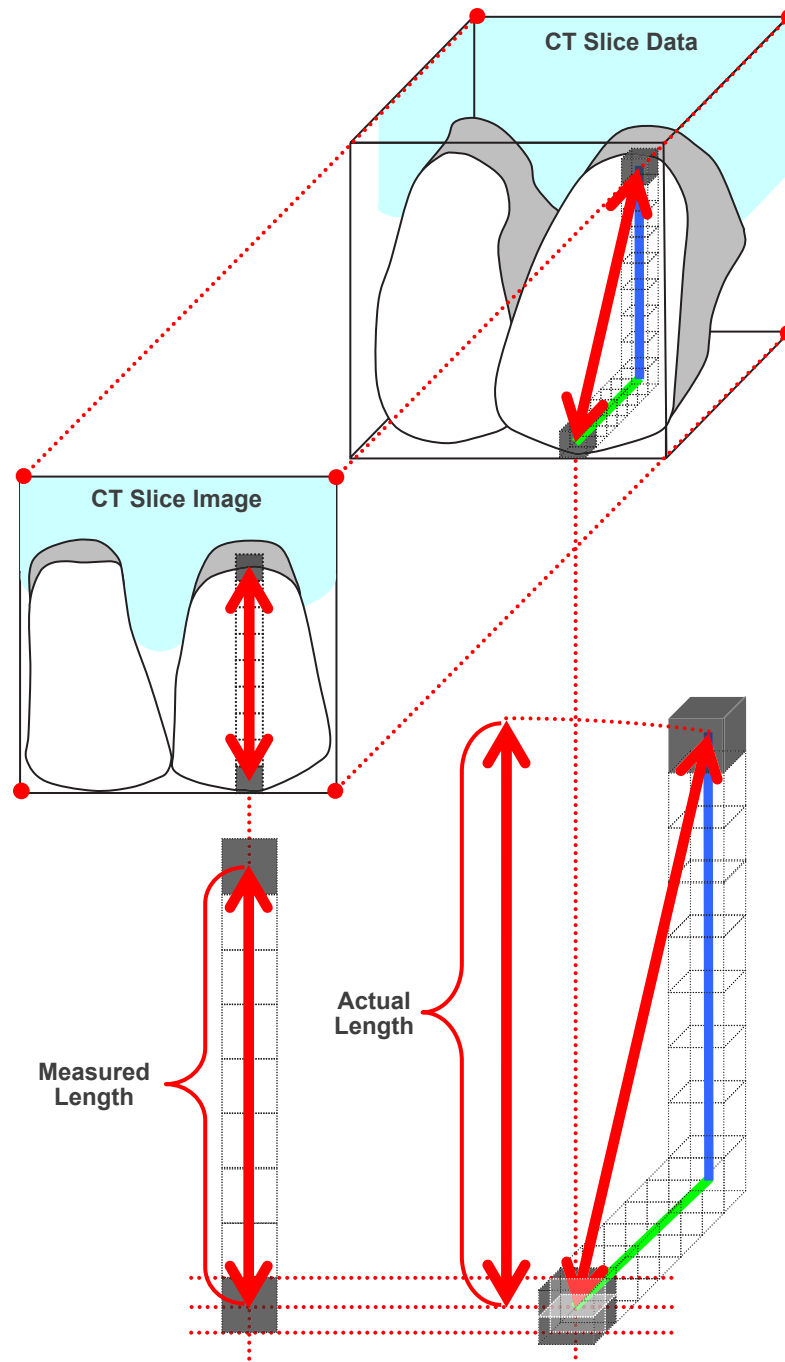

CT Exposure Artifacts

Artifacts generated during a CT exposure may cause distortion of the slice images. This distortion must be taken into consideration to make accurate measurements. For details, refer to the Cautionary Remarks on Imaging in the user manual of your X-ray equipment.

18. Application Information

Click the MORITA logo () on the upper right of the application to display the following dialogue window.

You can verify information about the software version, Net ID (license number), referring Patient Database, etc.

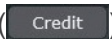
Click the Credit button () to see license information about open-source software involved with the i-Dixel WEB application.

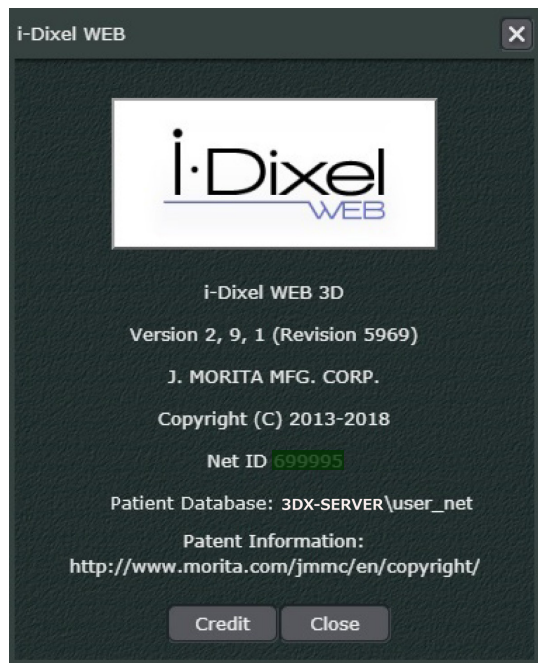

Importer and Distributor in European Union (EU)

J. MORITA EUROPE GMBH

Justus-von-Liebig-Strasse 27b, 63128 Dietzenbach, Germany

T +49. (0)6074. 836 0, F +49. (0)6074. 836 299

EU Authorized Representative under the European Regulation EU 2017/745



Medical Technology Promedt Consulting GmbH

Ernst-Heckel-Straße 7, 66386 St. Ingbert, Germany T +49. 6894 581020, F +49. 6894 581021

The authority granted to the authorized representative, Medical Technology Promedt Consulting GmbH, by J. MORITA MFG. CORP. is solely limited to the work of the authorized representative with the requirements of the European Regulation EU 2017/745 for product registration and incident report.



Development and Manufacturing

J. MORITA MFG. CORP.

680 Higashihama Minami-cho, Fushimi-ku, Kyoto 612-8533, Japan
T +81. (0)75. 611 2141, F +81. (0)75. 622 4595

Morita Global Website

www.morita.com

Distribution

J. MORITA CORP.

3-33-18 Tarumi-cho, Suita-shi, Osaka 564-8650, Japan
T +81. (0)6. 6380 1521, F +81. (0)6. 6380 0585

J. MORITA USA, INC.

9 Mason, Irvine CA 92618, USA
T +1. 949. 581 9600, F +1. 949. 581 8811

J. MORITA EUROPE GMBH

Justus-von-Liebig-Strasse 27b, 63128 Dietzenbach, Germany
T +49. (0)6074. 836 0, F +49. (0)6074. 836 299

MORITA DENTAL ASIA PTE. LTD.

150 Kampong Ampat #06-01A KA Centre, Singapore 368324
T +65. 6779. 4795, F +65. 6777. 2279

J. MORITA CORP. AUSTRALIA & NEW ZEALAND

Suite 2.05, 247 Coward Street, Mascot NSW 2020, Australia
T +61. (0)2. 9667 3555, F +61. (0)2. 9667 3577

J. MORITA CORP. MIDDLE EAST

4 Tag Al Roasaa, Apartment 902, Saba Pacha 21311 Alexandria, Egypt
T +20. (0)3. 58 222 94, F +20. (0)3. 58 222 96

J. MORITA CORP. INDIA

Filix Office No.908, L.B.S. Marg, Opp. Asian Paints, Bhandup (West), Mumbai 400078, India
T +91-82-8666-7482

J. MORITA MFG. CORP. INDONESIA

28F, DBS Bank Tower, Jl. Prof. Dr. Satrio Kav. 3-5, Jakarta 12940, Indonesia
T +62-21-2988-8332, F + 62-21-2988-8201

SIAMDENT CO., LTD.

71/10 Moo 5 T. Tharkham A. Bangpakong Chachuengsao 24130 Thailand
T +66 (0) 3857 3042, F +66 (0) 3857 3043
www.siamdent.com

Diagnostic and Imaging Equipment



Treatment Units



Handpieces and Instruments



Endodontic Systems



Laser Equipment



Laboratory Devices



Educational and Training Systems



Auxiliaries

